

# **PA-RISC 2.0 Firmware Architecture Reference Specification**

Version 1.1E

Printed in U.S.A. July 22, 2004

# Notice

The information contained in this document is subject to change without notice.

HEWLETT-PACKARD MAKES NO WARRANTY OF ANY KIND WITH REGARD TO THE MATERIAL, INCLUDING, BUT NOT LIMITED TO, THE IMPLIED WARRANTIES OF MERCHANTABILITY AND FITNESS FOR A PARTICULAR PURPOSE.

Hewlett-Packard shall not be liable for errors contained herein or for incidental or consequential damages in connection with furnishing, performance, or use of this material.

Hewlett-Packard assumes no responsibility for the use or reliability of its software on equipment that is not furnished by Hewlett-Packard.

This document contains proprietary information that is protected by copyright. All rights are reserved. No part of this document may be photocopied, reproduced, or translated to another language without the prior written consent of Hewlett-Packard Company.

Copyright © 1983-2003 by HEWLETT-PACKARD COMPANY All Rights Reserved

## 4. PDC Procedures

The objective of PDC is to provide a uniform, architected context in which to perform processor-dependent operations. One of the two PDC mechanisms is a software entry point which provides a variety of options to execute specific procedures. These procedures access processor-dependent hardware and return parameters that characterize or identify the processor.

PDC stands for Processor-Dependent Code, because the most natural implementation is via PA-RISC code stored in a processor ROM. This does not preclude special hardware support for PDC operations. Any of the PDC procedures may be performed by any combination of code and hardware. In particular, a support processor may be valuable in performing some PDC procedures.

All PDC procedures are provided as options to a single entry point called PDCE\_PROC. PDC is a per processor resource, and operating system software must be prepared to manage separate pointers to PDCE\_PROC for each processor. The address of PDCE\_PROC for the monarch processor is stored in the Page Zero location MEM\_PDC. The address of PDCE\_PROC for each non-monarch processor is passed in GR26 when PDCE\_RESET invokes OS\_RENDEZ. The procedure options are selected by the value of the index ARG0 in the call to PDCE\_PROC.

---

### ENGINEERING NOTE

A single copy of PDC may be shared between separate Category B processors, provided semaphores or other similar mechanisms are employed within PDC, so that each processor appears to have its own copy.

---

The calling conventions for PDC procedures are defined in Section 4.1. Section 4.2 contains a table listing all architected PDC procedures. It is followed by a set of pages giving specifications of the PDC procedures. The procedure pages appear in alphabetical order.

Some of the resources used by PDC procedures are system wide and not per processor. This is specified in the respective PDC procedures. When more than one processor module exists on a system, each processor module must return its associated value for per processor resources. For access to system-wide resources, the same value must be returned no matter on which processor the PDC procedure is called.

For all the PDC procedures there is no change in the architecturally visible module state, except where changes have been specified in the respective PDC procedures and calling conventions.

The architected operation of a module (including execution of PDC) must not require the use of any non-architected PDC procedures. It must also not require the use of any non-architected options in architected PDC procedures.

The converse is also true: the execution of a non-architected PDC procedure (or a non-architected option of an architected procedure) must not affect the architected operation of a module.

PDC procedures must not call IODC entry points.

PDC procedures for PA-RISC 2.0 processors may be called in either narrow (PSW W-bit = 0) or wide (PSW W-bit = 1) mode. Generally OSes which support only 32-bit applications, data, and addressing will call PDC in narrow mode, while OSes that support 64-bit applications, data, and addressing will call PDC in wide mode. The mode of the PDC call is determined by the current W-bit setting at the time of the call. Calls made in narrow mode will use the PA-RISC 1.1 calling conventions, and the PDC procedures will return the same results as defined for the PA-RISC 1.1 PDC procedures. Calls made in wide mode will use the PA-RISC 2.0 calling conventions, and the PDC procedures will return 64-bit results. Details of the PA-RISC 2.0 calling conventions and functional descriptions of the PA-RISC 2.0 PDC procedures follow in this chapter. This information is presented in a format that does not require the reader to be familiar with PA-RISC 1.1 conventions and specifications.

There is one exception to the general rule of PA-RISC 2.0 hardware not having an affect on PA-RISC 1.1 procedure calls. This exception is PDC\_PIM. The memory layout of the buffer pointed to by *memaddr* has been expanded to allow full 64-bit entities (registers and addresses) to be returned, even when PDC is running in narrow mode.

## 4.1 Calling Conventions

The PDC procedures provide a procedural interface to module-type dependent code for processors. The calling convention used for these procedures is a subcase of the one defined in **64-Bit Runtime Architecture for PA-RISC 2.0** by Cary Coutant of California Language Lab. This calling convention allows high level language code to call PDC.

The applicable portions of the calling convention are summarized here; refer to Cary's paper for details. This subset of the calling convention used by PDC is frozen in the I/O Architecture. Indirect calls through special stubs will be required if the convention changes in the future.

In addition to the specific conventions listed in the following sections of this chapter, all PDC procedures which are called while the OS is in control of the system should be loaded into and run from memory. Only the PDC entry points which are triggered by a hardware event should be executed from ROM in I/O space. In addition, code which is run from I/O space should not execute PTLB instructions, as this could cause a system hang.

These calling conventions do not apply to the PDC entry points triggered by TOC, reset, or machine checks.

### 4.1.1 Processor State

The processor must be in the following state when PDC procedures are called:

- The processor must be at Privilege Level 0 at entry, during the PDC procedure call, and at exit.
- The Interruption Vector Table (IVT) is defined by the caller at entry. PDC procedures must not write to the IVT. When the PDC procedure is exited, the IVT must have the same value it had when the procedure was entered.

The following table defines the requirements for the Processor Status Word (PSW) at entry to, during, and at exit from a PDC procedure call. The terms used in the definition of the requirements have the following meaning:

Definition of entry and exit:

Entry        Start of the first instruction of the PDC procedure.

Exit         Start of the first instruction after return to caller's code.

Terms used to define entry and exit values:

0        Must be set to 0 at entry to or exit from the procedure.

1        Must be set to 1 at entry to or exit from the procedure.

C        The state of bits marked with C are defined by the caller. If the value at exit is also C, it must be the same as the value at entry.

X        Don't care. On entry, the caller may set these bits to any value. The PDC procedure must not attribute any meaning to the state of these bits. On exit, the PDC procedure may set these bits to any value. The caller must not attribute any meaning to the state of these bits.

Terms used to define allowed actions during execution of the PDC procedure.

Unchanged    The PDC procedure must not change these bits from their entry values at any time during execution of the procedure.

Unspecified    There are no requirements on the state of these bits. The PDC procedure may modify them as necessary during execution of the procedure.

Restored        The PDC procedure may modify these bits as necessary during execution of the procedure, however, they must be restored to their entry value prior to exit from the procedure.

State requirements for the Processor Status Word:

PSW Bit	Entry Value	During PDC Execution	Exit Value	Name
S <sup>1</sup>	C	Unchanged	C	Secure Interval Timer
T	0	Unchanged	0	Taken Branch Trap Enable
H	0	Unchanged	0	Higher Privilege Transfer Trap Enable
L	0	Unchanged	0	Lower Privilege Transfer Trap Enable
N <sup>2</sup>	0	Unspecified	0	Nullify
X <sup>2</sup>	0	Unspecified	0	Data Memory Break Disable
B <sup>2</sup>	0	Unspecified	0	Taken Branch
C	0	Unchanged	0	Code Address Translation Enable
V <sup>3</sup>	X	Unspecified	X	Divide Step Correction
M	0 <sup>4</sup>	Restored	0 <sup>4</sup>	High Priority Machine Check Mask
C/B <sup>3</sup>	X	Unspecified	X	Carry/Borrow Bits
R	0	Unchanged	0	Recovery Counter Enable
Q	1	Restored	1	Interrupt State Collection Enable
P <sup>1</sup>	C	Restored	C	Protection Identifier Validation Enable
D	0	Unchanged	0	Data Address Translation Enable
I	0	Unchanged	0	Ext, P-fail Interrupt, LPMC Unmask
E <sup>5</sup>	0	Unchanged	0	Little-Endian Enable
F	0	Unchanged	0	Performance Coprocessor Enable
G <sup>6</sup>	0	Unchanged	0	Debug Trap Enable
Y <sup>6</sup>	0	Unchanged	0	Data Debug Trap Disable
Z <sup>6</sup>	0	Unchanged	0	Instruction Debug Trap Disable
W <sup>7</sup>	C	Restored	C	Wide Address Formation Enable
O <sup>8</sup>	C	Restored	C	Ordered Memory References

Notes

1. These bits are Defined by the caller. Their value at exit must be the same as their value at entry.
2. These bits are changed by normal instruction execution. They will be 0 on entry and exit from the PDC procedure. No action is required by the caller.
3. These bits are set by arithmetic instructions during normal execution. No Action is required by the caller.
4. Except when PDC\_PIM is called with ARG1=0, in which case the M-bit must be 1.
5. Regardless of the endianness of the OS, PDC procedures are defined to run in big endian mode. The OS is responsible for any data swapping and stack management required before and after PDC procedure calls.
6. These bits are implemented only on level 0 processors which also implement the debug SFU. In all other cases they are reserved bits.
7. The W-bit determines whether PDC is called in wide (64-bit) address mode (W=1), or narrow (32-bit) address mode (W=0). If the W-bit is set to one, the caller must use PA-RISC 2.0 calling conventions. If the W-bit is zero, the caller must use PA-RISC 1.1 calling conventions. If the processor does not implement wide address mode (a PA-RISC 1.1 processor) the W-bit is reserved.
8. The O-bit is defined for PA-RISC 2.0 processors only. On PA-RISC 1.1 processors the O bit is reserved.

## 4.1.2 Register State

The following four tables define the requirements for the State of the Control Registers, Space Registers, General Registers, and Floating Point Registers at entry to, during, and at exit from a PDC procedure call. The terms used in the definition of the requirements have the following meaning:

Terms used to define entry and exit state:

- C Defined by the Caller. The value at entry is defined by the caller of the PDC procedure. If the value at exit is also defined by caller, it must be the same as the value at entry.
- HV HVERSION (processor) dependent. The value, if it exists, is dependent on the HVERSION of the processor. It must not be used by the PDC procedure or its caller.
- X Don't Care. On entry, the caller of the PDC procedure may set the register to any value. The PDC procedure must not attribute any meaning to the value. On exit, the PDC procedure may set the register to any value.

The caller must not attribute any meaning to the value.

- U The value of the register is not defined for either the PDC procedure on entry or the caller on exit from the procedure.
- V The value at exit is a result obtained by execution of the PDC procedure.

The terms used to define allowed actions during execution of the PDC procedure are the same for Registers as for PSW bits, with the following additions:

- Set Result During the PDC procedure call a result is placed in the register prior to exit.
- Unused The PDC procedure is not allowed to write to or rely on the value in the register. However the register may not contain the value at entry during the entire call and at exit.

Register state requirements for Control Registers:

CR No.	Entry Value	During PDC Execution	Exit Value	Name
0	C	Unchanged	C	Recovery Counter
1-7	HV	Undefined	HV	None (HVERSION Dependent)
8	C	Unchanged	C	Protection IDs 1 and 2
9	C	Unchanged	C	Protection IDs 3 and 4
10	C	Unchanged/ Set Result <sup>1</sup>	C/V	Coprocessor Configuration Register/ SFU Configuration Register
11	C	Unspecified	X	Shift Amount Register
12	C	Unchanged	C	Protection IDs 5 and 6
13	C	Unchanged	C	Protection ID 7 and 8
14	C	Unchanged/ Restored <sup>2</sup>	C	Interrupt Vector Address
15	C	Restored	C	External Interrupt Enable Mask
16	C	Unused <sup>3</sup>	C <sup>3</sup>	Interval Timer
17	U	Unused	U	Interrupt Instruction Address Space Queue
18	U	Unused/ Unspecified <sup>4</sup>	U	Interrupt Instruction Address Offset Queue
19	U	Unused	U	Interrupt Instruction Register
20	U	Unused	U	Interrupt Space Register
21	U	Unused	U	Interrupt Offset Register
22	U	Unused/ Unspecified <sup>4</sup>	U	Interrupt Processor Status Word
23	C	Unchanged	C	External Interrupt Request Register
24-31	C	Unused/ Restored <sup>5</sup>	C	Interrupt handler Use

Notes:

1. The only PDC procedure that is allowed to read from or write into the Coprocessor Configuration Register/SFU Configuration Register (CR 10) is PDC\_COPROC. The exit state of CR 10 is either the value at entry, or the value *ccr\_functional* provided by PDC\_COPROC.
2. PDC Procedures may write to the IVA (CR 14) only if they handle their own interruptions. The address of the PDC procedure's interruption handlers is written to CR 14. The caller's interruption handler must be restored before returning to the caller.
3. No called PDC procedure is allowed to write to the Interval Timer(CR 16). The value at exit is the value at entry plus the elapsed time of the procedure call.
4. PDC procedures may write to CR 18 and CR 22 when it is necessary for them to modify PSW bits. Only the PSW bits to be changed may be written to CR 22. A Return From Interruption (RFI) instruction must be executed as early as possible following the writes to CR 18 and CR 22 to reduce the probability of the value written to these registers by the PDC procedure being destroyed by an interruption.

---

**PROGRAMMING NOTE**

It is recommended that an RFI instruction immediately follow writes to CR 18 and CR 22.

---

5. CR 24 through CR 31 are defined for interruption handler use. If a PDC procedure handles its own interruptions, the handler may use these registers for temporary storage. In any case, PDC must restore the original contents before returning to the caller.

Register state requirements for Space Registers:

SR No.	Entry Value	During PDC Execution	Exit Value
0-2	X	Unspecified	X
3-7	C	Restored	C

Register state requirements for General Registers:

GR No.	Entry Value	During PDC Execution	Exit Value	Usage
0	0	Unchanged	0	Zero
1	X	Unspecified	X	Temporary storage (scratch)
2	C	Unspecified <sup>1</sup>	X	Return Address of caller
3-18	C	Restored	C	Temporary storage (callee saves)
19	C	Unspecified	X	ARG7
20	C	Unspecified	X	ARG6
21	C	Unspecified	X	ARG5
22	C	Unspecified	X	ARG4
23	C	Unspecified	X	ARG3
24	C	Unspecified	X	ARG2
25	C	Unspecified	X	ARG1
26	C	Unspecified	X	ARG0
27	C	Restored	C	Defined by caller
28	X	Set Result	V	Return Status
29	X	Unspecified	X	Unspecified
30	C	Restored	C	Caller Stack Pointer
31	X	Unspecified	X	Temporary storage (scratch)

Notes:

- The PDC Procedure may modify GR 2 as necessary during execution, and the caller may not rely on the contents of GR 2 after the call. The PDC procedure must maintain the value passed in GR2 by the caller to use as a return address after the call completes.

Register state requirements for Floating Point Registers:

FPR No	Entry Value	During PDC Execution	Exit Value
0	C	Unchanged/ <sup>1</sup> Set Result	C/V/HV <sup>1</sup>
1-31	C	Unchanged/ <sup>1</sup> Unspecified	C/HV <sup>1</sup>

Notes:

- The floating point registers FPR0 through FPR31 are defined by the caller at entry and must be unchanged by all procedures except PDC\_COPROC. When PDC\_COPROC exits, the values of FPR 0 through FPR 31 are all HVERSION dependent except for the T bit of FPR 0. The T bit of FPR0 returns the test status and must be set to 0 if the test succeeds.



### 4.1.3 Stack Usage

The caller of PDC procedures must provide a doubleword-aligned value in GR 30, the Stack Pointer (SP), which points to the following data:

SP - 96	SAVE_ARG7
SP - 88	SAVE_ARG6
SP - 80	SAVE_ARG5
SP - 72	SAVE_ARG4
SP - 64	SAVE_ARG3
SP - 56	SAVE_ARG2
SP - 48	SAVE_ARG1
SP - 40	SAVE_ARG0
SP - 32	frame marker
SP	temporary storage

The values of SAVE\_ARG0 through SAVE\_ARG7 are defined by the caller at entry, and are unspecified at exit. They are used to save the first eight arguments to the procedure, which are passed to the procedure in registers GR26 through GR19, respectively. Additional arguments are passed on the stack in successive locations (ARG8 at SP-104, ARG9 at SP-112, ARG10 at SP-120, etc.)

When the called procedure returns, the value of SP must be restored. The memory at the Stack Pointer address SP and the next 7K bytes of larger physical addresses are available for temporary use by the called procedure. If the called procedure is PDC\_POW\_FAIL, the memory at the Stack Pointer address SP and the next 512 bytes of larger physical addresses are available for use by PDC\_POW\_FAIL.

### 4.1.4 Arguments

The procedure to be performed is selected by the index **ARG0**. ARG0 is not explicitly listed in the procedure specifications that follow. The ARG0 value for all PDC procedures is a 64-bit unsigned integer.

The option of the procedure is selected by **ARG1**. For architected PDC procedures, options 0 through 127 are architected or reserved; options (128 through 0xFFFFFFFF) are for HVERSION-dependent use, options above 0x100000000 are reserved. For HVERSION-dependent PDC procedures, all options are for HVERSION-dependent use. The ARG1 value for all PDC procedures is a 64-bit unsigned integer.

Many PDC procedures use the standard argument *R\_addr* to designate the return parameter buffer. This buffer is a doubleword-aligned block of 32 doublewords allocated by the caller. The procedure can return parameters to its caller by storing into the buffer. If the *R\_addr* argument is provided, it is always **ARG2**.

In the procedure specifications that follow, the notation 'R' is used to indicate an argument passed to a PDC procedure which is reserved for future extensions. Reserved arguments must be set by all current callers to 0, and must be ignored by all current callees. Reserved arguments may be architected in the future, with the value 0 defined to preserve compatibility with previous versions.

The notation 'HV' is used to indicate that the value of the argument is not specified by the architecture and so may be freely chosen by the caller. By contrast, arguments denoted by '---' are nonexistent: the caller is not required to provide such arguments at all. Callees must not attach any significance to 'HV' arguments and must not attempt to access '---' arguments.

All address parameters which are passed as arguments or are returned as parameters are 64-bit unsigned integers. The alignment restrictions for these address parameters are specified in each of the PDC procedures.

All signed integers are represented in two's complement (64-bit) format.

#### 4.1.5 Return Parameters

If a PDC procedure returns parameters to its caller, they are stored in the return parameter buffer specified by *R\_addr*. The 32 returned parameters are called RET[0] through RET[31]. At least RET[0] through RET[15] are designated for architected return parameters. Return parameters in RET[16] through RET[31] which are not architecturally defined may be used for HVERSION-dependent purposes. All return parameters neither architected nor used for HVERSION-dependent purposes must be set to 0 by the PDC procedure upon return. The notation 'R' indicates a return value that must be set to 0 by the PDC procedure. The notation '---' indicates that the PDC procedure does not return any parameters.

If a PDC implementation defines a new dependent return word for a procedure, the value 0 must be used to indicate "not implemented" to preserve compatibility with previous versions.

For HVERSION-dependent PDC procedures and HVERSION-dependent options of architected PDC procedures, all 32 return values (RET[0] through RET[31]) are HVERSION dependent.

#### 4.1.6 Status

The status of PDC procedures is returned as a 64-bit two's complement signed integer value in register GR28.

The rest of this section applies only to architected options of architected PDC procedures. For HVERSION-dependent PDC procedures and HVERSION-dependent options of architected PDC procedures, all status values are HVERSION dependent.

The following status values have the same meaning for all PDC procedures to which they apply:

Value	Description
3	Call completed with a warning
0	OK
-1	Nonexistent procedure
-2	Nonexistent option
-3	Cannot complete call without error
-10	Invalid argument
-12	BUS_POW_WARN assertion detected
-37	Invalid PDC entry point

Note that status -1 is actually returned by PDCE\_PROC, the entry point for all PDC procedures, rather than by the individual PDC procedures themselves.

Positive status values (values from 1 to 0x7FFFFFFF FFFFFFFF) are used to report advisory information whose meaning is dependent on the procedure that was called.

The negative value -37 is used on cellular systems when the PDC\_PROC entry point supplied by the OS is not valid. The OS must call PDC on the same cell where the PDC resides. The entry point is passed to the OS in GR26 on all non-monarch processors.

Negative values -2, -3, -10 and -12 are returned by the individual PDC procedure, but have the same meaning for all procedures.

All other negative status values are used for errors whose meaning is dependent on the procedure that was called.

Status values other than those listed for a PDC procedure are reserved. Each PDC procedure may return only the values specifically defined for it. Reserved values can be assigned architected meanings in the future. Therefore, callers must treat the reserved negative values the same as -3 (Cannot complete call without error) and the reserved positive values the same as 0 (OK).

Some status values are marked as **REQUIRED**. This means that all implementations of the PDC procedure are required to detect the condition specified by the status value and to return the status value whenever the condition is detected. Values are designated as required when necessary to support the functionality of the procedure.

Some status values are marked as **OPTIONAL**. This means that each implementation of the PDC procedure can choose whether or not it will detect the condition specified by the status value.

Some status values are marked as **CONDITIONAL**. These values are accompanied by a specification of the cases in which the condition must be detected and reported. There will be some PDC implementations for which those cases do not apply; they must not use the given value at all.

---

#### **ENGINEERING NOTE**

It is expected that those PDC implementations that are able to detect optional conditions will do so (and will return the appropriate status value).

PDC implementations are encouraged to recognize as many specific error conditions as they can.

---

If an implementation cannot isolate an error to one of the more specific conditions, then it must report the error by returning the general status value -3 (indicating that an indeterminate error was detected). If it cannot isolate one of the specific advisory conditions, then it must return status 0 for "OK".

For all PDC procedures:

- All RET values are valid with a zero return status.
- All RET values are valid with any positive return status unless specified otherwise in the respective PDC procedure description.
- All RET values are HVERSION dependent with a negative return status.

### **4.1.7 Interruptions**

PDC procedures may optionally handle their own interruptions.

If PDC procedures do not handle their own interruptions, the execution of PDC procedures must not cause any Group 3 or Group 4 interruptions. If PDC procedures do not handle their own interruptions, they must not write to CR14 or to CR24 through CR31 during the procedure call.

If PDC procedures handle their own interruptions, they must write to CR 14 during the procedure call to point to their interruption handlers. They may optionally modify the contents of CR 24-31 in accordance with their interruption handlers. The interruption handlers must not modify those registers which the PDC procedures are not allowed to modify.

PDC procedures are not required to recover if they receive an HPMC.

---

#### **ENGINEERING NOTE**

It is recommended that all PDC procedures be re-entrant to help them recover from an HPMC. The probability of receiving an HPMC during a PDC procedure call is considered sufficiently low that PDC procedures are not required to be re-entrant.

---

### **4.1.8 Powerfail Warning on Central Bus during PDC Call**

In the event of a powerfail warning on the central bus while a PDC call is in progress, the procedure must always return quickly enough so that the caller has the full powerfail budget available. PDC\_CHASSIS and PDC\_POW\_FAIL must complete all required actions before returning. All PDC procedures except PDC\_CHASSIS and PDC\_POW\_FAIL have two choices in the event of a powerfail warning on the central bus:

- complete all required actions before returning with the appropriate status
- terminate the call prematurely and return -12

A PDC procedure that returns -12 must be restartable, that is, it can be re-executed by the caller.

---

#### PROGRAMMING NOTE

The recommended calling sequence for restartable PDC procedures follows:

```
while ( 1 ) {
    PSW I-bit ← 0;
    status ← PDC_xxxxx ( <arguments> );
    if (status != -12)
        break;
    PSW I-bit ← 1;
}
```

## 4.2 PDC Procedures

When PDCE\_PROC is called, the index ARG0 specifies the procedure to be performed, as shown below:

ARG0	Mode	Name	Description
0	R		Obsolete
1	HV	PDC_POW_FAIL	Prepare for powerfail
2	A	PDC_CHASSIS	Update chassis display
3	A	PDC_PIM	Access Processor Internal Memory
4	A	PDC_MODEL	Return processor model information
5	A	PDC_CACHE	Return cache and TLB parameters
6	A	PDC_HPA	Return processor's HPA
7	A	PDC_COPROC	Return coprocessor configuration
8	A	PDC_IODC	Access a module's IODC
9	A	PDC_TOD	Access Time-Of-Day clock
10	A	PDC_STABLE	Access Stable Storage
11	HV <sup>1</sup>	PDC_NVOLATILE	Access Non-Volatile Memory
12	A	PDC_ADD_VALID	Validate address
13	R		Obsolete
14	R		Obsolete
15	R		Obsolete
16	A <sup>2</sup>	PDC_PROC	Stop the currently executing processor
17	HV <sup>3</sup>	PDC_CONFIG	Deconfigure and reconfigure a module
18	R		Obsolete
19	HV <sup>4</sup>	PDC_TLB	Manage hardware TLB miss handling
20	HV	PDC_MEM	Manage per page memory deallocation
21	HV <sup>5</sup>	PDC_PSW	Manage default PSW bits
22	HV	PDC_SYSTEM_MAP	Map fixed location IO modules
23	HV	PDC_SOFT_POWER	Manage software power control
24	HV <sup>6</sup>	PDC_ALLOC	Allocate IODC data storage
25	A	PDC_CRASH_PREP	Prepare I/O System for crash dump
26	A	PDC_SCSI_PARAMETERS	Manage SCSI Initialization Params
27	A	PDC_ACPI	Return ACPI table
28-127	R		Reserved
128-511	HV <sup>7</sup>		HVERSION dependent
> 511	R		Reserved

- R the procedure index is Reserved
- A the procedure is required by the architecture in all PDC implementations
- HV the existence of the procedure depends on the HVERSION of the processor

### Notes:

1. Required for processors that provide Non-Volatile Memory; not implemented by other processors.
2. Required for Category B processors; not implemented by Category A processors.
3. Required for processors that support module deconfiguration; not implemented by other processors.
4. Required for processors with hardware TLB miss handlers; not implemented by other processors.
5. Required for processors which implement the E-bit or W-Bit; not implemented by other processors.
6. Required for processor whose IODC firmware require allocated data storage; not required for other processors.
7. Indices 128 through 504 are intended for released products and are coordinated by Systems Architecture. Indices 505 through 511 are intended for product development only. They are controlled completely within the development teams, and should never appear in released products or generic software.

If an implementation provides a PDC procedure, then it must provide all defined options for that procedure, unless explicitly noted to the contrary under the "**Options**" heading in the specifications that follow.

## PDC\_ACPI (index 27)

**Purpose:** To return a table contain ACPI information to the Operating System software.

Arguments:	Description	ARG1	ARG2	ARG3	ARG4	ARG5	ARG6
	Return ACPI table	0	R_addr	table	index	memaddr	count

Returns:	Description	RET[0]	RET[1]	RET[2]	RET[3]
	Get entry point	actcnt	R	R	R

Status:	Value	Description
	3	Call completed with a warning. An error of unspecified type occurred, but the call completed correctly. OPTIONAL. The procedure need not report warning conditions.
	0	OK The call completed normally and the procedure detected no error. REQUIRED.
	-2	Nonexistent option ARG1 did not correspond to an option provided by the procedure. REQUIRED.
	-3	Cannot complete call without error An error of unspecified type prevented the call from completing correctly. CONDITIONAL. Must be used if indeterminate errors can be detected.
	-4	Invalid table name. The table name passed in ARG1 is not a supported ACPI table. REQUIRED.
	-5	Valid ACPI table name, but <i>index</i> was invalid for this table. REQUIRED. Returned if <i>index</i> is larger than the extent of the table.
	-10	Invalid argument An argument other than ARG0 or ARG1 was invalid. OPTIONAL. The procedure need not check arguments for correctness.
	-12	Assertion of BUS_POW_WARN signal detected CONDITIONAL. Must be used if the procedure cannot satisfy the powerfail budget.

**Description:** The **Return ACPI table** option returns the ACPI table referenced in ARG3 from firmware to the Operating System. ARG3 is an 8 character ASCII variable giving the name of the table to be returned. The format of the argument is the 4 character table name followed by 4 blanks. The only table supported at this time is the SPMI table, indicated by "SPMI ". This table is described on the System Architecture website in the "HP ACPI Implementation" section.

ACPI Table Implementations on PA-RISC should all be in Big Endian format. This means that all numeric or logical quantities should be loaded from memory with the same size attribute as stated in the spec (2 byte quantities with a halfword load, 4 byte quantities with a word load, 8 byte quantities with a doubleword load, etc), and that character strings are read from left to right in increasing byte sequence in memory, and from left to right when multiple characters are loaded into a register with a multi byte load.

The table contents are copied into the memory buffer referenced by *memaddr*, starting at the offset into the table given by the *index* input variable. The *count* input argument gives the size of the memory buffer passed in *memaddr*.

The *actcnt* return parameter denotes the actual number of bytes of data copied into the memory buffer. The value of *actcnt* must be less than or equal to the value of *count*. If *actcnt* is equal to *count*, then more data may remain to be copied. Otherwise the copy is complete. The minimum architected buffer size is 4 KB. If the ACPI table copied is greater than 4 KB, then the *offset* argument should be incremented by the buffer size and the copy repeated until *actcnt* is less than *count*.

## PDC\_ADD\_VALID (index 12)

**Purpose:** To determine the correct completion of a READ operation without risking an HPMC.

**Arguments:**

Description	ARG1	ARG2
Validate address	0	phaddr

**Status:**

Value	Description
3	Call completed with a warning. An error of unspecified type occurred, but the call completed correctly. OPTIONAL. The procedure need not report warning conditions.
2	Operation completed with a requestor bus error REQUIRED.
1	Operation completed with a requestor bus error REQUIRED.
0	OK (Operation completed without bus error) The call completed normally and the procedure detected no error. REQUIRED.
-2	Nonexistent option ARG1 did not correspond to an option provided by the procedure. REQUIRED.
-3	Cannot complete call without error An error of unspecified type prevented the call from completing correctly. CONDITIONAL. Must be used if indeterminate errors can be detected.
-10	Invalid argument An argument other than ARG0 or ARG1 was invalid. OPTIONAL. The procedure need not check arguments for correctness.
-12	Assertion of BUS_POW_WARN signal detected CONDITIONAL. Must be used if the procedure cannot satisfy the powerfail budget.

**Description:** The "Validate address" option (ARG1=0) allows the caller to determine if a READ to *phaddr* would generate a requestor bus error without risking an HPMC. PDC\_ADD\_VALID generates a READ operation by issuing a load instruction to *phaddr*. The *phaddr* argument is a doubleword-aligned, 64-bit physical address.

PDC\_ADD\_VALID must return either 1 or 2 when detecting an HPMC fault condition caused by a requestor bus error. PDC\_ADD\_VALID may return either status value, so the caller must check for both values. It must also return one of these values when called for a deconfigured module which does not normally assert PATH\_SLAVE\_ACK in that state.

For processors that do not implement the full 64-bit address space, PDC\_ADD\_VALID must perform a simple address comparison to check that *phaddr* is within the implemented address space. PDC\_ADD\_VALID must not try to determine the validity of a given physical address by attempting a READ before this test is successful. If *phaddr* is in the unimplemented portion of the address space, PDC\_ADD\_VALID must return either 1 or 2.

If PDC\_ADD\_VALID detects an HPMC condition other than a requestor bus error, it is required to return one of the following status values: 2, 1, 0, or -3. Status value 0 indicates that the HPMC condition did not interfere with the completion of the READ operation. Status value -3 indicates that the HPMC condition interfered with the completion of the READ operation (that is: PDC\_ADD\_VALID could not determine that the read to *phaddr* completed). Status values 1 or 2 may optionally be used when an HPMC condition occurs other than a requestor bus error.

PDC\_ADD\_VALID may optionally enter its caller's HPMC handler when detecting an HPMC condition other than a requestor bus error.



---

**SUPPORT NOTE**

Implementations of PDC\_ADD\_VALID are encouraged to use status values 0 or -3 for HPMC conditions other than requestor bus errors. Support organizations will decide whether or not an implementation is allowed to use the status values 2 or 1 for these HPMC conditions. This decision is based on the supportability, reliability, and availability requirements of the particular product.

---

---

**PROGRAMMING NOTE**

Calls to PDC\_ADD\_VALID may cause soft errors to be logged in the lower ports of bus converters involved in the READ operation. Therefore, the caller may wish to issue a CMD\_CLEAR to any bus converter ports that may have been affected. Issuing CMD\_CLEAR is optional, but future error isolation is hampered by having bus converter ports with residual soft errors logged during prior calls to PDC\_ADD\_VALID.

---

## PDC\_ALLOC (index 24)

**Purpose:** To allocate static data storage for IODC use.

Arguments:	Description	ARG1	ARG2	ARG3	ARG4	ARG5
	Allocate Storage	0	R_addr	Size	High_mem_flag	AllocPtr
	Get Allocation Ptr	1	R_addr	R	R	R
	Free Storage	2	R_addr	Address	R	R
	Free Tagged Storage	3	R_addr	AllocPtr	R	R
	Free All Storage	4	R_addr	R	R	R

Returns:	Description	RET[0]
	Allocate Storage	Storage_address
	Get Allocation Ptr	AllocPtr

Status:	Value	Description
	1	Storage request not aligned to cache-line boundary. Storage returned was rounded up to the next larger cache-line boundary. REQUIRED.
	0	OK The call completed normally and the procedure detected no error. REQUIRED.
	-2	Nonexistent option ARG1 did not correspond to an option provided by the procedure. REQUIRED.
	-3	Cannot complete call without error An error of unspecified type prevented the call from completing correctly. CONDITIONAL. Must be used if indeterminate errors can be detected.
	-4	Insufficient Storage There was not enough storage available to satisfy the request. CONDITIONAL. Must be used if only low memory is allocated.
	-10	Invalid argument An argument other than ARG0 or ARG1 was invalid. OPTIONAL. The procedure need not check arguments for correctness.
	-11	Out of available low memory space No more memory remains to be allocated in the low memory region. CONDITIONAL. Must be used if both low and high memory is allocated.
	-12	Assertion of BUS_POW_WARN signal detected CONDITIONAL. Must be used if the procedure cannot satisfy the power-fail budget.
	-13	Out of allocation nodes. No more allocation nodes are available to allocate memory. CONDITIONAL. Must be used if both low and high memory is allocated.
	-14	Attempt to free an address no previously allocated The address passed to the free option was not previously allocated. CONDITIONAL. Must be used if the <b>Free Storage</b> option is implemented.
	-15	No AllocPtr is available. No allocation pointed is available. CONDITIONAL. Must be used if both low and high memory is allocated.
	-16	Attempt to free storage with an invalid AllocPtr. An attempt was made to free storage using an Alloc pointer when did not point to previously allocated storage. CONDITIONAL. Must be use if the Free Tagged Storage option is implemented.

**Description:** The PDC\_ALLOC procedure is used to allocate storage outside of the memory areas managed by the OS. This storage is usually reserved by IODC, although diagnostic software can also allocate

storage. This storage remains available even after OS boot, as it is in memory areas reserved by PDC. At least 32 K bytes of storage is available in low memory. Platforms that implement only low memory need only implement option 0, **Allocate Storage**. If additional memory is made available, it will be allocated in high memory. In this case, PDC\_ALLOC must also implement options 1 through 4. The size of the high memory area is not architecturally set, but 1 MB is a recommended minimum. On cellular systems, the high memory allocations are made from cell local memory.

32-bit I/O cards may only use the low memory area. The high memory area requires 64-bit cards. Therefore, the caller should try to allocate high memory first, and should only allocate low memory either if the caller cannot use high memory (32-bit card) or high memory is not available.

The "**Allocate Storage**" option (ARG1=0) is used to allocate static storage for use by IODC. If high memory is allocated, it may be freed by calling the appropriate free storage option. If low memory is allocated, the storage can not be freed, therefore its use should be limited to once per boot for a particular user. The single exception to this rule is that boot storage may be freed by zeroing the architected locations in page zero.

The *Size argument* denotes the size of the allocation requested. The *High\_mem\_flag* denotes whether high memory is acceptable. It is an unsigned 64-bit integer. A value of 0 indicates that only low memory is acceptable. A value of 1 indicates that high memory is acceptable. All other values are reserved. The *AllocPtr* argument is used to tag an allocation for subsequent freeing using the Free Tagged storage option. It is a 64-bit pointer. If a value of 0 is used, the storage is not tagged. If IODC allocates storage which must later be freed by PDC, then an AllocPtr should be obtained and used to tag that storage.

The address of the storage area allocated is returned in the *Storage\_address* return parameter.

The allocation request should be in cache line increments or larger. The storage returned will be cache line aligned.

---

#### PROGRAMMING NOTE

Space allocation for low memory should be done once for each device only by calling PDC\_ALLOC from within ENTRY\_INIT. For the console and keyboard devices, space allocation may be done once per boot only. Console and Keyboard ENTRY\_INIT should check the page zero locations for IODC\_CONS\_BASE and IODC\_CONS\_SIZE or IODC\_KBRD\_BASE and IODC\_KBRD\_SIZE. If the values are non-zero, ENTRY\_INIT should use the values in page zero. If the values are zero, ENTRY\_INIT should call PDC\_ALLOC to reserve storage, and should write the size and address to the appropriate page zero locations. Note that it is the caller, not PDC\_ALLOC's responsibility to write the correct values to Page Zero.

For boot (dump) IODC, ENTRY\_INIT should zero the locations IODC\_BOOT\_BASE and IODC\_BOOT\_SIZE in page zero, call PDC\_ALLOC to allocate space, then rewrite the page zero locations. This relies on the already established convention that only one device's IODC can be loaded and active at a time.

ENTRY\_IO should use the page zero locations for the appropriate device type to determine where the allocated storage for it is located. PDC\_ALLOC should not be called from within ENTRY\_IO.

The previous discussion applies only to low memory. Since a free option is provided for the high memory allocations, IODC may allocate or free memory at any time. This also allows multiple copies of IODC to be active at any time if desired for dumping to multiple dump devices.

---

The **Get AllocPtr** option (ARG1=1) is used to obtain an allocation pointer to identify separate instances of IODC which require storage. The *AllocPtr* return parameter is a 64-bit pointer. This

pointed should be used as an input argument in the **Allocate Storage** procedure call if IODC allocates storage which will subsequently have to be freed by PDC using the **Free Tagged Storage** option.

The **Free Storage** option frees the storage at the address indicated by the *Address* input argument. The *Address* should be that returned previously by the **Allocate Storage** option.

The **Free Tagged Storage** option frees all the storage tagged with the *AllocPtr* input argument. The *AllocPtr* used should be previously obtained by the **Get Allocation Ptr** option, and passed as an input parameter to the **Allocate Storage** option.

The **Free All Storage** option frees all allocated storage regardless of buffer address or tags. This option may only be used by PDC during boot prior to hand-off to the OS loader.

## PDC\_CACHE (index 5)

**Purpose:** To return the cache and TLB configuration parameters and to set the cache coherence state.

It is expected that the operating system will call PDC\_CACHE during system configuration. This enables the operating system to use the cache and TLB more efficiently.

**Options:** Option ARG1=1 must be implemented in Category B processors which issue non-coherent operations instead of coherent operations during the execution of PDCE\_CHECK and OS\_HPMC. See the PDCE\_CHECK description in Section 3.2, PDC Entry Points.

Arguments:	Description	ARG1	ARG2	ARG3	ARG4	ARG5	ARG6	ARG7
	Return parameters	0	R_addr	HV	R	R	R	R
	Set coherence state	1	R_addr	Is_cst	Ds_cst	ITs_cst	DTs_cst	R
	Return space-id bits	2	R_addr	R	R	R	R	R

**Returns:** Returns for ARG1=0:

RET[0]	RET[1]	RET[2]	RET[3]	RET[4]	RET[5]
I_size	I_conf	I_base	I_stride	I_count	I_loop
RET[6]	RET[7]	RET[8]	RET[9]	RET[10]	RET[11]
D_size	D_conf	D_base	D_stride	D_count	D_loop
RET[12]	RET[13]	RET[14]	RET[15]	RET[16]	RET[17]
IT_size	IT_conf	IT_sp_base	IT_sp_stride	IT_sp_count	IT_off_base
RET[18]	RET[19]	RET[20]			
IT_off_stride	IT_off_count	IT_loop			
RET[21]	RET[22]	RET[23]	RET[24]	RET[25]	RET[26]
DT_size	DT_conf	DT_sp_base	DT_sp_stride	DT_sp_count	DT_off_base
RET[27]	RET[28]	RET[29]			
DT_off_stride	DT_off_count	DT_loop			

Returns for ARG1=1:

RET[0]	RET[1]	RET[2]	RET[3]
Ia_cst	Da_cst	ITa_cst	DTa_cst

Returns for ARG1-2:

RET[0]
Space_bits

Status:	Value	Description
	3	Call completed with a warning. An error of unspecified type occurred, but the call completed correctly. OPTIONAL. The procedure need not report warning conditions.
	1	Error detected, partial use possible Some test failed. The returned parameters are for the usable (as opposed to the manufactured) configuration. Some coherence states not changed to requested value. CONDITIONAL. Must be used if partial use after error is possible.

0	OK The call completed normally and the procedure detected no error. REQUIRED.
-2	Nonexistent option ARG1 did not correspond to an option provided by the procedure. REQUIRED.
-3	Cannot complete call without error An error of unspecified type prevented the call from completing correctly. CONDITIONAL. Must be used if indeterminate errors can be detected.
-10	Invalid argument An argument other than ARG0 or ARG1 was invalid. OPTIONAL. The procedure need not check arguments for correctness.
-12	Assertion of BUS_POW_WARN signal detected CONDITIONAL. Must be used if the procedure cannot satisfy the powerfail budget.

**Description:** The "Return parameters" option (ARG1=0) returns 30 parameters that characterize the processor's caches and TLBs. All *\_size*, *\_base*, *\_stride*, *\_count*, and *\_loop* parameters are 64-bit unsigned integers. The returned parameters reflect the configuration determined to be usable by optional tests run during or prior to the PDC\_CACHE call.

The D-cache parameters (RET[6] - RET[11]) are not necessarily duplicates of the I-cache parameters (RET[0] - RET[5]). As well, The DTLB parameters (RET[21] - RET[29]) are not necessarily duplicates of the ITLB parameters (RET[12] - RET[20]). Software must read each set of parameters.

If a machine check causes caches or TLBs to be reconfigured, PDC\_CACHE must continue to return the same cache and TLB parameters.

#### Data Cache Parameters

*D\_size* specifies the size of the D-cache in bytes, exclusive of tags and other descriptors. It is calculated as the effective size of all the levels of the data cache and the combined cache, when the cache system is fully configured (error conditions may reduce the size of an operational cache).

If *D\_size* is 0, then there is no D-cache and *D\_conf*, *D\_base*, *D\_stride*, *D\_count*, and *D\_loop* must also be 0.

*D\_conf* specifies the configuration of the D-cache, in the following format:

R	alias	block	line	shift	wt	f-sel	cst	R	HV
0	31 32	35 36	39 40	42 43	44 45	46 47	48 50	51 61	62 63

The *alias* field specifies the aliasing boundaries for virtual addresses. The values returned are defined as follows:

Value	Description
0	Unknown <sup>1</sup>
1	4 KB
2	8 KB
3	16 KB
4	32 KB
5	64 KB

6	128KB
7	256 KB
8	512 KB
9	1 MB
10	2 MB
11	4 MB
12	8 MB
13	16 MB
14-15	Reserved

1. The aliasing boundary is unknown and may be greater than 16MB.

The *line* field specifies the maximum amount of data that will be written back to memory as the result of a store instruction, expressed as a multiple of 16 bytes. This data written to memory is aligned to an address which is a multiple of the line size. The allowed values of *line* are 0 (if no cache), 1, 2, and 4. On recent processors which support a cache line larger than 64 bytes, the *shift* field in conjunction with the *line* field, specifies the cache line size as follows: If the *line* field value is anything other than 4, the *shift* field is reserved and must contain zero. If the *line* field is 4, then the *shift* field contains an amount that the line size computed from the *line* field must be shifted left to obtain the correct line size value. The actual line size can always be computed by the expression  $(line * 16) \ll shift$ .

---

#### PROGRAMMING NOTE

Software can use the value of the D-cache line size in assigning memory addresses that can be modified by other modules. To avoid generating indeterminate data, other modules should be prevented from modifying a memory location contained in a D-cache line. It is also possible to use semaphores to control the access to memory that is shared by a processor and another module.

---

The value of *block* can be used to determine the most efficient stride for use by software to flush or purge a range of addresses. The value of *block* is 0 only if the D-cache is not implemented. The value of this stride is given by  $2^{block-1} * ((line * 16) \ll shift)$ . A flush or purge of an address will flush or purge the aligned data block of size  $2^{block-1} * ((line * 16) \ll shift)$ . (The entire data block will be ejected from the D-cache; only the lines that are dirty will be written to memory.)

---

#### PROGRAMMING NOTE

Smaller address strides can also be used in flushing or purging. In fact, the value 16 can always be assumed for the address stride for flush and purge instructions.

---

The value of *wt* is 0 if the D-cache is a write-back cache, and is 1 if the D-cache is a write-through cache.

If this bit is a 1, it means that any processor store (or semaphore) instruction is architecturally equivalent to the instruction sequence shown below. Any cache states that the cache can end up in as a result of the equivalent instruction sequence are legal.

```
store (or ldcw);
flush;
sync;
load;
```

**ENGINEERING NOTE**

For a write-back cache, it is typical to have one 'dirty' bit for each line in the D-cache. The 'dirty' bit is set if the line contains data that was stored to but not written to memory. After a store instruction writes into any part of a D-cache line (making it dirty), the entire line will be written to memory before it is replaced or removed.

**PROGRAMMING NOTE**

If a processor has a write-through D-cache, the cache contents do not need to be flushed before DMA is initiated nor during powerfail preparation, but a SYNC instruction is still necessary.

The *f\_sel* field tells software how to flush a range of addresses from the cache and has the following meaning.

Value	Description
00	Both FIC and FDC must be used
01	Only need FDC
10	Only need FIC
11	Either FIC or FDC may be used

However, if the page was accessed either as instructions only or as data only, then either a FIC loop alone (or the FICE loop), or a FDC loop alone (or the FDCE loop) may be used to flush a range of addresses (or the entire cache). In multiprocessor systems, software must look at all the *f\_sel* fields and flush in such a way (either one of the set of flushes, or both) that the address range is flushed on all the processors. The *f\_sel* fields of both *D\_conf* and *I\_conf* must be identical.

Independent of the *f\_sel* field, software has to execute both the FDCE and the FICE loops to flush either the I-cache, the D-cache, or the entire cache system. However, if an address range has been accessed either as instructions only, or as data only, then either the FICE loop, or the FDCE loop alone may be used to flush the address range.

A value of 0 in the *cst* field means that the D-cache is not issuing coherent operations; a value of 1 means that the D-cache is issuing coherent operations. Values 2 through 7 are reserved. The *cst* field must always be 0 on category A processors.

The four parameters *D\_base*, *D\_stride*, *D\_count*, and *D\_loop* are provided by PDC\_CACHE for use by software that desires to flush the entire D-cache in an efficient manner. The meaning of these four parameters will be described first from the perspective of the software that uses them and then in terms of the responsibilities of the PDC implementation that must provide them.

The four parameters have meaning only within the context of the given procedure which flushes the entire D-cache. The caller of PDC\_CACHE may not assume any other meaning.

**Perspective of the PDC\_CACHE caller**

It is always possible to flush the entire D-cache by using the FDC instruction for every physical address from 0 to the largest possible memory address (0xEEFFFFFF FFFFFFFF) and for every virtual address from 0 to the largest possible virtual address. Software can accomplish this flushing more efficiently by using the FDCE instruction, but only if it follows all the rules below:

- Software must use an equivalent of the C routine given below (where *D\_base*, *D\_count*, *D\_loop*, and *D\_stride* are the parameters returned by PDC\_CACHE).



```

unsigned int addr, count, loop, D_base, D_count, D_loop, D_stride;
addr ← D_base;
for (count ← 0; count < D_count; count++) {
    for (loop ← 0; loop < D_loop; loop++)
        FDCE(addr);
    addr ← addr + D_stride;
}

```

A routine is considered equivalent to the C routine if it generates the same sequence of FDCE instructions.

- During the execution of this loop (including trap handling), memory management instructions, loads, stores, and load and clear word instructions must not be executed.
- Software must hold the space bits constant during the execution of the entire loop, even if the addresses generated by the loop differ in the two most significant bits of the offset.
- All the FDCE instructions in the data cache flush loop must execute with the same value in the PSW D-bit.

The parameters can also be used to optimize the flushing of a range of addresses. The following programming note demonstrates this use.

---

#### PROGRAMMING NOTE

The following routine flushes the range of addresses between (space, off\_base) and (space, off\_bound):

```

unsigned int off_base, off_bound, offset;
for (offset=off_base;
    offset<=off_bound;
    offset+=pow(2,block-1)*((line*16)<<shift))
    FDC(space, offset);
FDC(space, off_bound);           /*this is required if
                                the starting address is not
                                block-aligned*/

```

This routine must execute with the PSW D-bit equal to 1 if the range to be flushed is a virtual address range, and with the D-bit equal to 0 if the range is a physical range. In a multiprocessor system where the individual processors flush different amounts of the cache on a flush, the minimum value of the product  $2^{\text{block}-1} * ((\text{line} * 16) \ll \text{shift})$  should be used in the address range cache flush loop.

Implementors are encouraged to report the product  $2^{\text{block}-1} * ((\text{line} * 16) \ll \text{shift})$  to be greater than or equal to the coherence size of the system because software that is flushing a range of addresses would perform redundant flushes (hardware is built to flush a block of the cache = coherence size upon each flush, but software is issuing flushes on a smaller granularity).

---

#### Responsibilities of the PDC\_CACHE implementation

The designers that specified how the FDCE instruction is implemented and how the D-cache is organized are responsible for identifying values of the four parameters so as to fulfill the promise to software made above.

Space register bits may be used in the hash used to index cache. Although space bits are not varied in the cache flush routine, the entire cache must still be flushed by executing the loop.

The cache flush loop must also work in the presence of coherent cache operations (coherence checks, and broadcast FIC, FDC, PDC, PDTLB, and PITLB operations).

**ENGINEERING NOTE**

This is the model of cache organization used in defining the C routine. It is included to guide cache designers in identifying values for the four parameters. This is not intended to restrict designers in any way. For example, it is allowed for a processor to flush the entire cache in response to a single FDCE instruction.

*D\_base* is used to establish the starting address. It will usually be possible to set it to 0 with no loss of generality.

*D\_stride* will usually be the size of a cache line in bytes. Thus, one would expect its value to be the *D\_conf*[line] field multiplied by 16 and shifted left by the value of the *D\_conf*[shift] field.

*D\_count* will usually be the number of lines in the cache.

*D\_loop* is intended for set-associative caches. It is used to force the FDCE instruction to be executed multiple times with the same address. Note that when *D\_loop* = 1, software can optimize out the inner loop of the C routine. So when there are multiple sets of parameters that all get the flushing job done, the one with *D\_loop* = 1 may be most efficient. Implementations that flush all elements of an associative set with a single FDCE instruction will probably use *D\_loop* = 1.

**Instruction Cache Parameters**

*I\_size* specifies the size of the I-cache in bytes, exclusive of tags and other descriptors. It is calculated as the effective size of all the levels of the instruction cache and the combined cache, when the cache system is fully configured (error conditions may reduce the size of an operational cache).

If *I\_size* is 0, then there is no I-cache and *I\_conf*, *I\_base*, *I\_stride*, *I\_count*, and *I\_loop* must also be 0.

*I\_conf* specifies the configuration of the I-cache, in the following format:

R	alias	block	line	shift	R	f-sel	cst	R	HV
0	31 32	35 36	39 40	42 43	44 45	46 47	48 50	51 61	62 63

The value of *line* has no meaning by itself, because instructions cannot become dirty and be written back to memory. The most efficient stride for flushing a range of addresses from the I-cache is given by  $2^{\text{block}-1} * ((\text{line} * 16) \ll \text{shift})$ . The value of *block* is 0 only if the I-cache is not implemented. The *f-sel* field of *I\_conf* must be identical to that of *D\_conf* word. The *alias* field of *I\_conf* returns the offset aliasing boundary for virtual addresses as explained in the *D\_conf* description, but may have a different value if the instructions and data caches do not have the same aliasing boundary.

A value of 0 in the *cst* field means that the I-cache is not issuing coherent operations; a value of 1 means that the I-cache is issuing coherent operations. Values 2 through 7 are reserved.

The four parameters *I\_base*, *I\_stride*, *I\_count*, and *I\_loop* are provided by PDC\_CACHE for use by software that desires to flush the entire I-cache in an efficient manner. The four parameters have meaning only within the context of the given procedure which flushes the entire I-cache. The caller of PDC\_CACHE may not assume any other meaning.

The four parameters *I\_base*, *I\_stride*, *I\_count*, and *I\_loop* are used in a procedure which is guaranteed to flush the entire I-cache. Software can accomplish this flushing by using the FICE instruction, but only if it follows the rules below:

- Software must use an equivalent of the C routine given below (where *I\_base*, *I\_count*, *I\_loop*, and *I\_stride* are the parameters returned by PDC\_CACHE).

```

unsigned int addr, count, loop, I_base, I_count, I_loop, I_stride;
addr ← I_base;
for (count ← 0; count < I_count; count++) {
    for (loop ← 0; loop < I_loop; loop++)
        FICE(addr);
    addr ← addr + I_stride;
}
    
```

A routine is considered equivalent to the C routine if it generates the same sequence of FICE instructions.

- Software need not insure that there are no extraneous interactions with the I-cache while the routine is being executed. It would not be possible to meet such a condition, because the code is executing out of the I-cache. During the execution of this loop (including trap handling), memory management instructions must not be executed.
- Software must hold the space bits constant during the execution of the entire loop, even if the addresses generated by the loop cross quadrant boundaries.
- All the FICE instructions in the loop must execute with the same value in the PSW D- and C-bits.

Space register bits may be used in the hash used to index cache. Although there is no variation of space in the cache flush routine, the entire cache must still be flushed by executing the loop.

The cache flush loop must also work in the presence of coherent cache operations (coherence checks, and broadcast FIC, FDC, PDC, PDTLB, and PITLB operations).

**Instruction TLB Parameters**

*IT\_size* specifies the maximum number of entries in the instruction TLB which is calculated as the effective size of all the levels of the ITLB and combined TLBs in a fully configured situation (no entries have been locked out, or deconfigured).

If *IT\_size* is 0, then there is no instruction TLB and *IT\_conf*, *IT\_sp\_base*, *IT\_sp\_stride*, *IT\_sp\_count*, *IT\_off\_base*, *IT\_off\_stride*, *IT\_off\_count*, and *IT\_loop* must also be 0.

*IT\_conf* specifies the configuration of the instruction TLB, as follows:

R	p-sel	HV	page	cst	aid	sr	HV
0	43 44	45 46	47 48	50 51	55 56	61 62	63

The *p-sel* field tells software how to purge the TLBs and has the following meaning:

Value	Description
00	Both PITLB and PDTLB must be used
01	Only need PDTLB
10	Only need PITLB
11	Either PITLB or PDTLB may be used

In multiprocessor systems, software must look at all the *p-sel* fields and purge in such a way (either one of the set of purges, or both) that the translations are purged on all the processors.

The architectural page size is 4 Kbytes. Some machines, however, implemented 2 Kbyte pages. The *page* field can be used to identify 2 Kbyte page machines. *page* is normally 1, but is 0 for machines with 2 Kbyte pages.

---

**PROGRAMMING NOTE**

Software should be aware that some PA-RISC systems have a 2-Kbyte page size and a 2-Kbyte alignment restriction.

---

A value of 0 in the *cst* field means that the ITLB is not issuing coherent operations; a value of 1 means that the TLB is issuing coherent operations. Values 2 through 7 are reserved.

The width of the access ids of the processor is encoded in the *aid* field. The width is  $15 + aid$ . The width of the space registers is encoded in the *sr* field. If the processor is Level 2, the *sr* field specifies the number of additional spare register bits beyond 32 which are available. The *sr* field is reserved for non Level 2 processors, and the width of the space registers is determined directly by the Level (0, 16, or 24 for Level 0, Level 1, or Level 1.5, respectively)

The seven parameters *IT\_sp\_base*, *IT\_sp\_stride*, *IT\_sp\_count*, *IT\_off\_base*, *IT\_off\_stride*, *IT\_off\_count*, and *IT\_loop* are used in a procedure which is guaranteed to purge the entire instruction TLB. The parameters make the purging procedure work but have no other meaning. The procedure must be run in an environment in which no extraneous TLB interactions can occur (which can be assured if the routine runs with the PSW C- and D-bits=0 and with external interrupts masked). The following C routine (using the values returned by PDC\_CACHE) is guaranteed to purge the entire instruction TLB:

```

unsigned int space, sp_count, IT_sp_base, IT_sp_stride, IT_sp_count,
            offset, off_count, IT_off_base, IT_off_stride, IT_off_count,
            loop, IT_loop;
space ← IT_sp_base;
for (sp_count ← 0; sp_count < IT_sp_count; sp_count++) {
    offset ← IT_off_base;
    for (off_count ← 0; off_count < IT_off_count; off_count++) {
        for (loop ← 0; loop < IT_loop; loop++)
            PITLBE(space, offset);
        offset ← offset + IT_off_stride;
    }
    space ← space + IT_sp_stride;
}

```

---

**ENGINEERING NOTE**

This is the model of TLB organization used in defining the C routine. It is included to guide TLB designers in identifying values for the seven parameters. The model assumes that a TLB entry is accessed by hashing together portions of the space and offset of the address. The two outer loops are used to generate the combinations of spaces and offsets that amongst them hash to every entry in the TLB.

*IT\_sp\_base* is used to establish the starting space. It will usually be possible to set it to 0 with no loss of generality.

*IT\_sp\_stride* is the increment to the space part of the address. If the hashing function does not use the  $N$  least significant bits of the space, then *IT\_sp\_stride* would be  $2^N$ . This rule of thumb remains valid even if the hashing function does use the least significant bits of the space ( $N = 0$  implies *IT\_sp\_stride* = 1).

*IT\_sp\_count* is the number of space values that must be generated. If the hashing function uses  $M$  contiguous bits in the space, then *IT\_sp\_count* need not be greater than  $2^M$ . This rule of thumb remains valid even if the hashing function does not use the space at all ( $M = 0$  implies *IT\_sp\_count* = 1).

*IT\_off\_base* is used to establish the starting offset. It will usually be possible to set it to 0 with no loss of generality.

*IT\_off\_stride* is the increment to the offset part of the address. If the hashing function does not use the P least significant bits of the offset, then *IT\_off\_stride* would be  $2^P$ .

*IT\_off\_count* is the number of offset values that must be generated. If the hashing function uses Q contiguous bits in the offset, *IT\_off\_count* need not exceed  $2^Q$ .

*IT\_loop* is intended for set-associative TLBs. It is used to force the PITLBE instruction to be executed multiple times with the same address. Note that, when *IT\_loop* = 1, software can optimize out the innermost loop of the C routine. So when there are multiple sets of parameters that all get the purging job done, the one with *IT\_loop* = 1 may be most efficient.

---

### Data TLB Parameters

*DT\_size* specifies the maximum number of entries in the data TLB which is calculated as the effective size of all the levels of the DTLB and combined TLBs in a fully configured situation (no entries have been locked out or deconfigured).

If *DT\_size* is 0, then there is no data TLB and *DT\_conf*, *DT\_sp\_base*, *DT\_sp\_stride*, *DT\_sp\_count*, *DT\_off\_base*, *DT\_off\_stride*, *DT\_off\_count*, and *DT\_loop* must also be 0.

*DT\_conf* specifies the configuration of the data TLB, as follows:

R	p-sel	HV	u	cst	R	HV
0	43 44	45 46	47 48	50 51	61 62	63

The meanings of the fields within *DT\_conf* are analogous to the corresponding fields of *IT\_conf* except for bit 15, which is the *u* field instead of the *page* field, and bits 19-29 which are Reserved. A 1 in the *u* field indicates that the processor implements the TLB u-bit, and a 0 indicates that it does not.

The seven parameters *DT\_sp\_base*, *DT\_sp\_stride*, *DT\_sp\_count*, *DT\_off\_base*, *DT\_off\_stride*, *DT\_off\_count*, and *DT\_loop* can be used to purge the entire data TLB. The C routine which purges the entire data TLB is analogous to the one given to purge the entire instruction TLB.

The "**Set coherence state**" option (ARG1=1) attempts to set the current coherence state in the I- and D-caches and TLBs. The following is the format for *Is\_cst*, *Ds\_cst*, *ITs\_cst*, and *DTs\_cst*:

R	cst	R
0	47 48	50 51
		63

The *cst* field is the coherence state desired for the I-cache, D-cache, ITLB, and DTLB. A value of 0 in the *cst* field means that the cache/TLB do not issue coherent operations; a value of 1 means that the cache/TLB do issue coherent operations. Values 2 through 7 are reserved.

Return parameters *Ia\_cst*, *Da\_cst*, *ITa\_cst*, and *DTa\_cst* indicate the actual coherence state. The following is the format for *Ia\_cst*, *Da\_cst*, *ITa\_cst*, and *DTa\_cst*:

R	cst	R
0	47 48	50 51
		63

If a return value differs from its corresponding argument, then the processor is unable to change to the desired state, and the return value is the current, unchanged state.

The "**Return space-ID bits**" option (ARG1=2) returns whether space-ID hashing is turned on, and which bits are used in the hashing algorithm. If space-ID hashing is not turned on, a 0 will be returned in the *Space\_bits* parameter. If space-ID hashing is turned on, the return will be non-zero, and will be formatted as follows:

**PDC\_CACHE (index 5)**

(continued)

R	R	Bits_Used	R
0	31 32	35 36	47 48
			63

## PDC\_CHASSIS (index 2)

**Purpose:** To update the chassis display and return chassis warnings.

Arguments:	Description	ARG1	ARG2	ARG3
	Update chassis display	0	data	HV
	Return chassis warnings	1	R_addr	HV
	Update display and return warnings	2	R_addr	data

Returns:	Description	RET[0]
	Update chassis display	---
	Return chassis warnings	warn
	Update display and return warnings	warn

Status:	Value	Description
	3	Call completed with a warning. An error of unspecified type occurred, but the call completed correctly. OPTIONAL. The procedure need not report warning conditions.
	0	OK The call completed normally and the procedure detected no error. REQUIRED.
	-2	Nonexistent option ARG1 did not correspond to an option provided by the procedure. REQUIRED.
	-3	Cannot complete call without error An error of unspecified type prevented the call from completing correctly. CONDITIONAL. Must be used if indeterminate errors can be detected.
	-10	Invalid argument An argument other than ARG0 or ARG1 was invalid. OPTIONAL. The procedure need not check arguments for correctness.

**Description:** Any processor may execute PDC\_CHASSIS to update the chassis display or read the chassis warnings.

The actual number of chassis displays and chassis warnings that must be implemented, and which processors must execute PDC\_CHASSIS at what frequencies is defined by the *Chassis I/O Standard*.

The number of chassis displays, and the mechanism by which they are shared in a multiprocessor system is defined by the *Chassis I/O Standard*.

The procedure is best suited to a display with four hex digits, but the display codes are designed to present the maximum error information for each of the display options.

The "**Update chassis display**" option (ARG1=0) displays new data and system state on the chassis display.

The "**Return chassis warnings**" option (ARG1=1) returns warnings pertaining to the fans, batteries, and temperature.

The "**Update display and return warnings**" option (ARG1=2) updates the display and returns the warnings.

The *data* argument specifies the contents of the display, as follows:

R	sysstat	blank	D0	D1	D2	D3
0	43 44	46 47	48 51 52	55 56	59 60	63

The *sysstat* field identifies which of the eight states the system is currently in. The states are defined as follows:

<i>sysstat</i>	System State
000	Off
001	Fault
010	Test
011	Initialize
100	Shutdown
101	Warning
110	Run
111	All On

The values of D0, D1, D2, and D3 are the 4-bit numbers representing the four hex digits on the display. The value generated on the display is the hex representation of these digits, the leftmost digit is D0 and the rightmost is D3.

If the *blank* bit is set, the display should be made blank, if possible, regardless of the values of D0, D1, D2, and D3.

The return parameter *warn* has the following format:

R	r_power	R	b_low	t_low	t_mid
0	31 32	39 40	60 61	62	63

When *r\_power* is 0, there is no failure of any redundant chassis component (such as a fan or power supply). A nonzero value of *r\_power* identifies a failed redundant chassis component; the encoding of the nonzero values is HVERSION dependent.

The value of *b\_low* = 0 implies that the battery is good (or that this feature is not provided). The value of *b\_low* = 1 implies that the battery is low, so memory may not be preserved during a power failure.

The value of *t\_low* = 1 if the product temperature has exceeded the Temp\_Low threshold.

The value of *t\_mid* = 1 if the product temperature has exceeded the Temp\_Mid threshold.

Processors which do not provide warning detection must return 0 for *warn*.



## PDC\_CONFIG (index 17)

**Purpose:** To request deconfiguration and reconfiguration of modules, and to obtain configuration status information.

**Options:** The implementation of options ARG1=0 and ARG1=1 as a pair is optional. However, if either one is implemented, the other must be implemented as well. Option ARG1=2 is required.

Arguments:	Description	ARG1	ARG2	ARG3	ARG4	ARG5	ARG6	ARG7
	Deconfig module	0	R_addr hpa	R	R	R	R	R
	Reconfig module	1	R_addr hpa	R	R	R	R	R
	Return config info	2	R_addr hpa	R	R	R	R	R

Returns:	Description	RET[0]
	Deconfig module	R
	Reconfig module	R
	Return config info	config_info

Status:	Value	Description
	3	Call completed with a warning. An error of unspecified type occurred, but the call completed correctly. OPTIONAL. The procedure need not report warning conditions.
	1	Multiple deconfiguration attempts The requested deconfiguration has already been performed, or an earlier request for deconfiguration was accepted. Returned only by option ARG1=0. REQUIRED.
	0	OK The call completed normally and the procedure detected no error. REQUIRED.
	-2	Nonexistent option ARG1 did not correspond to an option provided by the procedure. REQUIRED.
	-3	Cannot complete call without error An error of unspecified type prevented the call from completing correctly. CONDITIONAL. Must be used if indeterminate errors can be detected.
	-4	Absent module There is no module present at the specified hpa. REQUIRED.
	-5	Last processor/Insufficient memory The request for deconfiguration was denied because the module for deconfiguration is the last of its type or the remaining amount of memory would have been less than 256 Kbytes. Returned only by option ARG1=0. REQUIRED.
	-6	Cannot provide functionality The requested functionality cannot be provided for the specified hpa. REQUIRED. Applicable only for options ARG1=0 or ARG1=1.
	-10	Invalid argument An argument other than ARG0 or ARG1 was invalid. OPTIONAL. The procedure need not check arguments for correctness.
	-12	Assertion of BUS_POW_WARN signal detected CONDITIONAL. Must be used if the procedure cannot satisfy the powerfail budget.

**Description:** The PDC\_CONFIG procedure is used to request deconfiguration and reconfiguration of modules on the central bus. This procedure is also used to obtain the configuration status of modules on the central bus.

The deconfiguration or reconfiguration is performed at the next hard boot. Module deconfiguration and reconfiguration must not be performed during soft boot.

PDC must maintain the module configuration status uniquely across the system as tertiary state, and preserve this information across PDCE\_RESET and PDCE\_TOC.

---

#### SUPPORT NOTE

If deconfiguration and reconfiguration is considered to be absolutely necessary, a soft boot may be followed by a hard boot (after a dump) to perform deconfiguration and reconfiguration.

---

The "**Deconfig module**" option (ARG1=0) is used to request the deconfiguration of a faulty module on the central bus. PDC must deconfigure the module corresponding to the *hpa* argument at the time of the next hard boot. This call overrides any previous "Reconfig module" option call to the same *hpa*.

The last processor and memory modules in the system must not be deconfigured. PDC must deny a request to deconfigure the last processor or memory module, and must return a status of -5. Additionally, to improve availability, PDC must ensure that the system has at least 256 Kbytes after deconfiguration.

This call must have no effect on the target module's state. However, the actual deconfiguration during the next hard boot may change the register set state. A deconfigured module may optionally choose not to assert PATH\_SLAVE\_ACK to all transactions. In such a case, the module must return a status of -4 for the PDC\_IODC "Get entry point" option. Also, PDC\_ADD\_VALID must return a status of 1 or 2 in this case. Alternatively, if the module asserts PATH\_SLAVE\_ACK to any transaction, it must allow the PDC\_IODC "Get entry point" option to complete normally.

---

#### PROGRAMMING NOTE

Since PDC\_IODC may not return status -4 for a deconfigured module, PDC\_CONFIG (ARG1 = 2) should also be called to determine the system configuration.

---

If this call is issued to any memory module belonging to an interleaved group, the entire interleaved group must be deconfigured.

A deconfigured module must not request bus operations. Further, deconfigured processors must not participate in cache coherence protocols or monarch selection.

---

#### SUPPORT NOTE

It is suggested that the operating system inform the user through the system console that deconfiguration will take place at the next hard boot, after a deconfiguration request has been accepted.

---

The "**Reconfig module**" option (ARG1=1) is used to request the reconfiguration of a module on the central bus specified by the *hpa* argument. The *hpa* argument for this call must represent the *hpa* that the module would respond to when it is configured. This call overrides any previous "Deconfig module" option call to the same *hpa*.

If this call is issued to any memory module belonging to an interleaved group, the entire interleaved group must be reconfigured.

The "**Return config info**" option (ARG1=2) is used to obtain the configuration status of the modules on the central bus. The legal values for *config\_info* are as follows:

<i>config_info</i>	Configuration Status
0	Module configured and not slated to be deconfigured
1	Module deconfigured and not slated to be reconfigured
2	Module configured, but slated to be deconfigured
3	Module deconfigured, but slated to be reconfigured

The *hpa* argument for this call must represent the hpa that the module would respond to when it is configured or the hpa if configured.

## PDC\_COPROC (index 7)

**Purpose:** To identify the coprocessors attached to the processor.

Arguments:	Description	ARG1	ARG2
	Return coprocessor configuration	0	R_addr

Returns:	Description	RET[0]	RET[1]
	Return coprocessor configuration	ccr_functional	ccr_present

Status:	Value	Description
	3	Call completed with a warning. An error of unspecified type occurred, but the call completed correctly. OPTIONAL. The procedure need not report warning conditions.
	1	Error detected, partial use possible This status must be returned if <i>ccr_functional</i> does not equal <i>ccr_present</i> . CONDITIONAL. Must be used if coprocessors are tested during the call.
	0	OK The call completed normally and the procedure detected no error. REQUIRED.
	-2	Nonexistent option ARG1 did not correspond to an option provided by the procedure. REQUIRED.
	-3	Cannot complete call without error An error of unspecified type prevented the call from completing correctly. CONDITIONAL. Must be used if indeterminate errors can be detected.
	-10	Invalid argument An argument other than ARG0 or ARG1 was invalid. OPTIONAL. The procedure need not check arguments for correctness.
	-12	Assertion of BUS_POW_WARN signal detected CONDITIONAL. Must be used if the procedure cannot satisfy the powerfail budget.

**Description:** The "**Return coprocessor configuration**" option (ARG1=0) returns parameters which describe the presence and status of the coprocessors attached to the processor. Following PDC\_COPROC, the state of all coprocessors is HVERSION dependent.

---

### ENGINEERING NOTE

The coprocessors may be optionally tested during the call. It is recommended that the test be limited to a simple GO/NO GO test.

---

*ccr\_functional* specifies which coprocessors are present and functional. A set bit indicates that the corresponding coprocessor is both present and, if tested, has passed the test. The format of *ccr\_functional* is the same as the CCR (CR10). If *ccr\_functional* is moved into the CCR, each present and functional coprocessor is enabled.

*ccr\_present* specifies which coprocessors are present. A set bit indicates that the corresponding coprocessor is present. If the bit is set in *ccr\_present* and cleared in *ccr\_functional*, the coprocessor is present but has failed a functional test. The format of *ccr\_present* is the same as the CCR (CR10).

The operating system must call PDC\_COPROC during boot and powerfail recovery to determine which coprocessors are present and functional. A state restore sequence of a valid coprocessor state must be used after the PDC\_COPROC call to enable use by the OS.

If the coprocessors require initialization upon power on, and PDCE\_RESET does not perform that initialization, then the coprocessors must be initialized by PDC\_COPROC.

## PDC\_CRASH\_PREP (index 25)

**Purpose:** To quiece I/O and perform whatever platform specific activities are necessary to perform a dump, including initialization of the dump device. Also to ensure that adequate platform information is available in the dump.

Arguments:	Description	ARG1	ARG2	ARG3	ARG4
	Prepare for Dump	0	R_addr	memaddr	R
	Log CEC Errors	1	R	R	R

Returns:	Description	RET[i]
	Prepare for Dump	dump_path[i]
	Log CEC Errors	0

Status:	Value	Description
	1	Not all dump devices could be mapped. Any dump devices which could not be mapped will return a value of 0xFFFFFFFF for dump_path[i]. REQUIRED.
	0	OK The call completed normally and the procedure detected no error. REQUIRED.
	-2	Nonexistent option ARG1 did not correspond to an option provided by the procedure. REQUIRED.
	-3	Cannot complete call without error An error of unspecified type prevented the call from completing correctly. CONDITIONAL. Must be used if indeterminate errors can be detected.
	-5	No dump devices could be mapped. None of the dump devices specified could be mapped. REQUIRED.
	-10	Invalid argument An argument other than ARG0 or ARG1 was invalid. OPTIONAL. The procedure need not check arguments for correctness.
	-12	Assertion of BUS_POW_WARN signal detected CONDITIONAL. Must be used if the procedure cannot satisfy the powerfail budget.

**Description:** The "**Prepare for Dump**" option (ARG1=0) is used to perform platform specific preparations for taking a dump. All I/O must be quiesced, and the I/O and device path must be opened to all dump devices which are requested. The dump device must be initialized, including loading all BAR registers for PCI devices. It is not necessary to load either dump or console IODC for OS use. FIRMWARE may load Console IODC for its own use and may issue messages to the console, but OS software should not assume that any IODC has been loaded. The OS may not be returned to a running state, but must be rebooted after taking a dump when using this procedure option.

In addition to the procedure option number itself, there are two input arguments. Arg0, *R\_addr* is a pointer to a memory area provided by the caller which provides space for 32 64-bit return values. Arg1, *memaddr* is a pointer to a memory area provided by the caller which holds an input data structure that describes the dump devices the caller requests PDC to initialize and provide a path to.

The memory structure pointed to by *memaddr* must be at least 1056 bytes in length and follows the format in the following table:

Offset	Size	Type	Value
0x00	4	Char[4]	"DUMP"
0x04	4	Uint32	Number of dump devices (max 32)
0x08	0x18	Reserved	
0x20	0x20	Device path 0 with layers structure	
0x40	0x20	Device path 1 with layers structure	
	...		
0x400	0x20	Device path 31 with layers structure	
0x420		End of buffer	

This procedure option quiesces the entire I/O system, opens the hardware I/O path to each dump device in the *memaddr* data structure, and initializes each device, including programming PCI BAR registers. IODC is not loaded. For each device, *i*, for which the operation was successful, PDC\_CRASH\_PREP returns in RET[*i*] the device path to that device without the layers structure. If the operation is not successful, then a -1 is returned in RET[*i*].

The "Log CEC Errors" option (ARG1=1) is used to log any errors in the hardware registers for the following CEC components: memory controllers, SBAs, LBAs, or fabric chips. When necessary, components will be quiesced and taken out of fatal error mode to log components behind them. The system must not be returned to a running state, but must be rebooted after taking a dump when this procedure option is used.

---

**PROGRAMMING NOTE**

The following paragraphs describe the appropriate use of PDC\_CRASH\_PREP in the various programming paths that lead to taking a dump.

**Requirements**

PDC\_CRASH\_PREP is intended to be a replacement for, and to supplement the operation of the Hversion PDC call PDC\_IO. The purpose of this programming note is to describe how the OS can write code that works on all platforms (older ones with neither PDC\_CRASH\_PREP or PDC\_IO, platforms with PDC\_IO, and newer platforms with PDC\_CRASH\_PREP).

PDC\_CRASH\_PREP is also designed to handle a new condition that is come about due to the PCI definition. In the past, if any CEC went into fatal error mode, it was guaranteed that the OS would see an HPMC as a result. With the -1 data returns for PDC, it is now possible for an LBA or SBA to go into fatal error mode, and the OS to NOT see an HPMC as a result. It may happen that the OS panics instead. In these cases, we still want to log the CEC error registers. This will require a PDC\_CRASH\_PREP call in the OS Panic path.

Since PDC\_CRASH\_PREP must necessarily change system state, it should be used ONLY in the dump path, and the system should not be returned to an operational state after the use of PDC\_CRASH\_PREP. In particular, it may not be used by diagnostic software on a running system.

Finally, after PDC\_CRASH\_PREP or PDC\_IO has logged CEC errors, a method must be provided to read the error logs. In systems which use PDC\_IO, PDC\_PIM has been extended to return CEC error logs after the PIM information. This works for HPMCs and TOCs. However, CEC error information may be available in some cases where PIM information is not required (OS Panic and GSM Recovery). For this reason, an additional call, PDC\_SYSTEM\_INFO[Return Errors] is defined to read CEC error logs when PIM information is not required.

**Operation:**

There are two options for PDC\_CRASH\_PREP. Option 0, Prepare for Dump, ensures that there is a path to the dump device and the dump device is ready to receive the dump. It also turns off ECC and virtual index checking of memory contents to prevent an HPMC during the dumping of memory. Option 1, Log CEC Errors, logs the error and status registers in the CEC, including memory, I/O, and fabric. It may have to take I/O or fabric components out of FE mode to log registers.

Option 1 should be called only in the OS panic path, since these registers can be logged by firmware in the TOC and HPMC paths. Option 0 should only be called in the dump path, after all other preparations for dump have been completed. The following shows typical pseudocode for the use of PDC\_CRASH\_PREP. This is not intended to be a complete description of these code paths, but to simply show where PDC\_CRASH\_PREP fits in. Before describing the pseudocode, I will talk about the paths which are potentially affected, and describe which one should use PDC\_CRASH\_PREP and which ones should not.

There are (will be) four independent code paths of interest on our new systems, HPMC, TOC, OS Panic, and GSM Recovery. The dump path is a dependent path which is called by the first three. HPMC, TOC, and OS Panic all currently exist and call the dump procedure. The GSM recovery path is new, and will NOT call the dump procedure. The GSM recovery path should NOT call PDC\_CRASH\_PREP.

The following outlines what is done on each path.

GSM recovery:

Firmware will log CEC errors during the recovery phase.

The OS may call PDC\_SYSTEM\_INFO[Return Errors] to read logged CEC errors.

HPMC:

There is no need to change the HPMC path. Firmware will log any CEC errors during PDCE\_CHECK. If firmware has to take any CEC out of FE mode, it will mark the HPMC as unrecoverable. The OS will obtain the CEC error logs when it calls PDC\_PIM. On older machines the HPMC path will continue to operate the same as it does today. If PCI -1 returns are to be supported on machines with PDC\_IO, then the input parameter to PDC\_IO option 0 to log CEC errors should be added \*OR\* the firmware should be upgraded to log CEC errors.

TOC:

There is no change to the TOC path.

OS Panic Path: (pseudocode)

```
(After rendezvousing processors, flushing cache, and switching to
real mode):
/* Start new code */
Call PDC_CRASH_PREP[Log CEC ERRORS];
If (Return_Status == Invalid_Procedure_Option) Call PDC_IO[0] with parameter
to log I/O. /* this indicates an older machine without PDC_CRASH_PREP */
If (Return_Status == Call_completed_successfully)
/* At this point, CEC errors have been successfully logged, either by
PDC_CRASH_PREP or PDC_IO */
Call PDC_SYSTEM_INFO[Return Errors]
/* End new code */
Call dump procedure;
Call PDC_BROADCAST_RESET; /* required to avoid data corruption */
```

## Dump procedure path:

```
Init Console and Write console message;  
/* Start new/changed code */  
Call PDC_CRASH_PREP[Prepare for Dump]  
If (Return_Status == Invalid_Procedure_Option) Call PDC_IO[2];  
/* This was previously just Call PDC_IO[2] */  
/* End new/changed code */  
If (Return_Status <> Call_completed_successfully)  
    Check each device for "not mapped" status;  
Write dump to available devices;  
Return;
```

---



## PDC\_HPA (index 6)

**Purpose:** To return the hard physical address of the processor and to indicate which modules on the bus exist on the same board as the processor.

**Options:** Option ARG1=1 is required for processors on a bus which implements On Line Replacement (OLR). Option ARG1=1 is HVERSION dependent for other processors.

Arguments:	Description	ARG1	ARG2	ARG3	ARG4	ARG5	ARG6	ARG7
	Return processor HPA	0	R_addr	HV	---	---	---	---
	Return modules	1	R_addr	R	R	R	R	R

Returns:	Description	RET[0]	RET[1]
	Return processor HPA	hpa	cpu_num
	Return modules	mods_0	mods_1

Status:	Value	Description
	3	Call completed with a warning. An error of unspecified type occurred, but the call completed correctly. OPTIONAL. The procedure need not report warning conditions.
	0	OK The call completed normally and the procedure detected no error. REQUIRED.
	-2	Nonexistent option ARG1 did not correspond to an option provided by the procedure. REQUIRED.
	-3	Cannot complete call without error An error of unspecified type prevented the call from completing correctly. CONDITIONAL. Must be used if indeterminate errors can be detected.
	-10	Invalid argument An argument other than ARG0 or ARG1 was invalid. OPTIONAL. The procedure need not check arguments for correctness.
	-12	Assertion of BUS_POW_WARN signal detected CONDITIONAL. Must be used if the procedure cannot satisfy the powerfail budget.

**Description:** The "**Return processor HPA**" option (ARG1=0) returns the hard physical address of the processor.

The return parameter *hpa* contains the processor's HPA, in the following format:

1111	flex	fixed	R
0	3 4	45 46	51 52
			63

The *cpu\_num* return parameter is an optional return parameter containing a unique identifying number for that processor. *cpu\_num* is a 64-bit unsigned integer. If no unique identifying number is returned, the return parameter must be 0.

The "**Return modules**" option (ARG1=1) returns two 32-bit bitmasks indicating which modules on the bus exist on the same board as the processor. A set bit indicates that the module is on the same board while a clear bit indicates it is not. Bits 32-63 in *mods\_0* correspond to modules 0-31. Bits 32-63 in *mods\_1* correspond to modules 32-63. (Bits 0-31 are Reserved in both return parameters.) If this option is not implemented, software must assume that all modules on the bus are implemented on the processor board.

## PDC\_IODC (index 8)

**Purpose:** To obtain the I/O-dependent code for a module and to emulate architected functionality in processor-dependent memory modules.

**Options:** Options ARG1=2 and ARG1=4 are defined for use with processor-dependent memory modules. Processors that do not support processor-dependent memory do not provide these options. Option ARG1=5 is defined for use with interleaved processor-dependent memory. Processors that do not support interleaved memory do not provide this option.

Arguments:	Description	ARG1	ARG2	ARG3	ARG4	ARG5	ARG6
	Get entry point	0	R_addr	hpa	index	memaddr	count
	Nondestructive init	2	R_addr	hpa	spa	---	---
	Return and clear errors	4	R_addr	hpa	spa	---	---
	Identify primary	5	R_addr	hpa	---	---	---

Returns:	Description	RET[0]	RET[1]	RET[2]	RET[3]
	Get entry point	actcnt	R	R	R
	Nondestructive init	stat	max_spa	max_mem	R
	Return and clear errors	stat	resp	info	req
	Identify primary	primary_hpa	R	R	R

Status:	Value	Description
	3	Call completed with a warning. An error of unspecified type occurred, but the call completed correctly. OPTIONAL. The procedure need not report warning conditions.
	2	Unrecoverable memory module error (some memory usable) A memory error was detected during initialization but some memory is still usable. Returned only by option ARG1=2. CONDITIONAL. Must be used if memory is partially configurable after an error.
	1	Recoverable memory module error The call completed normally and the returned results are valid. The procedure encountered an error which it was able to correct completely. Returned only by option ARG1=2. CONDITIONAL. Must be used if the implementation performs error recovery.
	0	OK The call completed normally and the procedure detected no error. REQUIRED.
	-2	Nonexistent option ARG1 did not correspond to an option provided by the procedure. REQUIRED.
	-3	Cannot complete call without error An error of unspecified type prevented the call from completing correctly. CONDITIONAL. Must be used if indeterminate errors can be detected.
	-4	Operation completed with requestor bus error The processor detected a requestor bus error during the READ operation to the IO_DC_DATA register of the target HPA (ARG3). The caller may assume that no IODC exists at the target HPA. REQUIRED. Returned only by option ARG1 = 0.
	-5	Valid IODC for this module, but invalid index specified in ARG4 REQUIRED. Returned only by option ARG1=0.
	-6	Requested IODC exceeds <i>count</i> bytes REQUIRED. Returned only by option ARG1=0.

- 10 Invalid argument  
An argument other than ARG0 or ARG1 was invalid.  
OPTIONAL. The procedure need not check arguments for correctness.
- 12 Assertion of BUS\_POW\_WARN signal detected  
CONDITIONAL. Must be used if the procedure cannot satisfy the powerfail budget.
- 18 IODC checksum error  
REQUIRED. Returned only by option ARG1=0.
- 19 Satellite not associated with any primary  
The target HPA (ARG3) is a satellite which is not configured to be part of any interleave group and thus is not associated with any primary. For example, a faulty satellite might not be configured.  
REQUIRED. Returned only by option ARG1=5.

**Description:** The "Get entry point" option (ARG1=0) provides access to the IODC of the module specified by the *hpa* argument. Software is required to use the option for all IODC access, rather than read the IODC directly. The caller allocates a buffer in memory into which the option deposits the requested IODC. The buffer is at memory location *memaddr* and is *count* bytes in length. The value of *memaddr* must be doubleword aligned; *count* is an unsigned 64-bit integer and must be a multiple of eight. The entry point to get is selected by *index*, which is an unsigned integer in the range [0..255]. The return parameter *actcnt* is the actual number of bytes in the entry point selected. *actcnt* is an unsigned 64-bit integer and must be a multiple of eight.

The IODC data bytes are returned in the following format in the *memaddr* buffer:

<i>memaddr</i>	byte 0	byte 1	byte 2	byte 3
	byte actcnt-4	byte actcnt-3	byte actcnt-2	byte actcnt-1

The "Get entry point" option treats *index*=0 as a special case. First, *index*=0 does not return IODC entry point 0, but instead returns the first 16 bytes of the module's IODC. Second, RET[0] is HVERSION dependent because modules can provide three different subsets of the first 16 IODC bytes. It is the responsibility of the caller to determine from byte 3 of the *memaddr* buffer (it is the IODC\_TYPE byte) which (if any) of the other bytes are valid. The caller must provide 16 bytes of storage, beginning at *memaddr*. The argument *count* is HVERSION dependent.

The existence of a module at the target HPA (ARG3) must be verified by PDC\_IODC before any transfer of data is attempted. The caller is not required to have called PDC\_ADD\_VALID before calling PDC\_IODC. PDC\_IODC must return status value -4 if it detects a requestor bus error while reading the IO\_DC\_DATA register of the target HPA. It must also return status value -4 when deconfigured if it does not normally assert PATH\_SLAVE\_ACK in this state.

When verifying the HPA of the target module, PDC\_IODC must conform to the requirements set forth for PDC\_ADD\_VALID. These requirements include the detection of other HPMC conditions besides requestor bus errors, and the clearing of the soft errors in the bus converters on the path to the target HPA. (See the Description section in the PDC\_ADD\_VALID page).

If a processor has a data or instruction cache, PDC\_IODC must flush the entries in the data or instruction cache that correspond to the memory buffer allocated by the caller.

The following PDC\_IODC algorithm validates the existence of a module, and accesses a location (the type field) in the IODC. Any IODC access algorithms should begin in this manner.

1. Read the module's IO\_DC\_DATA register. If a bus error results, the module is presumed not to exist and the sequence is terminated.
2. Write the value 3 to IO\_DC\_ADDRESS to address the module type specifier (the IODC\_TYPE byte).
3. Read IO\_DC\_DATA to obtain the IODC\_TYPE byte.

---

#### ENGINEERING NOTE

The PDC\_IODC procedure allows fixed configurations to use the processor's PDC to emulate a module's IODC. In particular, for native processors without the IO\_DC\_ADDRESS and IO\_DC\_DATA registers, the PDC\_IODC procedure must be able to identify the processor and return 0 for its IODC\_TYPE byte.

---



---

#### PROGRAMMING NOTE

It is possible that a module that is deconfigured, even if physically present, returns a status of -4 to the PDC\_IODC "Get entry point" option. Software should use the PDC\_CONFIG "Return config info" call in conjunction with the PDC\_IODC "Get entry point" option to ascertain the modules that are physically present.

---

The "**Nondestructive init**" option (ARG1=2) is used to initialize a memory module and to determine the size of the module. It is expected that the operating system will call this option during powerfail recovery and during boot. The option does not change the contents of the data in the memory module and does not do any lengthy array tests. The option sets the SPA of the memory module identified by *hpa* to the base address given by *spa*. If the procedure returns status value -3 it must disable the memory module's SPA.

The format of the return parameter *stat* is the same as the I/O register IO\_STATUS.

The return parameter *max\_spa* specifies the size of the memory module's SPA space in bytes. *max\_spa* must be a power of two, and must be less than or equal to the value specified by the module's IODC\_SPA[shift] field.

The return parameter *max\_mem* specifies the amount of implemented memory in bytes. *max\_mem* must be strictly greater than 1/2 of *max\_spa*.

Executing this option clears the HVERSION-dependent versions of IO\_STATUS[fe], IO\_STATUS[he], IO\_STATUS[se], and IO\_STATUS[estat]. The IO\_STATUS[sl] bit is not changed by this option.

The sequence of events performed by the "Nondestructive init" option is as follows:

1. Initialize the memory SPA.
2. Return *max\_spa* and *max\_mem*.
3. Return error status in the RET[0] parameter. Error bits *he*, *se*, *fe*, *estat* are cleared in the HVERSION-dependent IO\_STATUS register after the call.

Following are the calling conventions for the "Nondestructive init" option:

- Software must not call the "Nondestructive init" option for a processor-dependent IMM or for a processor-dependent memory module which is a satellite of the IMM.

- Software may issue CMD\_RESET to processor-dependent memory modules before calling the "Nondestructive init" option. Software need not check for the completion of the reset command; PDC\_IODC must handle this.
- For every processor-dependent memory module which is a satellite of a module other than the IMM, that satellite must be reset or must have 0 written to its IO\_SPA register, before its SPA base can be changed by calling the "Nondestructive init" option for the primary memory module of its interleave group.
- Software must never call the "Nondestructive init" option for a processor-dependent memory module which has IODC\_SPA[shift] = 0 (a processor dependent satellite module). Effects of such a call are HVERSION dependent.

The "**Return and clear errors**" option (ARG1=4) checks for memory errors and clears the HVERSION-dependent equivalents of IO\_STATUS[sl,estat,se,he] for the processor-dependent memory module specified by the *hpa* argument. Only the status of the first error of the highest severity that has occurred since the routine was previously called is returned. If *fe* = 0, then all error fields must be cleared. If *fe* = 1, then *sl* and *estat* must not be cleared and *se* and *he* are HVERSION dependent.

The formats of *stat*, *resp*, *info*, and *req* are the same as the I/O registers IO\_STATUS, IO\_ERR\_RESP, IO\_ERR\_INFO, and IO\_ERR\_REQ, respectively. If the memory module does not support logging of the error requestor, the *req* return parameter is 0.

The "Return and clear errors" option is equivalent to the following sequence for an architected memory module:

```
RET[0] ← IO_STATUS;
RET[1] ← IO_ERR_RESP;
RET[2] ← IO_ERR_INFO;
RET[3] ← IO_ERR_REQ;
IO_COMMAND ← CMD_CLEAR.HE;
```

The "**Identify primary**" option (ARG1=5) identifies the primary memory module of an interleave group. ARG3 must be the *hpa* of a processor-dependent memory module which has IODC\_SPA[shift] = 0. If ARG3 is the *hpa* of a processor-dependent memory module configured as a satellite in an interleave group, then the *hpa* of the group primary is returned as *primary\_hpa*. If ARG3 is the *hpa* of a processor-dependent memory module which has IODC\_SPA[shift] = 0 but is not configured in an interleave group, then status -19 is returned.

## PDC\_MEM (index 20)

**Purpose:** To identify pages in which a memory error has been detected so that the module can be configured at boot time, but the page with the error will not be accessed by software. The firmware table which contains this information will be referred to as the Page Deallocation Table (PDT).

Arguments:	Description	ARG1	ARG2	ARG3	ARG4
	Return Information	0	R_addr	R	R
	Add Page	1	R_addr	PDT_addr	R
	Clear PDT	2	R_addr	R	R
	Read PDT	3	R_addr	PDT_entries_ptr	R
	Reset Clear Flag	4	R_addr	R	R
	Set Good Memory	5	R_addr	good_mem	R

Returns:	Description	RET[0]	RET[1]	RET[2]	RET[3]	RET[4]
	Return Information	PDT_size	page_entries	PDT_status	dbe_loc	good_mem
	Add Page	R	R	R	R	R
	Clear PDT	R	R	R	R	R
	Read PDT	page_entries	R	R	R	R
	Reset Clear Flag	R	R	R	R	R
	Set Good Memory	R	R	R	R	R

Status:	Value	Description
	5	Single bit error replaced. A double bit error replaced a single bit error, because the table was full. REQUIRED.
	4	Duplicate entry not added. An entry for the page to be added is already in the PDT. REQUIRED.
	3	Call completed with a warning. An error of unspecified type occurred, but the call completed correctly. OPTIONAL. The procedure need not report warning conditions.
	0	OK The call completed normally and the procedure detected no error. REQUIRED.
	-2	Nonexistent option ARG1 did not correspond to an option provided by the procedure. REQUIRED.
	-3	Cannot complete call without error An error of unspecified type prevented the call from completing correctly. CONDITIONAL. Must be used if indeterminate errors can be detected.
	-10	Invalid argument An argument other than ARG0 or ARG1 was invalid. OPTIONAL. The procedure need not check arguments for correctness.
	-11	Table full. An attempt to add an entry to the PDT failed because the table was full. REQUIRED.
	-12	Assertion of BUS_POW_WARN signal detected CONDITIONAL. Must be used if the procedure cannot satisfy the powerfail budget.

**Description:** The PDC\_MEM procedure is used to identify memory pages in which errors have been detected so that they will not be accessed by software.

PDC must maintain the PDT and the mapping between the real page number of each memory location and its physical hardware memory address (module, HVERSION dependent portion of a module, and address within portion of a module) uniquely across the system as tertiary state, and

preserve this information across boot and powerfail.

---

**SUPPORT NOTE**

If memory modules are physically swapped within a system, the PDT could be in error. This could cause unwanted effects.

Good locations would be erroneously listed, deallocating good memory, the PDT could become full, disabling page deallocation, or recurring but non-persistent uncorrectable errors could cause HPMCs.

Moving memory module should only be used as a last resort, and the PDT should be cleared prior to performing the physical swap.

---

**PROGRAMMING NOTE**

There are several conditions which cause entries to added to the PDT.

1. During destructive memory initialization when the system is being booted.
  2. When an HPMC occurs during normal operation.
  3. When software discovers a pattern or non-persistent errors to the same location.
- 

The "**Return Information**" option (ARG1=0) returns information about the PDT. The *PDT\_size* parameter returns the maximum number of entries in the PDT. The *page\_entries* parameter returns the number of pages currently listed to be deallocated. *page\_entries* is an unsigned 64 bit integer.

The *PDT\_status* parameter returns information concerning the action of the memory initialization process during boot. The format of the PDT\_status paramater is as follows:

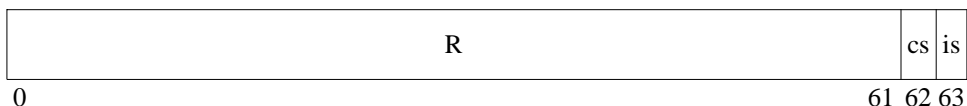

The *cs* or cleared status bit indicates whether the PDT has been cleared since the last call to the "**Reset Clear Flag**" option. A value of 0 indicates that "**Reset Clear Flag**" has been called since the the last time that the PDT was cleared. A value of 1 indicates that the PDT has been cleared since the last time that "**Reset Clear Flag**" was called. The PDT will be cleared whenever the CLEAR PDT option of PDC\_MEM is called or whenever memory initialization must clear the PDT because of reinterleaving.

A value of 1 in the *is* or interleaving changed bit indicates that during memory initialization, memory interleaving had to be changed in such a way that may reduce performance in order to enlarge the error free portion of initial memory. A value of 0 in the interleaving changed bit indicates that memory initialization did not reinterleave to enlarge the error free portion of initial memory.

The *dbe\_loc* parameter returns the location in memory where the first double bit error was detected. If no errors were detected this parameter is set to the value (2<sup>64</sup>)-1 (0xFFFFFFFFFFFFFFFF). *Dbe\_loc* is in byte address format. *dbe\_loc* is an unsigned 64 bit integer.

The *good\_mem* parameter returns the target value used by memory initialization to provide initial memory without double bit errors. *good\_mem* is a 64 bit unsigned integer indicating the number of bytes of good memory required.

The "**Add Page**" option (ARG1=1) adds a page to the PDT so that it will not be referenced by software. The PDT\_addr argument indicates the errored location whose page is to be added to the

PDT. The format of PDT\_addr is as follows:



The *phys\_addr* fields specifies bits 0 through 60 of the real address where the error was detected. The *error\_type* field is used to specify the type of error. The value 0 is used to indicate a double bit error. The value 1 is used to indicate a single bit error.

The "**Clear PDT**" option (ARG1=2) removes all entries from the PDT. In addition, it causes subsequent calls to the "**Return Information**" option to return a value of 1 for the cleared status bit of the *PDT\_status* parameter until "**Reset Clear Flag**" is called.

The "**Read PDT**" option (ARG1=3) reads the PDT, and return the information in a memory area provided by the caller. The *PDT\_entries\_ptr* argument is the pointer to that memory area. The memory area must be 8\*PDT\_size bytes in length and must be double word aligned. The *page\_entries* return parameter indicates the number of pages listed to be deallocated. For each entry in the PDT, one doubleword in the format of PDT\_addr is returned. The values are returned in a set of contiguous locations beginning at the location referenced by *PDT\_entries\_ptr*. Locations beyond the last PDT entry are HVERSION dependent.

The "**Reset Clear flag**" option causes subsequent calls to the "**Return Information**" option to return a value of 0 for the cleared status bit of the *PDT\_status* parameter until the PDT is cleared, either by a call to the "**Clear PDT**" option, or by PDC selftest during boot.

The "**Set Good Memory**" option sets the value of the *good\_mem* parameter returned by the "**Return Information**" option.



## PDC\_MODEL (index 4)

**Purpose:** To return the version numbers, identifiers, and capabilities of a processor, to set the BOOT\_ID of a processor, to return the version numbers of processor components, to return the system model information of a system, and to enable and disable the execution of product-specific instructions.

**Options:** Category A processors may optionally provide option ARG1=1; category B processors must provide option ARG1=1.  
Processors may optionally provide option ARG1=2 if they wish to support CVERSIONs.  
Processors that support any product-specific instructions must provide options ARG1=4 and ARG1=5. Processors that do not support any product-specific instructions must not provide options ARG1=4 and ARG1=5.

Arguments:	Description	ARG1	ARG2	ARG3	ARG4	ARG5	ARG6	ARG7
	Return info	0	R_addr	HV	---	---	---	---
	Set BOOT_ID	1	BOOT_ID	HV	---	---	---	---
	Return versions	2	R_addr	c_index	---	---	---	---
	Return system model	3	R_addr	OS_ID	mod_addr	R	R	R
	Enable specific	4	R_addr	enable_key	R	R	R	R
	Disable specific	5	R_addr	disable_key	R	R	R	R
	Return CPU ID	6	R_addr	R	R	R	R	R
	Return capabilities	7	R_addr	R	R	R	R	R
	Return boot test options	8	R_addr	R	R	R	R	R
	Set boot test options	9	R_addr	tests_off	tests_on	R	R	R
	Get Platform Info	10	op_addr	cp_addr	sn_addr	R	R	R
	Return Install Kernel	11	R_addr	name	alt_name	alt_size	OS_ver	R

Returns:	Description	RET[0]	RET[1]	RET[2]	RET[3]	RET[4]
	Return info	HVERSION	SVERSION	HV	BOOT_ID	SW_ID
	Set BOOT_ID	---	---	---	---	---
	Return versions	CVERSION	R	R	R	R
	Return system model	mod_len	R	R	R	R
	Enable specific	R	R	R	R	R
	Disable specific	R	R	R	R	R
	Return CPU ID	CPU_ID	phys_width	R	R	R
	Return capabilities	capabilities	R	R	R	R
	Return boot test options	current_tests	tests_controllable	default_tests	R	R
	Set boot test options	R	R	R	R	R
	Get Platform Info	R	R	R	R	R
	Return Install Kernel	act_count	R	R	R	R

Description	RET[5]	RET[6]	RET[7]	RET[8]	RET[9]
Return info	SW_CAP	arch_rev	potential_key	current_key	width
Set BOOT_ID	---	---	---	---	---
Return versions	R	R	R	R	R
Return system model	R	R	R	R	R
Enable specific	R	R	R	R	R
Disable specific	R	R	R	R	R
Return CPU ID	R	R	R	R	R
Return capabilities	R	R	R	R	R
Return boot test options	R	R	R	R	R
Set boot test options	R	R	R	R	R
Get Platform Info	R	R	R	R	R

Return Install Kernel | R R R R R

**Status:**

Value	Description
3	Call completed with a warning. An error of unspecified type occurred, but the call completed correctly. OPTIONAL. The procedure need not report warning conditions.
1	Valid <i>c_index</i> but no CVERSION returned Returned only by option ARG1=2. CONDITIONAL. Must be used if the implementation does not have a CVERSION for each valid <i>c_index</i> .
0	OK The call completed normally and the procedure detected no error. REQUIRED.
-2	Nonexistent option ARG1 did not correspond to an option provided by the procedure. REQUIRED.
-3	Cannot complete call without error An error of unspecified type prevented the call from completing correctly. CONDITIONAL. Must be used if indeterminate errors can be detected.
-4	Invalid <i>c_index</i> (nonexistent component) Returned only by option ARG1=2. REQUIRED.
-5	Invalid <i>OS_ID</i> (unknown operating system) Returned only by option ARG1=3. REQUIRED.
-10	Invalid argument An argument other than ARG0 or ARG1 was invalid. OPTIONAL. The procedure need not check arguments for correctness.
-12	Assertion of BUS_POW_WARN signal detected CONDITIONAL. Must be used if the procedure cannot satisfy the powerfail budget.
-20	Unsupported key A key not supported by this processor was requested. Returned only by options ARG1=4 and ARG1=5. REQUIRED.

**Description:** The "Return info" option (ARG1=0) returns the version numbers, identifiers, and capabilities of the processor module.

The value of **HVERSION** specifies the hardware version number for the processor as follows:

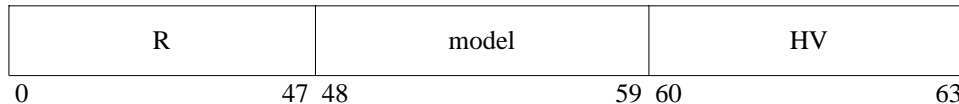

The *model* field specifies the hardware implementation, and is changed as required for implementations with incompatible diagnostic and/or system dependent software functionality.

The five most significant bits of *model* are the bus ID of the bus on which the processor module is located. See Section 5.5.6.1, IODC Data Bytes, for assignment of identifiers.

The value of **SVERSION** specifies the software version number for the processor as follows:

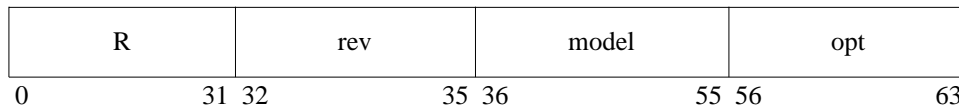

The *rev* field is 0x0 for all native processors.

The *model* field is 0x00004 for all native processors.

The definition of the SVERSION[opt] byte for native processors is:

sh	R	mc	R	lvl			
56	57	58	59	60	61	62	63

**sh** Indicates if shadow registers are present. If shadow registers are implemented, this field is a 1; this field is a 0 otherwise.

**mc** Specifies the module category. This bit is 0 for category A processors and 1 for category B processors.

**lvl** Specifies the native processor capability level (0, 1, 2, and 3 for Level\_0, Level\_1, Level\_1.5, and Level\_2, respectively).

All PA-RISC 2.0 processors are Level\_2 processors. For a description of how the number of actual address bits for these processors can be determined see the **Instruction TLB Parameters** description in the PDC\_CACHE procedure specification. The **BOOT\_ID** (boot identifier) word is used during monarch selection (see the PDCE\_RESET description in Section 3.2, PDC Entry Points). **BOOT\_ID** has the following format:

R	boot-id
0	61 62
	63

For a category A processor that does not provide the ARG1=1 option, RET[3] is HVERSION dependent.

For category B processors, **BOOT\_ID** must be set to 2 at manufacture time.

The **SW\_ID** (software identifier) word is a system-wide resource, and is a unique 64 bit unsigned integer (each system shipped has a different value). The **SW\_ID** is used for software licensing and security. The **SW\_ID** of each system must be set to a unique value at manufacture.

If the FRU containing the **SW\_ID** is replaced in the field, a secure mechanism must be used to set the **SW\_ID** in the new FRU equal to the **SW\_ID** in the original FRU. The mechanism is HVERSION-dependent for category A processors and SVERSION-dependent for category B processors. This ensures that the **SW\_ID** of the system is unchanged and that software licensed to the system will still execute.

The **SW\_CAP** (software capabilities) word specifies the operating system capabilities of the processor module as follows:

R	isl	R	netware	hp-rt	osf	mpe-ix	hp-ux
0	31 32	35 36	43 44	47 48	51 52	55 56	59 60
							63

**SW\_CAP** consists of the *netware* field for Novell Netware, the *hp-rt* field for HP-RT, the *osf* for OSF/1, the *mpe-ix* field for MPE-iX, and the *hp-ux* field for HP-UX. The operating system capabilities associated with each of these fields are as follows:

isl	Description
0	No ISL capability restrictions in effect
1-15	Defined by ISL
netware	Description
0	No Novell Netware capability restrictions in effect
1-15	Defined by the Novell Netware operating system
hp-rt	Description
0	No HP-RT capability restrictions in effect
1-15	Defined by the HP-RT operating system
osf	Description
0	No OSF capability restrictions in effect
1-15	Defined by the OSF operating system
mpe-ix	Description
0	No MPE-iX capability restrictions in effect
1-15	Defined by the MPE-iX operating system
hp-ux	Description
0	No HP-UX capability restrictions in effect
1-15	Defined by the HP-UX operating system

SW\_CAP is a per-processor resource. When each processor module is manufactured, the associated SW\_CAP is set to an appropriate value. When a processor module is replaced, the SW\_CAP of the new processor module must be set equal to the SW\_CAP of the processor module being replaced. SW\_CAP is updated when the operating system capabilities of the processor module are changed (e.g., when a system is upgraded).

Each implementation must provide an HVERSION-dependent mechanism, accessible by software, to change the SW\_CAP value. The ability to access the mechanism to change this value must be restricted to software executing at privilege level 0.

---

#### ENGINEERING NOTE

The architecture makes no requirement as to where the SW\_CAP value is physically stored; however, the intended use of SW\_CAP is dependent on implementations making SW\_CAP physically part of the processor module. SW\_CAP is envisioned as residing on the processor module when the processor module is installed in a system as an upgrade that replaces another processor, or is installed in a system as an additional processor.

---

#### SUPPORT NOTE

While the architecture allows each processor in a system to have a different value of SW\_CAP, the field support organization does not have a vehicle to manage multiple values of SW\_CAP for a single system. There are no plans to have more than one value of SW\_CAP for a system.

---

The *arch\_rev* field specifies the revision of the architected instruction set supported by the processor. The *arch\_rev* values are assigned by Computer Systems Architecture. Values of *arch\_rev* > 0 correspond to architected supersets of the original instruction set, as shown below:

arch_rev	Description
0	PA-RISC 1.0
4	PA-RISC 1.1
8	PA-RISC 2.0

The *potential\_key* word indicates which unprivileged, product-specific instructions are supported by the processor. Each bit position in *potential\_key* corresponds to a distinct group of product-specific instructions. If a bit in *potential\_key* is set to 1, then the processor supports the corresponding group of product-specific instructions; otherwise, it does not support them. Thus, *potential\_key*=0 indicates a processor that supports no product-specific instructions at all. The *key* values are assigned by the System Architecture Lab. A table showing the correspondence between bit positions and groups of product-specific instructions follows:

key	Description
0x00000001	Opcode 0x0F does quadword stores (as in PCX-S)
0x00000002	FSTWS, FSTWX, FLDWS, FLDWX generate word transactions to I/O space (as in PCX-T)
0x00000004	Floating point includes reciprocal square root (as in PCX-S)
0x00000008	Flush data cache includes graphics flushes (as in PCX-S & PCX-T)
0x00000010	Multimedia halfword shift-and-adds. (as in PCX-L and PCX-U)
0x00000020	Multimedia halfword adds and subtracts. (as in PCX-L and PCX-U)
0x00000040	Byte swapping stores (as in PCX-L)
0x00000080	Speculative Data Prefetch on Loads of GR0

The *current\_key* word indicates which product-specific instructions are enabled for execution on the processor. The allowable values of *current\_key* are 0, which indicates that the product-specific instructions are disabled (or that the processor supports no product-specific instructions at all), and *potential\_key*, which indicates that the product-specific instructions are enabled.

The *width* return parameter indicates the default W-bit of the system. Bit 63 is the value of the default W-bit. A value of 0 indicates narrow mode, a value of 1 indicates wide mode. The remainder of the return parameter is reserved. The "Set BOOT\_ID" option (ARG1=1) is used to set the BOOT\_ID of the processor module.

The "Return versions" option (ARG1=2) is used to identify the version number of each processor component. The argument *c\_index* is the processor component index; *c\_index* is an unsigned 64-bit integer. The meaning of each index is HVERSION dependent, but indexes must be assigned sequentially beginning at 0. This allows software to identify all components by repeated calls to PDC\_MODEL with increasing values of *c\_index* until status -4 (Invalid *c\_index*) is returned.

The CVERSION (component version) word specifies the version number for a component associated with the processor. The interpretation of CVERSION depends on the HVERSION of the processor.

The "Return system model" option (ARG1=3) returns the system model information of the system.

The OS\_ID argument is used to identify the operating system, and has the following format:

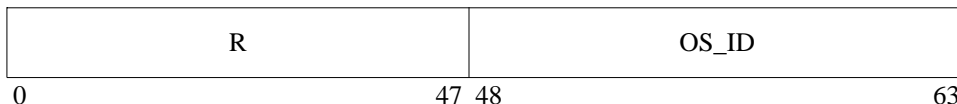

Refer to the description of the PDC\_STABLE procedure for further information about OS\_ID.

The *mod\_addr* argument points to a byte-aligned array into which the system model of the operating system indicated by OS\_ID is returned. A system model string can be up to 80 characters long and its length is returned in the 64 bit unsigned integer *mod\_len*. The format and content of each string is defined by the operating system to which it applies.



The NP (Non-Coherent IO-PDIR) bit indicates that SBA fetches from the IO-PDIR are not performed coherently. When this bit is set, the OS must explicitly DFlush and Sync to make IO-PDIR changes visible to the SBA. When this bit is clear, flushes and syncs are not required. This bit is only applicable to SBAs, and does not apply to Legacy IOAs.

Independent of the NP bit value, SBA IO-TLBs are not coherent in the sense of automatically invalidating a Translation Cache Entry when some entity fetches its associated line private. IO-TLB purges must be done explicitly by SW, using the SBA's Purge Command Register.

The SV (SBA\_VINDEX) bit indicates that the OS does not need to supply the Virtual Index (VINDEX) in the IO-TLB or DVI addresses to maintain coherency with processors. When this bit is set, the OS is allowed to use IO-TLB translations and DVI addresses greater than 4KB. This bit is only applicable to SBAs, and does not apply to Legacy IOAs.

The NVA (Non-equivalent Virtual Aliasing) field is a two bit field which indicates whether non-equivalent virtual aliasing is supported on the platform, and if so, if it has a performance impact. NVA field values are shown in the following table:

key	Description
0b00	Non-equivalent aliasing supported without performance penalty.
0b01	Non-equivalent aliasing supported with performance penalty.
0b10	Reserved
0b11	Non-equivalent aliasing not supported. Data corruption or HPMCs may result.

If the call returns "Invalid Argument" for ARG1, indicating the "**Return capabilities**" option is not implemented, software should assume that the platform is capable of supporting 32-bit Oses, but is not capable of supporting 64-bit Oses or any 64-bit capabilities.

The "**Return boot test options**" option (ARG1=8) returns a three values which describe the boot tests supported and controllable on the platforms, and their current status regarding whether to be run or not. Each return parameter is formatted a boot Test Option Map, shown in the following figure:

Reserved				Reserved				CEC	PDH	MEM	EP	LP
0		31	32			58	59	60	61	62	63	

- The *CEC* bit refers to Central Electronic Complex tests. This may include I/O bridges and system interconnect media.
- The *PDH* bit refers to Processor Dependent Hardware tests. This may include boot ROM and RAM and any special hardware (eg: semaphores) required by PDC.
- The *MEM* bit refers to Destructive Memory tests. This is the set of architected memory tests described in Chapter 11 of this document.
- The *EP* bit refers to Early Processor tests that are run before memory and most of the interconnect and I/O system are available.
- The *LP* bit refers to Late Processor tests that are run after memory, interconnect, and I/O are available.

The *current\_tests* return value indicates which tests are currently set to be run on each boot of the system.

The *tests\_controllable* return value indicates which tests can be turned on or off during system boot.

The *default\_tests* return value indicates which tests are enabled when the system is manufactured and shipped.

In each case, a 1 bit indicates enabled, and a 0 bit indicates disabled.

The "**Set boot test options**" option (ARG1=9) provide a mechanism to enable and disable specific tests. The *tests\_off* argument selects a specific set of tests to disable. The *tests\_off* argument is formatted as a Boot Test Option Map, and a 1 bit in a specific position indicates to disable the corresponding test. The *tests\_on* argument selects a specific set of tests to enable. The *tests\_on* argument is formatted as a Boot Test Option Map, and a 1 bit in a specific position indicates to enable the corresponding test.

If an attempt is made to enable and disable the same test at the same time, or if an attempt is made to enable or disable an unsupported test, if an attempt is made to turn off a supported test which is not controllable, or if a bit is set in a reserved field, "**Set boot test options**" will return an Invalid Argument Status. If a test which is already disable is disabled, or a test which is already enabled is enabled, "**Set boot test options**" will simply perform the action normally.

The "**Get Platform Info**" option (ARG1=10) returns the original product number, current product number, and serial number of the system on which the call is made. The *op\_addr* argument is a pointer to a memory buffer in which the original product number will be returned. The *cp\_addr* argument is a pointer to a memory buffer in which the current product number will be returned. The *sn\_addr* argument is a pointer to a memory buffer in which the serial number of the product will be returned. All three buffers must be double word aligned, and all three values are returned as null-terminated ASCII strings. It is the responsibility of the calling software to ensure that the buffers are large enough to hold the return values. All are required to be less than 16 bytes in length.

The "**Return Install Kernel**" option (ARG1=11) allows the platform to specify to the OS loader which install kernel should be loaded. The *name* argument is a pointer to an ASCII string which has the name of the default install kernel the OS loader will use if none is specified by the platform. The *alt\_name* argument is a pointer to a memory area where PDC can write the name of the install kernel to be used with the platform. The *alt\_size* argument is an unsigned 64-bit integer denoting the size of the memory buffer pointed to by *alt\_name*. It should be large enough to hold an ASCII string naming any install kernel which the OS loader would be expected to load. The *OS\_ver* argument is a 64-bit unsigned integer specifying the OS version requesting the install kernel name. A value of 0 indicates Version 10.xx or earlier. A value of 1 indicates 11.00 or later. All other values are reserved. There is one return parameter, *act\_count*. It's value is the number of bytes written by PDC to the buffer pointed to by *alt\_name*. A value of 0 indicates that no name was written and that the default name should be used. This procedure option is optional. If it is not implemented, the OS loader will load the default install kernel.



## PDC\_NVOLATILE (index 11)

**Purpose:** To provide access to Non-Volatile Memory.

Arguments:	Description	ARG1	ARG2	ARG3	ARG4
	Read data	0	nvaddr	memaddr	count
	Write data	1	nvaddr	memaddr	count
	Return size	2	R_addr	HV	---
	Verify contents	3	HV	HV	---
	Initialize	4	HV	HV	---

Returns:	Description	RET[0]
	Read data	---
	Write data	---
	Return size	size
	Verify contents	---
	Initialize	---

Status:	Value	Description
	3	Call completed with a warning. An error of unspecified type occurred, but the call completed correctly. OPTIONAL. The procedure need not report warning conditions.
	1	Correctable error The call completed normally and the returned results are valid. The procedure encountered an error which it was able to correct completely. Returned only by options ARG1=0, 1, 3, and 4. CONDITIONAL. Must be used if PDC_NVOLATILE performs error recovery.
	0	OK The call completed normally and the procedure detected no error. REQUIRED.
	-2	Nonexistent option ARG1 did not correspond to an option provided by the procedure. REQUIRED.
	-3	Cannot complete call without error An error of unspecified type prevented the call from completing correctly. CONDITIONAL. Must be used if indeterminate errors can be detected.
	-5	Invalid NVM contents Returned only by options ARG1=0, 1, 3, and 4. REQUIRED.
	-10	Invalid argument An argument other than ARG0 or ARG1 was invalid. CONDITIONAL. Must be returned by ARG1=0 or 1 if $nvaddr+count > size$ . Otherwise, the procedure need not check arguments for correctness.
	-12	Assertion of BUS_POW_WARN signal detected CONDITIONAL. Must be used if the procedure cannot satisfy the powerfail budget.

**Description:** **Non-Volatile Memory (NVM)** is an optional storage area used to maintain system parameters during power outages. NVM is required to retain its contents even if the card containing it is removed from the backplane. NVM is used during boot and in the event of an OS panic.

Non-Volatile Memory is a system-wide resource shared by all processors in a multiprocessor system. Software must ensure that at most one call to PDC\_NVOLATILE is in progress at any one time.

The integrity of NVM is verified in an HVERSION-dependent fashion.

Non-Volatile Memory must not have a lifetime write cycle limit.

The "**Read data**" option (ARG1=0) transfers *count* bytes from NVM address *nvaddr* to memory address *memaddr*. *count* is an unsigned 64-bit integer which is a multiple of eight. *nvaddr* and *memaddr* must be double word aligned. The call must return -10 if  $nvaddr+count > size$ .

Reads must validate data integrity for the bytes being read. If a checksum algorithm is used, this may involve validating all of NVM. If the data integrity check fails, the call must return -5 and (if possible) the potentially bad data.

The "**Write data**" option (ARG1=1) transfers *count* bytes from memory address *memaddr* to NVM address *nvaddr*. *count* is an unsigned 64-bit integer which is a multiple of eight. *nvaddr* and *memaddr* must be double word aligned. The call must return -10 if  $nvaddr+count > size$ .

If a write to NVM is interrupted due to a powerfail, reset or TOC, and if PDC cannot guarantee that the write completed, then it must ensure that data integrity checks fail on subsequent accesses to NVM.

---

#### ENGINEERING NOTE

A recommended method to check the validity of NVM is to include a checksum in a non-architected tertiary state storage area. This checksum should be designed such that NVM filled with all zeroes or all ones will not generate a valid checksum.

If a write to NVM is interrupted by a powerfail, reset, or TOC, hardware implementations should attempt to limit the extent of damage to the words that were being modified. This rule applies except for genuine hardware failures or sudden power failures. For such failures, the extent of damage cannot be predicted.

---

The "**Return size**" option (ARG1=2) returns the number of bytes in the processor's NVM. *size* is the number of contiguous bytes implemented in NVM starting from  $nvaddr=0$ . *size* is an unsigned 64-bit integer and must be a multiple of eight.

The "**Verify contents**" option (ARG1=3) verifies that the NVM contents are valid.

The "**Initialize**" option (ARG1=4) sets the entire NVM contents to zero and initializes the validity indicator.

---

#### PROGRAMMING NOTE

An algorithm to restore NVM in the event of a failure follows:

1. Copy out the entire contents of NVM into memory.
2. Fix all the bad values by correcting the copied values in memory.
3. Call the "Initialize" option to zero NVM.
4. Write the good copy from memory to NVM.
5. Call the "Verify contents" option to check for successful completion.

To protect against a powerfail after the "Initialize" option has zeroed NVM, but before the new values are written back, software should back up the contents on disk before zeroing, or be able to reconstruct NVM from the all zero state.

---

---

**ENGINEERING NOTE**

Specific products may choose to implement multiple copies of Non-Volatile Memory to increase the fault tolerance of the system, but this must be transparent to the callers of PDC\_NVOLATILE.

---

## Data Format of Non-Volatile Memory

The format of Non-Volatile Memory is as follows:

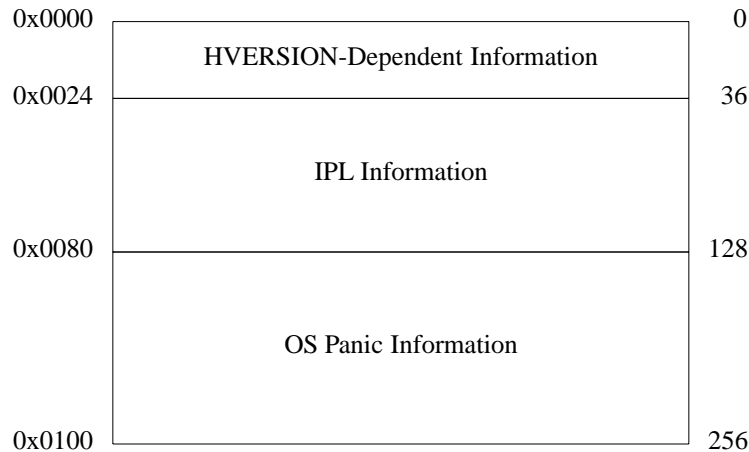

Providing Non-Volatile Memory is optional. If Non-Volatile Memory is provided, it must be at least 256 bytes in size and must be used for the architected purposes.

### HVERSION-Dependent Information

The first 36 bytes of NVM are HVERSION dependent.

### IPL Information

The 92-byte area starting at address 36 is allocated for IPL to save initialization information. This area is used by ISL to store the following information:

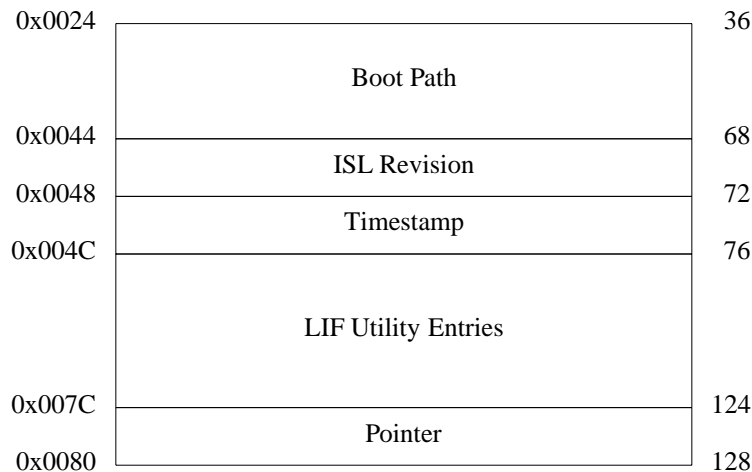

### OS Panic Information

The 128-byte area starting at address 128 is allocated for the OS to save panic information. The format of this area is OS\_ID dependent.

## PDC\_PIM (index 3)

**Purpose:** To access Processor Internal Memory (PIM).

**Options:** All processors must provide the ARG1=0, ARG1=1, and ARG1=4 options. Processors that support LPMCs must provide the ARG1=2 option; other processors do not provide the option. The implementation of the ARG1=3 option is required for category B processors; category A processors do not provide the option.

Arguments:	Description	ARG1	ARG2	ARG3	ARG4
	Transfer HPMC data	0	R_addr	memaddr	count
	Return size	1	R_addr	HV	---
	Transfer LPMC data	2	R_addr	memaddr	count
	Transfer Soft boot data	3	R_addr	memaddr	count
	Transfer TOC data	4	R_addr	memaddr	count

Returns:	Description	RET[0]	RET[1]
	Transfer HPMC data	actcnt	HV
	Return size	size	HV
	Transfer LPMC data	actcnt	HV
	Transfer Soft boot data	actcnt	HV
	Transfer TOC data	actcnt	HV

Status:	Value	Description
	3	Call completed with a warning. An error of unspecified type occurred, but the call completed correctly. OPTIONAL. The procedure need not report warning conditions.
	0	OK The call completed normally and the procedure detected no error. REQUIRED.
	-2	Nonexistent option ARG1 did not correspond to an option provided by the procedure. REQUIRED.
	-3	Cannot complete call without error An error of unspecified type prevented the call from completing correctly. CONDITIONAL. Must be used if indeterminate errors can be detected.
	-5	Invalid PIM contents Returned only by options ARG1=0, 2, 3, and 4. REQUIRED. The event did not occur or the contents are invalid due to power-on, a hard reset, the overwriting rules, or a subsequent call to transfer the same PIM data.
	-10	Invalid argument An argument other than ARG0 or ARG1 was invalid. OPTIONAL. The procedure need not check arguments for correctness.
	-12	Assertion of BUS_POW_WARN signal detected CONDITIONAL. Must be used if the procedure cannot satisfy the powerfail budget.

**Description:** PIM is a per-processor, HVERSION-dependent storage area in the processor set at the time of an HPMC, LPMC, TOC, or Soft boot. Processors may optionally store PIM information in any of the processor-dependent areas below MEM\_FREE.

The purpose of PIM is threefold:

- To help identify a failed FRU for support (for HPMCs and LPMCs)
- To save the processor's state at the time of a TOC or Soft boot for later analysis and, in the case of TOC, to determine if the interrupted process can be resumed.

- To determine what recovery action should be taken.

The storage for any two or more of the four events may optionally be shared. When the storage is shared, the following table specifies the overwriting rules.

		Current PIM Contents			
		HPMC	TOC	Soft Boot	LPMC
Event	HPMC	No	Yes	Yes	Yes
	TOC	No	No	No	Yes
	Soft Boot	No	No	No	Yes
	LPMC	No	No	No	No

If the PIM contents are overwritten or they could not be stored because of the overwriting rules, a PDC\_PIM call to transfer the overwritten data must return status -5 to indicate that the PIM contents are invalid.

At power-on or after hard reset, the PIM contents must become invalid.

PDC\_PIM transfers the contents of PIM into memory. The image of PIM in memory consists of two types of information: information about the processor state, and information about the error. Additionally, some HVERSION-dependent information may be returned.

For an HPMC, information about the processor state and the machine check is returned. For an LPMC, only information about the machine check is returned. For Soft boot, only information about the processor state is returned. For TOC, information about the processor state and the damage done by the TOC is returned.

PDC\_PIM uses separate options for transferring HPMC, LPMC, Soft boot, and TOC data. For these options, PDC\_PIM transfers data from PIM into the memory address specified by *memaddr*, which is a doubleword-aligned memory address. The value of *count* (which is an unsigned 64-bit multiple of 8) specifies the number of bytes available in the buffer at *memaddr*. One return parameter is defined. The value of *actent*, also an unsigned 64-bit multiple of 8, is the actual number of bytes transferred. If the number of bytes in the PIM image exceeds the *count* parameter, only *count* bytes are transferred. Subsequent transfer requests to return the same PIM data must return a status value of -5.

Another option ("Return size") is used to inform the caller how large a buffer is needed to hold the PIM data. The parameter returned by this option applies to all the other options. The option returns *size*, the total size of the PIM image, which is an unsigned 64-bit multiple of 8.

The "**Transfer HPMC data**" option (ARG1=0) returns information about the processor state and the machine check condition in the following format:

0x00000000	General Registers GR0 - GR31	0
0x00000100	Control Registers CR0 - CR31	256
0x00000200	Space Registers SR0 - SR7	512
0x00000240	IIA Space (back entry)	576
0x00000248	IIA Offset (back entry)	584
0x00000250	Check Type	592
0x00000254	CPU State	596
0x00000258	Cache Check	600
0x0000025C	TLB Check	604
0x00000260	Bus Check	608
0x00000264	Assists Check	612
0x00000268	Assist State	616
0x0000026C	Path Info	620
0x00000270	System Responder Address	624
0x00000278	System Requestor Address	632
0x00000280	Floating-Point Registers FPR0 - FPR31	640
0x00000380		896

The "**Return size**" option (ARG1=1) returns *size*, the maximum total size of PIM. This option must not modify the contents of PIM or re-enable error collection. The *size* parameter has a constant value for any particular implementation; the operating system can read this once and allocate sufficient buffer space for reading PIM.

The "**Transfer LPMC data**" option (ARG1=2) returns information about the machine check condition in the following format:

0x00000000		0
	HVERSION Dependent	
0x00000250	Check Type	592
0x00000254	HVERSION Dependent	596
0x00000258	Cache Check	600
0x0000025C	TLB Check	604
0x00000260	Bus Check	608
0x00000264	Assists Check	612
0x00000268	Assist State	616
0x0000026C	Path Info	620
0x00000270	System Responder Address	624
0x00000278	System Requestor Address	632
0x00000280	Floating-Point Registers FPR0 - FPR31	640
0x00000380		896



The "**Transfer Soft boot data**" option (ARG1=3) returns information about the processor state in the following format:

0x00000000	General Registers GR0 - GR31	0
0x00000100	Control Registers CR0 - CR31	256
0x00000200	Space Registers SR0 - SR7	512
0x00000240	IIA Space (back entry)	576
0x00000248	IIA Offset (back entry)	584
0x00000250	HVERSION Dependent	592
0x00000254	CPU State	596
0x00000258		600

The "**Transfer TOC data**" option (ARG1=4) returns information about the processor state and the damage done by the TOC in the following format:

0x00000000	General Registers GR0 - GR31	0
0x00000100	Control Registers CR0 - CR31	256
0x00000200	Space Registers SR0 - SR7	512
0x00000240	IIA Space (back entry)	576
0x00000248	IIA Offset (back entry)	584
0x00000250	HVERSION Dependent	592
0x00000254	CPU State	596
0x00000258		600



The following table describes how the *iqv*, *iqf*, and *ipv* bits qualify the CPU state:

<i>iqv</i>	<i>iqf</i>	<i>ipv</i>	Meaning
0	0	0	The IIA queues reflect the state that would have occurred if the HPMC had been processed as a Group 1 interruption.
1	0	0	The IIA queues reflect the state that would have occurred if the HPMC had been processed as a Group 2 interruption.
1	1	0	The IIA queues reflect the state that would have occurred if the HPMC had been processed as a Group 3 interruption.
1	1	1	The IIA queues reflect the state that would have occurred if the HPMC had been processed as a Group 3 interruption and the IIR contains the instruction causing the failure.

No other combinations of these three bits are allowed. Refer to *Precision Architecture and Instruction Reference Manual* for a description of how Group 1, 2, and 3 interruptions are processed.

The IA queues are defined when the IPSW Q-bit is zero, but do not point to the failure.

### Error Parameters

A portion of PIM is used to return machine independent indicators of the failure. The nature of a failure is passed to the PDC\_PIM caller by setting nonzero values in the appropriate fields. By providing as much information as possible to software, it is more likely that rebooting the system will be not be necessary. This information is provided only for HPMCs, LPMCs, and TOCs, and is presented hierarchically.

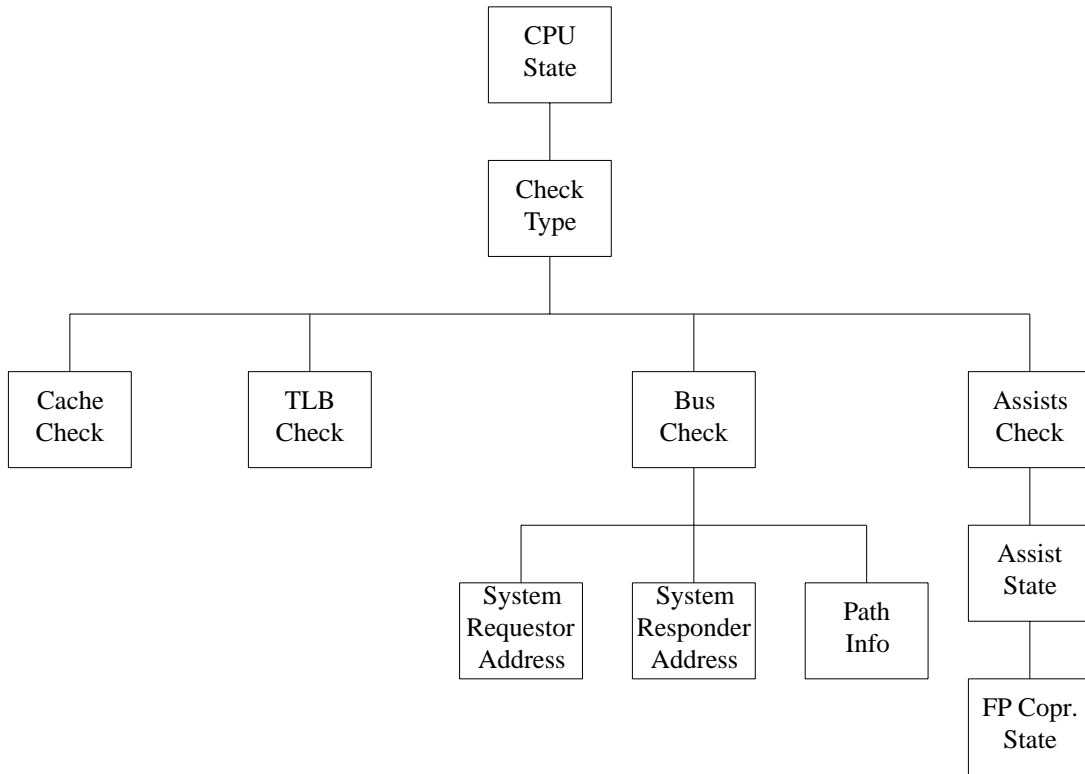

## CPU State

### CPU State word format for HPMC

The applicable portion of the CPU State word for the HPMC option (ARG1=0) is as follows:

R	tl	hd	sis	cs
7	25 26	27 28 29 30		31

Field	Description
tl	Trap Lost. This field indicates which, if any, of the Group 4 interruptions were lost as a result of taking the HPMC. This field is only valid when CHECK_ISOLATED is logged.
hd	Hardware Damage. This bit is used to indicate that some processor hardware is damaged and so this processor must no longer be used, although certain minimum functionality is available. This bit is only valid when CHECK_ISOLATED or CHECK_CRITICAL is logged.
sis	Storage Integrity Synchronized. This bit is used to describe the point of storage integrity. This bit is only valid when CHECK_ISOLATED is logged.
cs	Check Severity. This field is used to determine the severity of the HPMC.

When there is hardware damage, software must avoid the following until the processor is replaced:

- Access of any of the TLB functionality.
- Access of any assist processor functionality.
- PDC calls except for PDC\_PIM, PDC\_CHASSIS, PDC\_CONFIG, and PDC\_PROC.

Encoding for the *tl* field:

tl	Meaning
0	no Group 4 interruption lost
1	the HPMC caused the loss of a higher-privilege transfer trap
2	the HPMC caused the loss of a lower-privilege transfer trap
3	the HPMC caused the loss of a taken branch trap

The check severity field, *cs*, allows OS\_HPMC to determine the error severity, and thus what actions need to be taken. The interpretation of the encodings of the check severity field is as follows:

Value	Name	Description
0	CHECK_CRITICAL	An error has occurred which hardware determines to be serious enough to require a reboot. This may be because hardware has lost information about the error, or because there is no way to encode the error in PIM. This indicates a possible lack of storage integrity.
1	CHECK_TRANSPARENT	An error has occurred but has been fully corrected or circumvented in a way transparent to software. There must be synchronized storage integrity for this encoding to be logged.
2-3	CHECK_ISOLATED	An error has occurred but the PIM contents must be used by OS_HPMC to determine the error severity and decide what recovery actions are required. There must be storage integrity for this encoding to be logged, although it may not be synchronized.

If CHECK\_CRITICAL is logged, all PIM error parameters other than the CPU State word are HVERSION dependent.

---

### SUPPORT NOTE

Implementations are encouraged, when logging CHECK\_CRITICAL, to set all other indicators describing the error in PIM to valid information about the error.

---

If CHECK\_ISOLATED is logged, hardware must consider whether the error would remain isolated through recovery. For example, discovering an error in a dirty data cache line must not be logged as CHECK\_ISOLATED if it might be written back to memory without signalling the error before recovery is effected.

Logging CHECK\_TRANSPARENT indicates that the error was completely corrected by PDCE\_CHECK; that is, OS\_HPMC need only execute an RFI to resume normal system operation (provided that the CPU state in PIM is valid). Problems which require OS\_HPMC recovery action, or which may have altered architectural state observable to software must not be logged as CHECK\_TRANSPARENT. (Invalidating TLB entries, for example, is not always transparent, since software relies on certain translations remaining in the TLB.) All other fields in PIM must contain valid information about the error.

Logging CHECK\_TRANSPARENT indicates that there is storage integrity, and that if  $iqv=1$  and IPSW Q-bit=1, the IIA queues indicate the point of storage integrity

Although logging CHECK\_ISOLATED indicates that there is storage integrity, nothing is asserted about the point of storage integrity. The Storage Integrity Synchronized bit, *sis*, describes the point of storage integrity. If CHECK\_ISOLATED is logged and  $iqv=1$ , a value of one means that the point of storage integrity is at the place pointed to by the queues. In other words, all stores up to the place pointed to by the queues have been completed, and no stores at or beyond the place pointed to by the queues have been completed. If CHECK\_ISOLATED is logged and  $iqv=1$ , a value of zero means that the point of storage integrity may be before or after the place pointed to by the queues. In this situation, the processor has stopped updating cache and memory at some point, but has then gone ahead or rolled back such that the queues do not reflect the actual point where memory updating stopped.

---

### PROGRAMMING NOTE

Software conventions could be built to consider actions other than rebooting when the *sis* bit is zero. This might involve maintaining a log in memory with an entry for each context switch. From this log, then, it could be determined which process was running when the processor stopped storing.

---

### CPU State word format for Soft boot

The applicable portion of the CPU State word for the Soft Boot option (ARG1=3) is as follows:

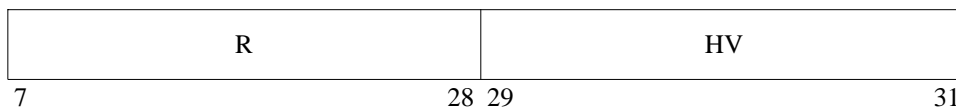

### CPU State word format for TOC

The applicable portion of the CPU State word for the TOC option (ARG1=4) is as follows:

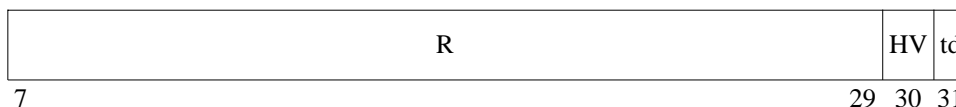

The *td* field defines the error severity due to TOC, as follows:

Value	Description
0	TOC has caused system damage and a reboot is necessary.
1	TOC did not cause any damage to the system state and no queued-up transactions in the processor module were aborted.

### Detailed Error Information

For HPMCs and LPMCs, additional indicators are defined to provide more detailed information about the machine check. These indicators are valid only when certain validity bits are set.

Indicator	Condition when Valid
Check Type	Always
Cache Check	Check Type[c]=1
TLB Check	Check Type[t]=1
Bus Check	Check Type[b]=1
Assists Check	Check Type[a]=1
Assist State	Check Type[a]=1 and (Assists Check[coc]=1 or Assists Check[sc]=1)
Sys. Resp. Address	Check Type[b]=1 and Bus Check[rsv]=1
Sys. Req. Address	Check Type[b]=1 and Bus Check[rqv]=1
Path Info	Check Type[b]=1 and Bus Check[piv]=1
FP Copr. State	Check Type[a]=1, Assists Check[coc]=1, and Assist State[fps]=2

For HPMCs, CHECK\_ISOLATED or CHECK\_TRANSPARENT must also be logged for these indicators to be valid.

### Check Type

The Check Type word allows the Operating System to determine where the machine state is potentially corrupt and if functionality of the system is reduced. Each bit of the word corresponds to a major functional area of the processor which could have caused the machine check.

The format of the Check Type word is as follows:

c	t	b	a	R																								HV			
0	1	2	3	4																									30	31	
Field	Description																														
c	Cache Check. If $c=1$ , the Cache Check word is valid.																														
t	TLB Check. If $t=1$ , the TLB Check word is valid.																														
b	Bus Check. If $b=1$ , the Bus Check word is valid.																														
a	Assists Check. If $a=1$ , the Assists Check word is valid.																														

### Cache Check

The format of the Cache Check word is as follows:

icc	dcc	tc	dc	crg	lc	rcc	R	padd																								
0	1	2	3	4	5	6	7	8																								31

Field	Description
<i>icc</i>	I-cache check. The failure is located in the I-cache.
<i>dcc</i>	D-cache check. The failure is located in the D-cache or a combined cache.
<i>tc</i>	Tag check. The failure is in the tag portion of some D-cache or combined cache line.
<i>dc</i>	Data check. The failure is in the data portion of some D-cache or combined cache line.
<i>crg</i>	Reconfiguration. Reconfiguration has occurred in the I-cache or D-cache.
<i>lc</i>	Line corrupt. The failure resulted in loss of tag, data, or status in some cache line.
<i>rcc</i>	Remote cache coherence. When set, the generation of coherent operations has been disabled; PDC_CACHE must be called before coherent operations may be issued.
<i>padd</i>	Physical address. The <i>padd</i> field contains bits 28 through 51 of the physical address of the failing line and is valid only if <i>tc</i> =0 and <i>lc</i> =1.

The *icc* and *crg* bits are used for reporting errors in the I-cache. The *dcc*, *tc*, *dc*, *crg*, *lc*, and *padd* bits are used for reporting errors in a D-cache or combined cache. If *dcc* is 0, *tc*, *dc*, *lc*, and *padd* must all be zero. If the *lc* bit is 1, data which may have been dirty was lost from the cache, and software action is necessary. If the *tc* bit is also 1, it is not known where in memory the line containing the lost data came from. If *tc* is 0, the *padd* field contains the physical page number of the page containing the lost data. The high order bits of the physical page number are contained in the *cache-padd-high* field of the Assists Check word. This might result in a reboot, depending on whether this page belonged to a critical process or not. If the *lc* bit is 0, no data has been lost and no software action is required.

The encodings of various cache errors using this word is as follows:

<i>icc</i>	<i>dcc</i>	<i>tc</i>	<i>dc</i>	<i>lc</i>	Description
1	0	0	0	0	The error was in the I-cache.
0	1	X	X	0	The error was in some clean D-cache line. The <i>tc</i> and <i>dc</i> fields indicate whether the error was in the tag or data portion of the cache.
0	1	0	1	1	The error was in the data portion of some dirty D-cache line. This error situation signals the corruption of the data at physical address <i>padd</i> .
0	1	1	0	1	The error was in the tag portion of some D-cache line.

Hardware is not required to report any reconfiguration information.

---

#### SUPPORT NOTE

To increase system diagnosability, implementations are encouraged to inform the OS about corrected cache errors and cache reconfiguration.

---

## TLB Check

The format of the TLB Check word is as follows:

itc	dtc	trg	tuc	tnf	R																										
0	1	2	3	4	5	31																									

Field	Description
itc	ITLB Check. The failure is located in the ITLB.
dtc	DTLB Check. The failure is located in the DTLB or a combined TLB.
trg	Reconfiguration. Reconfiguration has occurred in the ITLB or DTLB.
tuc	TLB Unchanged. When set, PDCE_CHECK has not invalidated, removed, or initialized all or part of the TLB system.
tnf	TLB Nonfunctional. When set, the TLB subsystem (including the space registers) is nonfunctional and access to it may cause unpredictable results.

When the TLB subsystem is nonfunctional, software must avoid the following:

- Execution of any of these instructions: BLE, IDTLBA, IDTLBP, IITLBA, IITLBP, LDSID, LHA, LPA, MFSP, MTSP, PDTLB, PDTLBE, PITLB, PITLBE, PROBER, PROBERI, PROBEW, PROBEWI, PDC, FDC, FIC.
- The setting to 1 of the PSW C, P, and D-bits.
- Execution of MTCTL or MFCTL which references any of these control registers:
  - CR 8 (PID 1)
  - CR 9 (PID 2)
  - CR 12 (PID 3)
  - CR 13 (PID 4)
  - CR 20 (Interruption Space Register)
  - CR 21 (Interruption Offset Register)

Since the FDC instruction must not be used when the TLB is nonfunctional, OS\_HPMC must flush the entire cache using FDCE instructions if it wants to flush any item from the data cache.

Hardware is not required to report any reconfiguration information.

---

### SUPPORT NOTE

To increase system diagnosability, implementations are encouraged to inform the OS about any reconfiguration in the TLB(s).

---



## Bus Check

The format of the Bus Check word is as follows:

HV	rsv	rqv	var	type	size	piv	bsv	busstat					
0	9	10	11	12	15	16	19	20	23	24	25	26	31

Field	Description
rsv	when set, the System Responder Address word is valid
rqv	when set, the System Requestor Address word is valid
var	indicates the variant of the transaction in which the error occurred
type	indicates the type of the transaction in which the error occurred
size	indicates the size of the transaction in which the error occurred
piv	when set, the Path Info word is valid
bsv	error severity for bus errors
busstat	encodings for architected bus errors

Encoding for the *var* field:

Variant	Description
0	Unknown or illegal variant
1	DFLT
2	INV
3	SH
4	PVT
5	SH_PVT
6	COH
7	Reserved
8-15	Bus Spec. Dep.

Encoding for the *type* field:

Type	Description
0	Unknown or illegal type
1	READ
2	WRITE
3	CLEAR
4	READ_REQ
5	READ_RESP
6	CLEAR_REQ
7	NULL
8	PDC
9	FDC
10	FIC
11	SYNC
12	PDTLB
13	PITLB
14-15	Reserved

Encoding for the *size* field:

Size	Description
0	Unknown or illegal size
1	1 byte
2	2 byte
3	4 byte
4	Reserved
5	16 byte
6	32 byte
7	64 byte
8	128 byte
9	256 byte
10	512 byte
11	1024 byte
12	2048 byte
13	4096 byte
14	Reserved
15	No size <sup>1</sup>

Notes:

1. Required for PDC, FDC, FIC, SYNC, PDTLB, PITLB, and NULL transactions. Not allowed for other transactions.

Encoding for the *bsv* field:

bsv	Severity
0	Fatal
1	Soft

Encoding for the *busstat* field:

busstat	Error
0	ERR_DEPEND
1	ERR_UNIMPL
2	Reserved
3	ERR_MODE_RS
4	ERR_ERROR_RQ
5	ERR_PARITY_RS
6	ERR_PROTOCOL_RQ
7	ERR_ADDRESS_RQ
8-12	Reserved
13	HV
14	Reserved
15	ERR_BUS_RQ
16-23	HV
24-49	Reserved
50	ERR_RESPONSE
51	ERR_BUS_RS
52	ERR_ERROR_RS
53	ERR_PARITY_RQ
54	ERR_PROTOCOL_RS
55	ERR_ADDRESS_RS
56	ERR_MODE_RQ
57-58	Reserved
59	ERR_TIMEOUT
60	ERR_RETRY
61	Reserved
62	ERR_IMPROP
63	Reserved

**Assists Check**

The format of the Assists Check word is as follows:

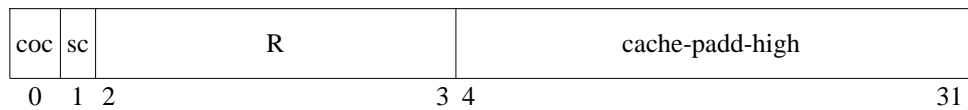

Field	Description
coc	Coprocessor Check. If <i>coc</i> =1, bits 0..15 of the Assist State word are valid.
sc	SFU Check. If <i>sc</i> =1, bits 16..31 of the Assist State word are valid.
cache-padd-high	Cache Physical Address. If Cache Check [ <i>tc</i> ] = 0 and Cache Check [ <i>lc</i> ] = 1, this field is valid. See Cache Check.

**Assist State**

The format of the Assist State word is as follows:



The *fps* field defines the floating-point coprocessor (*uid=0* or *uid=1*) state:

Value	Description
0	The coprocessor is functional but its state is invalid and is not saved in PIM.
1	The coprocessor has failed and its state is not saved in PIM.
2	The coprocessor has failed but its state has been saved in PIM.
3	Reserved

When the floating-point coprocessor has failed (*fps* = 1 or 2), software must not execute any floating-point instruction until the CCR bit 0 is cleared.

### System Responder Address

The System Responder Address doubleword identifies the system responder of a failed operation; its format is as follows:

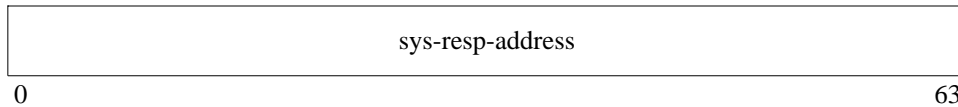

The number of bits in this field which are valid depends on the operation size. Valid bits are 0..*n*, where  $n = 63 - \log_2(\text{size})$ ; the remaining bits are HVERSION dependent. Since the largest system operation size is 4 Kbytes, bits 0..51 are always valid when *rsv=1*.

### System Requestor Address

The System Requestor Address doubleword identifies the system requestor of a failed operation; its format is as follows:

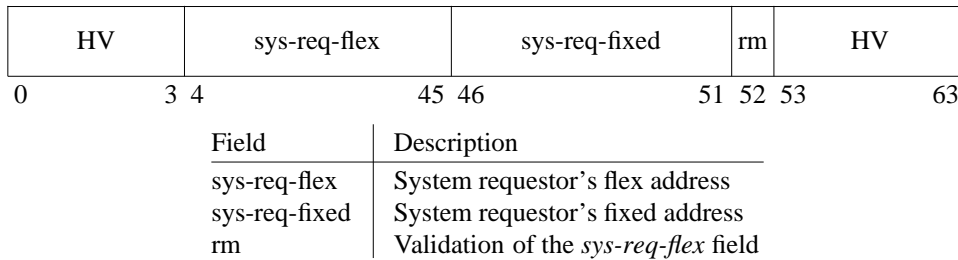

### Path Info

The format of the Path Info word is as follows:

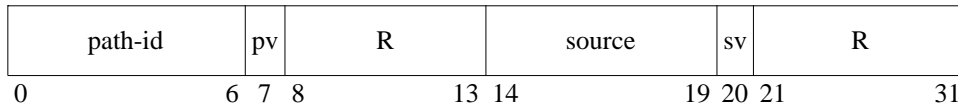

The *path-id* field indicates the transaction path used by the operation for which the error is logged and it is qualified by the *pv* bit. The *path-id* field is valid when *pv=1*.

The *source* field is the fixed address of the source module of the operation. In a cache-coherent operation, a cache-coherent module may respond, rather than the addressed system responder module. It is the fixed address of this third party module which becomes the source address of the operation. Logging of the source address is optional; the *sv* bit qualifies the *source* field.

### Floating-Point Coprocessor State

The floating-point coprocessor state is returned in the following format:

0x00000158		344
	FPR 0	
0x00000160		352
	FPR 1	
0x00000168		360
	.	
	.	
	.	
0x00000250		592
	FPR 31	
0x00000258		600

If software wants the address of these registers in memory to occur at doubleword-aligned boundaries, it must adjust the word-aligned *memaddr* parameter in the PDC\_PIM procedure to be doubleword aligned.

## PDC\_POW\_FAIL (index 1)

**Purpose:** To perform whatever HVERSION dependent steps are necessary to prepare the system for powerfail.

Arguments:	Description	ARG1
	Prepare for powerfail	0

Status:	Value	Description
	3	Call completed with a warning. An error of unspecified type occurred, but the call completed correctly. OPTIONAL. The procedure need not report warning conditions.
	0	OK The call completed normally and the procedure detected no error. No powerfail warning is in effect. REQUIRED.
	-2	Nonexistent option ARG1 did not correspond to an option provided by the procedure. REQUIRED.
	-3	Cannot complete call without error An error of unspecified type prevented the call from completing correctly. CONDITIONAL. Must be used if indeterminate errors can be detected.
	-10	Invalid argument An argument other than ARG0 or ARG1 was invalid. OPTIONAL. The procedure need not check arguments for correctness.

**Description:** This procedure is called by the operating system when it receives a power failure interrupt and after it completes its own powerfail preparation. PDC\_POW\_FAIL does whatever HVERSION-dependent preparation is necessary and then waits idly until primary power fails. In the idle state, the procedure must not generate any bus transactions.

If no powerfail warning is in effect at the time of the call, the PDC\_POW\_FAIL procedure returns to the caller.

The "**Prepare for powerfail**" option (ARG1=0) checks the BUS\_POW\_WARN signal on the central bus. If BUS\_POW\_WARN is asserted, PDC\_POW\_FAIL prepares the system for the loss of primary power. After preparation is completed, it enters an idle loop. If BUS\_POW\_WARN is not asserted, PDC\_POW\_FAIL simply returns to its caller.

The stack space available for use by PDC\_POW\_FAIL is 512 bytes of memory, in contrast to the 7 Kbytes available for other PDC and IODC procedures.

The existence of the PDC\_POW\_FAIL procedure is HVERSION dependent. Processors in systems which support powerfail recovery must provide this procedure; processors in systems which do not support powerfail recovery must not provide this procedure.

## PDC\_PROC (index 16)

**Purpose:** To stop or rendezvous the currently executing processor in a multiprocessor system.

<b>Arguments:</b>	Description	ARG1	ARG2	ARG3	ARG4	ARG5	ARG6	ARG7
	Stop processor	0	R	R	R	R	R	R
	Rendezvous processor	1	R	R	R	R	R	R

<b>Status:</b>	Value	Description
	3	Call completed with a warning. An error of unspecified type occurred, but the call completed correctly. OPTIONAL. The procedure need not report warning conditions.
	-2	Nonexistent option ARG1 did not correspond to an option provided by the procedure. REQUIRED.
	-3	Cannot complete call without error An error of unspecified type prevented the call from completing correctly. CONDITIONAL. Must be used if indeterminate errors can be detected.
	-10	Invalid argument An argument other than ARG0 or ARG1 was invalid. OPTIONAL. The procedure need not check arguments for correctness.
	-12	Assertion of BUS_POW_WARN signal detected CONDITIONAL. Must be used if the procedure cannot satisfy the powerfail budget.

**Description:** The "**Stop processor**" option (ARG1=0) causes the processor currently executing to stop. Bus requestorship is disabled, the PSW I-bit is 0, and the module no longer participates in cache coherence protocols. It is the callers responsibility to ensure that any required data is flushed from the cache prior to calling the Stop Processor option.

The "**Rendezvous processor**" option (ARG1=1) causes the processor currently executing to enter the PDCE\_RESET rendezvous code. The processor must meet all the boundary conditions specified in the OS\_RENDEZ interface and in the PDCE\_RESET definition for a rendezvousing processor. This option must be implemented by category B (multiprocessor) processor modules, and is HVERSION dependent for category A (uniprocessor) modules.

## PDC\_PSW (index 21)

**Purpose:** To manage the default value of configurable PSW bits for a processor.

Arguments:	Description	ARG1	ARG2	ARG3	ARG4
	Return Mask	0	R_addr	R	R
	Return Defaults	1	R_addr	R	R
	Set Defaults	2	state	R	R

Returns:	Description	RET[0]
	Return Mask	mask
	Return Defaults	defaults
	Set Defaults	--

Status:	Value	Description
	3	Call completed with a warning. An error of unspecified type occurred, but the call completed correctly. OPTIONAL. The procedure need not report warning conditions.
	0	OK The call completed normally and the procedure detected no error. REQUIRED.
	-2	Nonexistent option ARG1 did not correspond to an option provided by the procedure. REQUIRED.
	-3	Cannot complete call without error An error of unspecified type prevented the call from completing correctly. CONDITIONAL. Must be used if indeterminate errors can be detected.
	-10	Invalid argument An argument other than ARG0 or ARG1 was invalid. OPTIONAL. The procedure need not check arguments for correctness.
	-12	Assertion of BUS_POW_WARN signal detected CONDITIONAL. Must be used if the procedure cannot satisfy the powerfail budget.

**Description:** The "**Return Mask**" option (ARG1=0) returns, in *mask*, a mask indicating which default PSW bits are implemented by the processor. The format of *mask* is:

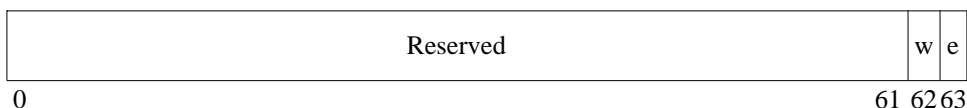

Each bit in *mask* which is 1 indicates that the corresponding default PSW bit is implemented; those which are 0 indicate bits which are not implemented.

The "**Return Defaults**" option (ARG1=1) returns the current default PSW values of the processor in *defaults*. The format of *defaults* is the same as that described above for *mask*. The *w* field indicates the default width of the processor. The *w* field also determines whether the External Interrupt Request (EIR) register is treated as a right-justified 32-bit register or a full 64-bit register. The *e* field indicates the default endianness of the processor. Both bits determine how the PSW W-bit and E-bit will be set on an interruption. Only those bits whose *mask* value (from the "**Return Mask**" option) is 1 are valid.

The "**Set Defaults**" option (ARG1=2) sets the default PSW values of the processor to the value specified in *state*. The format of *state* is the same as that described above for *mask*. Only those bits whose *mask* value (from the "**Return Mask**" option) is 1 will be affected.

The default PSW values are per-processor resources and must be maintained as non-volatile state.



## PDC\_SCSI\_PARMS (index 26)

**Purpose:** To store SCSI Initialization parameters in and retrieve from system NVRAM.

**Options:** Both options are required for all processors.

Arguments:	Description	ARG1	ARG2	ARG3	ARG4	ARG5	ARG6	ARG7
	Get SCSI Parms	0	R_addr	modaddr	R	R	R	R
	Set SCSI Parms	1	R_addr	modaddr	SCSI_ID	Xfer	Bwidth	Autoterm

Returns:	Description	RET[0]	RET[1]	RET[2]	RET[3]	RET[4]
	Get SCSI Parms	SCSI_ID	Xfer	Bwidth	Autoterm	Physloc
	Set SCSI Parms	Physloc	R	R	R	R

Status:	Value	Description
	2	WARNING. Database entry uninitialized or invalid; default values returned. REQUIRED.
	1	WARNING. Invalid Physical Location detected, if Get SCSI Parms, defaults are returned. REQUIRED.
	0	OK The call completed normally and the procedure detected no error. REQUIRED.
	-2	Nonexistent option ARG1 did not correspond to an option provided by the procedure. REQUIRED.
	-3	Cannot complete call without error An error of unspecified type prevented the call from completing correctly. CONDITIONAL. Must be used if indeterminate errors can be detected.
	-10	Invalid argument An argument other than ARG0 or ARG1 was invalid. OPTIONAL. The procedure need not check arguments for correctness.
	-12	Assertion of BUS_POW_WARN signal detected CONDITIONAL. Must be used if the procedure cannot satisfy the powerfail budget.
	-15	Table overflow trying to update scsi parms. REQUIRED.

**Description:** The "Get SCSI Parms" option (ARG1=0) obtains the SCSI parms associated with the I/O device at the module path in the structure pointed to by the *modaddr* input argument from system NVRAM.

RET[0], *SCSI\_ID* is the SCSI initiator ID of the SCSI controller on the I/O card to which the request is made. *SCSI\_ID* must be an integer in the range 0..15. The default value is 7.

RET[1], *Xfer*, is the maximum transfer rate (in mega-transfers per second) on the SCSI bus. The valid transfer rates depend on the particular SCSI controller, and are contained in the IODC ERS for the particular platform on which the I/O card or cards are used. In any case, the parameter is an integer. The value 0 indicates that the caller is to use the maximum rate that the SCSI controller is capable of, except on Ultra SCSI controllers (which are maximally capable of 20 mega-transfers per second) where it means 10 mega-transfers per second. The default value is I/O card dependent.

RET[2], *Bwidth*, indicates the width of the SCSI bus connected to the SCSI port on the adapter on the card. This parameter is an unsigned integer, and valid values are 8 or 16, depending on the width of the bus on the card. The value 0 indicates to use the bus width that the SCSI controller is capable of. The default value is I/O card dependent.

RET[3], *Autoterm* indicates whether the autotermination feature of the I/O card is enabled or disabled. This parm is an integer. A value of 1 indicates that autotermination is enabled. A value of 0 indicates that autotermination is disabled. A value of 2 indicates that the autotermination setting is unknown. The default is "unknown."

RET[4], *Physloc* is the Physical Location of the I/O card. It is an 8-byte formatted quantity in Physical Location format. See Section 1.2.3 of the PDC PAT ARS, Version 2.5 or later, for the format of this field. This value is stored in NVRAM to determine if the cell card or I/O chassis has been moved. It is also calculated by this procedure. If the calculated value is not the same as the value stored in NVRAM, a correct value will be returned for this parm, default values will be returned for all the other parms, and a Return Status of 1 will be returned to indicate that an invalid Physical Location was found (the cell card was moved), and that default values for the parms were returned.

When this procedure is called to return the SCSI parms, it should check whether the data area in NVRAM is initialized or not. If the data area is uninitialized, it should return default values for RET[0] through RET[3], should calculate a value of RET[4], and should return a Return Status of 2 indicating defaults are being used.

Finally, when storing SCSI parameters in system NVRAM, PDC should also store the serial number of the system internally as a cross check to determine when cell have been moved between systems. This value should be checked by the Get option.

---

**NOTE**

PDC\_SCSI\_PARMS, IODC ENTRY\_CONFIG[**Get SCSI Parms** and **Set SCSI Parms**] are architected firmware interfaces to replace the Hversion PDC\_INITIATOR procedure. The purpose of these procedures is to provide additional flexibility in assigning SCSI Initiator IDs to multiple SCSI controllers, and to allow offline replacement, addition and swapping of both cell cards and I/O cards without impacting system operation. This includes swapping cards within a complex and also between complex. It also includes the ability to detect swapping I/O chassis cables or cabinets. It also is intended to allow swapping of either cell card or I/O card (but not both) without user intervention at the console to reinitialize.

For this reason, there are a number of programming requirements on software which uses these procedures. First, software may assume that if either option of either PDC\_SCSI\_PARMS or IODC ENTRY\_CONFIG[**Get SCSI Parms** or **Set SCSI Parms**] is present, then all are present. However, it may not require their presence for correct operation. For this reason, software should always try to use these procedures first, then if they are not implemented, it should try to use PDC\_INITIATOR. Finally if that is also not available, then it should proceed without firmware support.

Next, when software uses these procedures, it is important to follow the correct programming model to ensure that card swaps are correctly detected. Whenever the SCSI parms are stored, they must be stored to both card NVRAM and system NVRAM by using both the PDC and IODC interfaces. This allows a consistent image to be stored with internal consistency check in both PDC and IODC to ensure correctness.

When the parms are retrieved, they should also be retrieved from both IODC and PDC storage. If either the PDC or IODC data area is uninitialized (new card) or if the card has been swapped, PDC or IODC will return default values, and will return a Return Status indicating that defaults are being returned. IODC will also return the Physical Location stored on the card. If this is not the actual correct physical location, software knows that the card has been swapped between I/O slots, and should not rely on the card for correct information.

Software should check that all the data returned from both PDC and IODC are consistent. If it is not, or if default values were returned from either, software should

reinitialize both PDC and IODC NVRAM to the correct values.

After a simultaneous offline cell and associated I/O card replacement the I/O card's parameters will revert to the default values. In this case, to avoid incorrect operation, the user must re-setup the parameter values for the replacement I/O card (in BCH or online) if values other than the defaults are needed. Similarly, after an offline cell replacement any associated I/O cards without NVRAM will need to have their parameter values re-setup if values other than defaults are needed.

The following pseudo code shows expected driver behavior for SCSI card initialization:

```

call PDC_SCSI_PARMS ("get" option);
if (PDC_SCSI_PARMS is implemented) {
  Read card NVRAM (parms, Physloc, saved system serial number).
  Read system serial number (by calling PDC_MODEL) for use
  below when (re)initializing card NVRAM.
  if (PDC NVRAM contains valid, initialized values)
    /* PDC_SCSI_PARMS status return == 0 */
    {
      if (card NVRAM contains valid, initialized values) {
        Error the driver initialization if PDC values != card
        values (after translating PDC value 0 for Xfer or Bwidth
        to the corresponding SCSI value), to indicate that the
        user needs to set the parameters in BCH or online;
        else use the card values to initialize the card.
      }
      else {
        Use the PDC values to initialize the card and to
        re-initialize card NVRAM.
      }
    }
  else {
    if (card NVRAM contains valid, initialized values)
      /* card NVRAM contains initialized values with correct
      system serial number and correct physical location */
      {
        Use the values in card NVRAM to initialize the card;
        and re-initialize the PDC values using card NVRAM
        values (ie. call PDC_SCSI_PARMS "set" option).
      }
    else {
      /* There are no valid, initialized values. */
      /* Either (1) this is a new install of a new system, or
      (2) a simultaneous offline cell and associated I/O card
      replacement occurred, or (3) an offline cell replacement
      occurred and an associated I/O card has no NVRAM, or (4)
      a card addition into a slot that hasn't previously been
      initialized or whose parameters have been
      deleted/invalidated has occurred. */
      Log a warning message (to the chassis log, with severity 1,
      if in the IODC driver) containing the Physical Location and
      indicating that both PDH and card NVRAM values are
      uninitialized or invalid and that default values are being
      used. This is important to leave a trail of what occurred in
      case of improper operation due to user forgetfulness across
      the cases listed above.

      Use the default values to initialize the card, and
      to initialize both PDC and card NVRAM.
    }
  }
}
else {
  Do the old algorithm using PDC_INITIATOR
}

```

---

The "**Set SCSI Parms**" option (ARG1=1) stores the SCSI parms associated with the I/O device at the module path in the structure pointed to by the *modaddr* input argument in system NVRAM.

The parms stored are ARG4 through ARG7. These are the same variables as are returned in RET[0] through RET[3] of **Get SCSI Parms**.

For each parm being stored, a value of -2 in the corresponding input argument means do not change the parm, a value of -1 in the input argument means to set the parm to it's default value.

ARG4, *SCSI\_ID*, is the SCSI initiator ID of the SCSI controller. This input argument is a signed integer. Valid values are 0 through 15, or -2 indicating don't change, or -1 indicating use the default. The default is 7.

ARG5, *Xfer*, is the maximum transfer rate on the SCSI bus. Units are mega-transfers per second. This argument is a signed integer. Valid values for Xfer depend on the SCSI protocol being used, and are given in the PDC ERS for each individual platform. The input argument must either be a valid value, -2 indicating don't change, or 0 whose meaning is defined in the Get SCSI Parms description. The default is I/O card dependent.

ARG6, *Bwidth* is the width of the SCSI bus on the card. *Bwidth* is a signed integer. Valid values for this argument are 8, 16 which are valid *Bwidth* values, -2, indicating don't change *Bwidth*, or 0 whose meaning is defined in the Get SCSI Parms description. The default is I/O card dependent.

ARG7, *Autoterm* is the indicator of whether autotermination should be enabled or disabled. Autoterm is a signed integer. Valid values for this argument are 0, indicating to disable autotermination, 1, indicating to enable autotermination, or -1 to indicate that the default value of the autotermination indicator should be used, or -2, to indicate not to change the autotermination indicator. The default value is "enabled."

---

**PROGRAMMING NOTE**

The *Autoterm* value often needs to be set on workstation platforms, and disabled on servers and other HA platforms. If *Autoterm* needs to be disabled, the correct value should be set at BCH or during the manufacturing process.

---

**PROGRAMMING NOTE**

Both the *Xfer* and *Bwidth* values are I/O card dependent. Before calling the procedure to set SCSI parms in system NVRAM, the caller should get the correct values from the driver. Default values are not allowed.

---

This procedure is called to Set the SCSI parms in system NVRAM to mirror the values set by IODC ENTRY\_CONFIG[Set SCSI Parms] in NVRAM on the I/O card. This shadowing allows software to detect changes when either cell cards are swapped or I/O cards are swapped offline. Note that although not input as an argument, the Physical location of the card is calculated and stored in NVRAM, and is returned by **Get SCSI Parms**. Whenever the SCSI parms are updated, the Physical Location currently stored is checked against the actual Physical Location of the I/O card. If they are not consistent, a Return Status of 1 is returned to let the caller know the card has been moved. Note that this PDC\_PROCEDURE accesses system NVRAM only and does not access the I/O card in any way. Finally, setting all input arguments ARG3 through ARG6 to -2 (meaning don't change), results in the system NVRAM being reinitialized to being an invalid entry without any parms stored.

See the programming note above in **Get SCSI Parms**, which defines the programming model that is expected to be used with these calls.

---

**PROGRAMMING NOTE**

The firmware console manager (BCH) should allow PDC\_SCSI\_PARAMS to set values for slots which do not have scsi cards in the slot. This will allow for future expansion without having to reprogram the slot configuration information.

---

## PDC\_SOFT\_POWER (index 23)

**Purpose:** To allow software control of the power off feature.

Arguments:	Description	ARG1	ARG2	ARG3
	Return Information	0	R_addr	R
	Enable/Disable Soft Power	1	R_addr	Power_control

Returns:	Description	RET[0]	RET[1]	RET[2]
	Return Information	Poll_addr	shft_amt	R
	Enable/Disable Soft Power	R	R	R

Status:	Value	Description
	3	Call completed with a warning. An error of unspecified type occurred, but the call completed correctly. OPTIONAL. The procedure need not report warning conditions.
	0	OK The call completed normally and the procedure detected no error. REQUIRED.
	-2	Nonexistent option ARG1 did not correspond to an option provided by the procedure. REQUIRED.
	-3	Cannot complete call without error An error of unspecified type prevented the call from completing correctly. CONDITIONAL. Must be used if indeterminate errors can be detected.
	-10	Invalid argument An argument other than ARG0 or ARG1 was invalid. OPTIONAL. The procedure need not check arguments for correctness.
	-12	Assertion of BUS_POW_WARN signal detected CONDITIONAL. Must be used if the procedure cannot satisfy the powerfail budget.

**Description:** The "**Return Information**" option (ARG1=0) returns the location of the Soft Power Register, which may be read to determine the current power switch setting. The address is returned in *poll\_addr*, which is a 64-bit physical address. This location may be read, in turn, to determine the power switch setting.

The **shft\_amt** return parameter determines the layout of the Soft Power Register. The Soft Power Register is read and shifted right by **shft\_amt** then anded with the value 1. If the result is 0, then soft power is disabled and power is under control of the hardware. If the result is 1, then soft power is enabled. In this case, toggling the front panel switch does not immediately turn off power, but initiates the OS power-down sequence. **shft\_amt** must be an unsigned integer in the range 0:63.

The Soft Power Register is a 64-bit register with one operational bit as described above.

The "**Enable/Disable Soft Power**" option (ARG1=1) allows the OS to enable or disable software control of the power off feature. At power on and reset the feature is disabled. That is, power is under hardware control. When "**Enable/Disable Soft Power**" is called with *Power\_control* (ARG3) set to  $2^{\text{shft\_amt}}$ , (bit  $63-\text{shft\_amt}$  set), then soft power is enabled.

---

### ENGINEERING NOTE

For implementations which use a LED to indicate the Soft Power feature, Calling "**Enable/Disable Soft Power**" with *Power\_control* set to one causes the LED to go from flashing mode to solid on mode.

---

When "**Enable/Disable Soft Power**" is called with *Power\_control* set to zero, the power switch

is placed under direct hardware control. If the hardware switch is in the off position, the system is immediately powered off. If the switch is in the on position, software control is disabled, and the PDC call returns to the OS.

---

### ENGINEERING NOTE

For implementations which use a LED to indicated the Soft Power feature, Calling "**Enable/Disable Soft Power**" with Power\_control set to zero when the power switch is in the on position causes the LED to go from solid on mode to flashing mode.

---

## PDC\_STABLE (index 10)

**Purpose:** To provide access to Stable Storage.

Arguments:	Description	ARG1	ARG2	ARG3	ARG4
	Read data	0	staddr	memaddr	count
	Write data	1	staddr	memaddr	count
	Return size	2	R_addr	HV	---
	Verify contents	3	HV	HV	---
	Initialize	4	HV	HV	---

Returns:	Description	RET[0]
	Read data	---
	Write data	---
	Return size	size
	Verify contents	---
	Initialize	---

Status:	Value	Description
	3	Call completed with a warning. An error of unspecified type occurred, but the call completed correctly. OPTIONAL. The procedure need not report warning conditions.
	1	Correctable error The call completed normally and the returned results are valid. The procedure encountered an error which it was able to correct completely. Returned only by options ARG1=0, 1, 3, and 4. CONDITIONAL. Must be used if PDC_STABLE performs error recovery.
	0	OK The call completed normally and the procedure detected no error. REQUIRED.
	-2	Nonexistent option ARG1 did not correspond to an option provided by the procedure. REQUIRED.
	-3	Cannot complete call without error An error of unspecified type prevented the call from completing correctly. CONDITIONAL. Must be used if indeterminate errors can be detected.
	-5	Invalid Stable Storage contents Returned only by options ARG1=0, 1, 3, and 4. REQUIRED.
	-10	Invalid argument An argument other than ARG0 or ARG1 was invalid. CONDITIONAL. Must be returned by ARG1=0 or 1 if $staddr+count > size$ . Otherwise, the procedure need not check arguments for correctness.
	-12	Assertion of BUS_POW_WARN signal detected CONDITIONAL. Must be used if the procedure cannot satisfy the powerfail budget.

**Description:** **Stable Storage** is used to maintain system parameters during power outages. It is required to retain its contents even if the card containing it is removed from the backplane. Stable Storage is used during boot. It contains the paths to the console and boot devices.

Stable Storage is a system-wide resource shared by all processors in a multiprocessor system. Software must ensure that at most one call to PDC\_STABLE is in progress at any one time.

The integrity of the storage must be guaranteed. Reliability must be such that an undetected error will occur only once in the lifetime of a million machines.



Stable Storage must have a minimum lifetime of 10,000 write cycles.

The "**Read data**" option (ARG1=0) transfers *count* bytes from Stable Storage address *staddr* to memory address *memaddr*. *count* is an unsigned 64-bit integer which is a multiple of four. *staddr* and *memaddr* must be word aligned. The call must return -10 if  $staddr+count > size$ .

Reads must validate data integrity for the bytes being read. If a checksum algorithm is used, this may involve validating all of Stable Storage. If the data integrity check fails, the call must return -5 and (if possible) the potentially bad data.

The "**Write data**" option (ARG1=1) transfers *count* bytes from memory address *memaddr* to Stable Storage address *staddr*. *count* is an unsigned 64-bit integer which is a multiple of four. *staddr* and *memaddr* must be word aligned. The call must return -10 if  $staddr+count > size$ .

Writes must not mask errors in Stable Storage. Before a write is attempted, PDC\_STABLE must check the data integrity of the words being modified. If the check fails, PDC\_STABLE must not attempt to write any data: instead, it must return -5. If the check succeeds, the write can proceed. After the data is written, PDC\_STABLE must also verify that the write took place correctly. If the write did not succeed, -3 must be returned.

If a write to Stable Storage is interrupted due to a powerfail, reset, or TOC, and if PDC cannot guarantee that the write completed, then it must ensure that data integrity checks fail on subsequent accesses to Stable Storage.

---

#### ENGINEERING NOTE

A recommended method to check the validity of Stable Storage is to include a checksum in a non-architected tertiary state storage area. This checksum should be designed such that a Stable Storage filled with all zeroes or all ones will not generate a valid checksum.

If a write to Stable Storage is interrupted by a powerfail, reset, or TOC, hardware implementations should attempt to limit the extent of damage to the words that were being modified. This rule applies except for genuine hardware failures or sudden power failures. For such failures, the extent of damage cannot be predicted.

---

The "**Return size**" option (ARG1=2) returns the number of bytes in the processor's Stable Storage. *size* is the number of contiguous bytes implemented in Stable Storage starting from *staddr*=0. *size* is an unsigned 64-bit integer which is a multiple of four.

The "**Verify contents**" option (ARG1=3) verifies that the Stable Storage contents are valid.

The "**Initialize**" option (ARG1=4) sets the architected contents of Stable Storage to zero and initializes the validity indicator. Unarchitected areas in stable storage must be cleared individually.

---

**PROGRAMMING NOTE**

An algorithm to restore Stable Storage in the event of a failure follows:

1. Copy out the entire contents of Stable Storage into memory.
2. Fix all the bad values by correcting the copied values in memory.
3. Call the "Initialize" option to zero Stable Storage.
4. Write the good copy from memory to Stable Storage.
5. Call the "Verify contents" option to check for successful completion.

To protect against a powerfail after the "Initialize" option has zeroed Stable Storage, but before the new values are written back, software should back up the contents on disk before zeroing, or be able to reconstruct Stable Storage from the all zero state.

---

---

**ENGINEERING NOTE**

Specific products may choose to implement multiple copies of Stable Storage to increase the fault tolerance of the system, but this must be transparent to the callers of PDC\_STABLE.

---

## Data Format of Stable Storage

The format of Stable Storage is as follows:

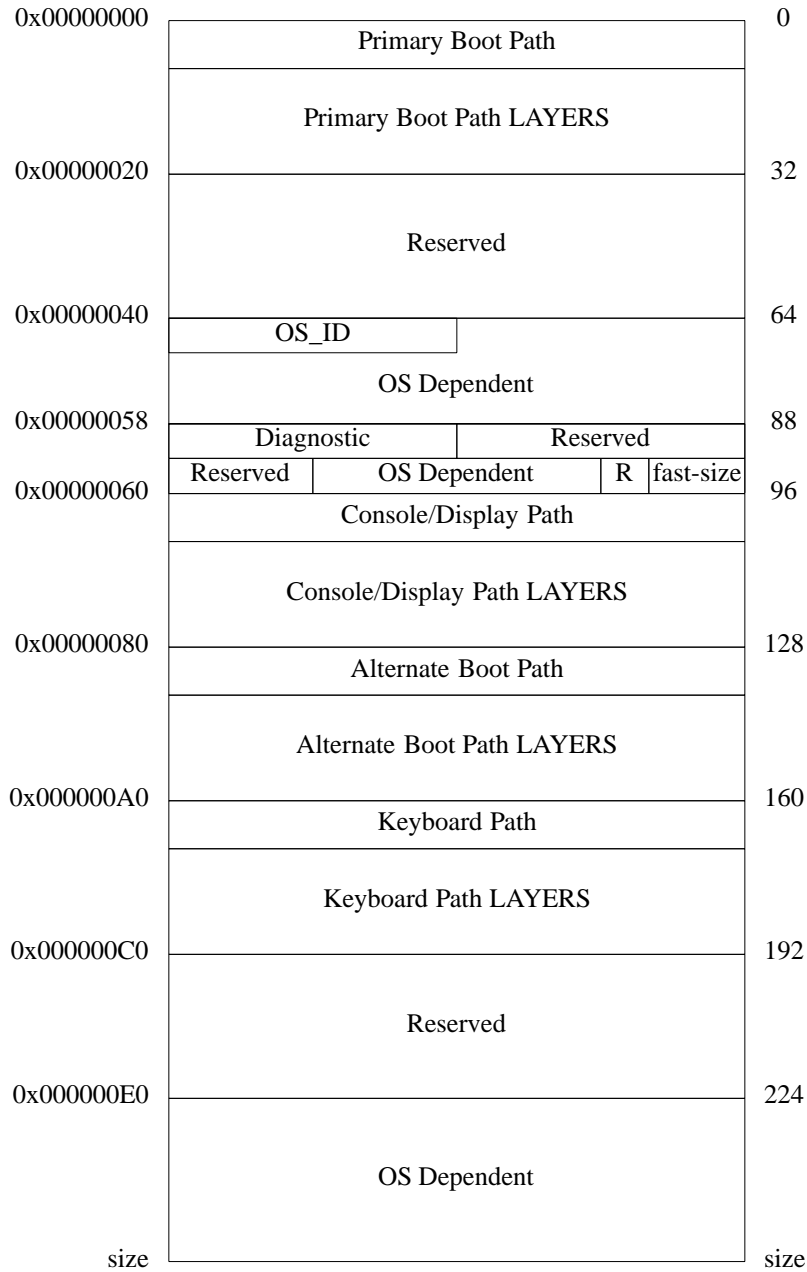

A minimum of 96 bytes of Stable Storage is required. Providing more than 96 bytes of Stable Storage is optional, but it must be used in the architected way if provided. Failure to provide the optional locations from 96 to 192 results in the loss of certain functionality during boot. (For example, ISL would not be able to set the console path.)

## Primary Boot Path

The format of the Primary Boot Path is as follows:

0x00	flags	BC(0)	BC(1)	BC(2)	0
0x04	BC(3)	BC(4)	BC(5)	MOD	4
0x08	LAYER_1				8
0x0C	LAYER_2				12
0x10	LAYER_3				16
0x14	LAYER_4				20
0x18	LAYER_5				24
0x1C	LAYER_6				28
0x20					32

The format of *flags* is as follows:

ab	as	R	timer
0	1	2	3 4 7

The autoboot and autosearch bits, *ab* and *as* respectively, select the mechanism used to locate the boot device. The *timer* field is used by PDC to initialize the value of its boot timer. If *timer* is 0, PDC initializes the boot timer to an HVERSION-dependent default value. Otherwise, PDC initializes its boot timer to  $2^{\text{timer}}$  seconds.

The values of BC(0) through BC(5) specify the bus converter routing to the specified boot module. Values of 0 through 63 specify the fixed field of the bus converter port's HPA. The values 64-127 are reserved. The values 128-255 are null values, and are ignored in the path specification.

If only N bus converters are specified in the path to the specified boot module, the leading bytes of the path specifier, BC(0) through BC(5-N), are null. In that case, BC(6-N) specifies the routing through the bus converter closest to the processor.

The value of MOD is the fixed field of the specified module. The values 64-127 are reserved. The values 128-255 are null values, and indicate that the path has not been specified.

The six-word LAYERS block is used to describe the portion of the path to a device that is beyond the module and/or to contain device-dependent information. The path specification is based on a model that assumes a set of layers beyond the module. A layer is defined as a series of entities which are separately addressable and exist at the same level in a hierarchical tree structure.

Two types of entity make up the tree structure in the layers beyond the module. **Devices** form the leaves in the tree structure. **Controllers** form the intermediate entities between the module and devices.

---

### ENGINEERING NOTE

For example, an HP-CIO Adapter always has layers beyond the module. The first layer contains the device adapters on the CIO bus. If that device adapter is an HPIB adapter, the next layer might include a disk controller on the HPIB bus.

---

Each entity within a layer is identified by a 32-bit number. That number should have some physical

correspondence to the address of the entity within the layer. The number should be easy for the operator to associate with the entity, for example, via switch positions.

If there are N layers beyond the module, the words LAYER\_1 through LAYER\_N specify the addresses of entities in those layers, in order, starting with the layer closest to the module. There can be a maximum of six layers beyond the module. If there are less than six layers beyond the module, the words after the ones used for layers are device dependent. There is no delimiter to mark the end of the layers and the start of the device-dependent words. It is expected that the boundary will be implicitly understood by the routines that are using the path. If there are no layers beyond the module, all six words are device dependent.

## OS Dependent

There are three OS Dependent fields in Stable Storage. The first field is 24 bytes and is located at 0x40. The second field is two bytes and is located at 0x5D. The third field is at 0xE0 and occupies the rest of Stable Storage up to the *size* value returned by the "Return Size" option.

The first halfword of the first OS Dependent area (at 0x40) is used to store an identifier called OS\_ID. OS-dependent use of Stable Storage and Non-Volatile Memory is qualified by OS\_ID.

Values of OS\_ID are assigned by Hewlett-Packard's System Architecture and Design Laboratory. The following values of OS\_ID are defined:

0x0000	No OS-dependent data
0x0001	HP-UX dependent data
0x0002	MPE-iX dependent data
0x0003	OSF dependent data
0x0004	HP-RT dependent data
0x0005	Novell Netware dependent data

Other values are reserved.

Data read from either of the OS-dependent areas of Stable Storage or the OS Panic Information area of Non-Volatile Memory must be interpreted in the context of the value of OS\_ID.

The operating system should ensure that the value of OS\_ID is appropriate and that the OS-dependent areas are initialized to proper default values.

The format of the second OS dependent area (at 0x5D) and the third OS dependent area (at 0xE0) depends on OS\_ID.

## Fast-size

Byte 0x5F is defined as follows:

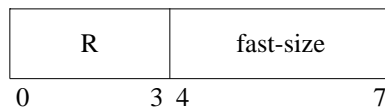

where *fast-size* specifies the amount of memory that PDCE\_RESET initializes and tests, as follows:

<i>fast-size</i>	Memory Tested
0	256 KB
1	512 KB
2	1 MB
3	2 MB
4	4 MB
5	8 MB
6	16 MB
7	32 MB
8	64 MB
9	128 MB
A	256 MB
B	512 MB
C	1 GB
D	2 GB
E	all
F	all

Values of *fast-size* other than 'E' or 'F' specify the amount of contiguous memory to be tested; in these cases, if the amount of contiguous memory on the local bus is less than the amount specified by *fast-size*, all contiguous memory is tested and no error is indicated. The memory need not be interleaved.

When a memory module's SPA is larger than *fast-size*, PDCE\_RESET must configure the memory module, but must only initialize and test up to *fast-size*. That is, any transactions beyond *fast-size*, but within the memory's SPA must be slave acknowledged.

The values 'E' and 'F' allow all local memory, contiguous or noncontiguous, to be tested by PDC.

### **Console/Display Path, Alternate Boot Path, and Keyboard Path**

Except for the *flags* field, the format of the Console/Display, Alternate Boot, and Keyboard Path areas are the same as defined for the Primary Boot Path. The *flags* field for the Console/Display Path contains a *timer* field the same as the Primary Boot Path, but not the *ab* or *as* bits. The *flags* field in the Alternate Boot Path and Keyboard Path is reserved.

---

#### **ENGINEERING NOTE**

Stable Storage, which can be modified by software, must have an initial value when shipped from the factory. Each processor design group is responsible for defining initial Stable Storage values for that processor. In the absence of more specific information, all bytes in Stable Storage should be initialized to 0, except bytes 0x07, 0x67, 0x87, 0xA7 which should be set to 0xFF (path not specified) and byte 0x5F which should be set to 0x0F (*fast-size* = all).

---

## PDC\_SYSTEM\_MAP (index 22)

**Purpose:** To locate and identify modules in a system which reside at fixed I/O addresses, and which do not self identify.

Description	ARG1	ARG2	ARG3	ARG4
Find Module	0	R_addr	mod_path	mod_index
Find Address	1	R_addr	mod_index	addr_index
Translate Path	2	R_addr	mod_path	R

Description	ARG5	ARG6	ARG7
Find Module	R	R	R
Find Address	R	R	R
Translate Path	R	R	R

Description	RET[0]	RET[1]	RET[2]	RET[3]
Find Module	mod_addr	mod_pgs	add_addrs	
Find Address	mod_addr	mod_pgs		
Translate Path	mod_addr	mod_pgs	add_addrs	mod_index

Value	Description
0	OK. The call completed normally and the procedure detected no error. REQUIRED
-2	Non-existent option. ARG1 did not correspond to an option provided by the procedure. REQUIRED.
-3	Cannot complete call without error. An error of unspecified type prevented the call from completing normally. CONDITIONAL. Must be used if indeterminate errors can be detected.
-5	Module not found. No module exists which corresponds to the LAYER structure or module index specified. REQUIRED.
-6	Address range not found. No address range exists which corresponds to the address index specified. REQUIRED. Returned only by option ARG1=1.
-10	Invalid Argument An argument other than ARG0 or ARG1 was invalid OPTIONAL. The procedure need not check arguments for correctness.
-12	Assertion of BUS_POW_WARN detected. CONDITIONAL. Must be used if the procedure cannot satisfy the powerfail budget.

**Description:** The PDC\_SYSTEM\_MAP procedure is called by the operating system when it is configuring the IO system immediately after a boot. It is used to locate and identify modules which can not provide IODC.

"Find Module" returns information about the fixed address module indexed by 'mod\_index.' Fixed address modules are indexed from 0 to N-1, where N is the number of fixed address modules in a system. Upon entry to "Find Module" 'mod\_path' (ARG3) contains a pointer to a LAYER structure (see PDC\_STABLE), but the LAYER structure need not be initialized to any particular value. If the option finds a fixed address module, it returns the first page of the first address range in address range in 'mod\_pgs' (RET[1]). In addition, it places the physical path of the module in the LAYER structure pointed to by 'mod\_path' (ARG3). If the module contains multiple discontinuous address ranges, a non-zero number is returned in 'add\_addrs' (RET[2]) which is the number of additional address ranges. The value returned in 'mod\_addr' is the address passed to PDC\_IODC to get module type and version information. If there are no fixed

address modules at index -5.

"Find Address" returns information about subsequent address ranges for modules with multiple address ranges. Upon entry to "Find Address" 'mod\_index' contains the value used in the Address." 'addr\_index' contains the index of the address range for which information is requested. If the option finds an address range corresponding to that module and address index, the address of the first page is returned in 'mod\_addr' (RET[0]), and the number of pages in the address range is returned in -5. If there is no address range corresponding to 'addr\_index', "Find Address" will return with a status value of -6.

The "Translate Path" option returns module information for the module whose path is described by the LAYER structure pointed to by 'mod\_path' (ARG3). The values returned in RET[0] through RET[2] are exactly as described in "Find Module". In addition "Translate Path" returns the module index of the module in 'mod\_index'. For modules with multiple discontinuous address ranges, this can be used with "Find Address." If the path in the LAYER structure does not correspond to an actual module, "Translate Path" returns with a status of -5.

---

### PROGRAMMING NOTE

The following code describes a high level OS algorithm which could use this PDC procedure on any existing (9000/700, 9000/800, 3000/900) platform or currently planned future platforms.

```
Find monarch processor and memory controller;
If (processor.HVERSION is Snakes) { /* cannot use PDC call existence */
    Find fixed devices using PDC_MEMORY_MAP; /* because of Emerald conflicts */
};
Else { /* we're either on a new system or old s800 or s900 */
    module_index = 0;
    if (status(PDC_SYSTEM_MAP("Find Module",module_index))!=-1) {
        /* we are on a new system with PDC_SYSTEM_MAP */
        while (status!=-5) {
            Add a new module to IO table;
            if (add_addrs) {
                for (address_index = 1; address_index++; address_index <= add_addrs) {
                    PDC_SYSTEM_MAP("Find Address", address_index);
                    Add a new address range to module;
                };
            };
            module_index++;
            PDC_SYSTEM_MAP("Find Module",module_index)
        } /* continue loop while status != -5 */
    }; /* when we get here either we've found all fixed or we are s8/900 */
    Use old s800 or s900 algorithm to find configurable modules;
};
```

---



## PDC\_TLB (index 19)

**Purpose:** To manage hardware TLB miss handling.

Arguments:	Description	ARG1	ARG2	ARG3	ARG4	ARG5	ARG6	ARG7
	Return Parameters	0	R_addr	R	R	R	R	R
	Set up miss handling	1	R_addr	base_addr	table_size	set_state	R	R

Returns:	Description	RET[0]	RET[1]
	Return Parameters	min_size	max_size
	Set up miss handling	state	R

Status:	Value	Description
	3	Call completed with a warning. An error of unspecified type occurred, but the call completed correctly. OPTIONAL. The procedure need not report warning conditions.
	0	OK The call completed normally and the procedure detected no error. REQUIRED.
	-2	Nonexistent option ARG1 did not correspond to an option provided by the procedure. REQUIRED.
	-3	Cannot complete call without error An error of unspecified type prevented the call from completing correctly. CONDITIONAL. Must be used if indeterminate errors can be detected.
	-10	Invalid argument An argument other than ARG0 or ARG1 was invalid. OPTIONAL. The procedure need not check arguments for correctness.
	-12	Assertion of BUS_POW_WARN signal detected CONDITIONAL. Must be used if the procedure cannot satisfy the powerfail budget.

**Description:** The "**Return Parameters**" option (ARG1=0) returns two parameters that characterize the processor's hardware TLB miss handling.

*min\_size* and *max\_size* are the minimum and maximum sizes, in bytes, of the hardware-visible page table supported by the processor. *min\_size* and *max\_size* are 64-bit unsigned integers. *min\_size* and *max\_size* must be within the range 4096 to  $2^{62}$ , and be a power of two.

The "**Set up miss handling**" option (ARG1=1) sets up hardware TLB miss handling. *base\_addr* specifies the starting physical address of the hardware-visible page table. *table\_size* specifies the size, in bytes, of the hardware-visible page table. *base\_addr* must be *table-size* aligned.

The *set\_state* argument controls the state of hardware TLB miss handling. The format of the *set\_state* argument is the following:

R	cr28	en
0	28 29	30 31

The *en* bit determines whether hardware miss handling is enabled (*en* = 1) or disabled (*en* = 0). All processors must support enabling and disabling of hardware TLB miss handling. The *cr28* field determines how the processor's control register 28 is updated when the hardware miss handler fails to insert a translation and traps to software. The values of the *cr28* field are as follows:

Value	Description
0	Pointer to current page table entry
1	Reserved
2	Value from the next page table entry field of current entry
3	Value from word 3 of the 16-byte line containing the current entry

Support for *cr28* values other than 0 is optional. The *state* return value, which has the same format as *set\_state*, indicates the closest *cr28* value which the hardware supports. Even if the hardware does not support the requested *cr28* value, a call made with *en* = 1 will enable hardware miss handling with the *cr28* value as returned in *state*. In particular, if PDC\_TLB is called with *cr28* = 1, hardware miss handling will be enabled with a *cr28* value of 0, and 0 will be returned in the *cr28* field of *state*.

When called with the *en* bit = 0, the *cr28* field of *set\_state*, and the *base\_addr* and *table\_size* arguments are ignored.

Making a PDC\_TLB call with different values of *base\_addr* and/or *table\_size* than were used in a previous call without first disabling hardware miss handling is allowed.

The results of calling PDC\_TLB become effective immediately upon turning on either of the PSW C or D bits.

---

**PROGRAMMING NOTE**

Because there is no mechanism to read the current values of *base\_addr*, *table\_size*, and *set\_state*, callers need to maintain these values for themselves.

---

## PDC\_TOD (index 9)

**Purpose:** To read, set, and calibrate the Time-Of-Day (TOD) clock.

Arguments:	Description	ARG1	ARG2	ARG3
	Read TOD	0	R_addr	HV
	Set TOD	1	tod_sec	tod_usec
	Calibrate timers	2	R_addr	HV

Returns:	Description	RET[0]	RET[1]	RET[2]	RET[3]
	Read TOD	tod_sec	tod_usec	R	R
	Set TOD	---	---	---	---
	Calibrate timers	calib_0	calib_1	TOD_acc	CR_acc

Status:	Value	Description
	3	Call completed with a warning. An error of unspecified type occurred, but the call completed correctly. OPTIONAL. The procedure need not report warning conditions.
	0	OK The call completed normally and the procedure detected no error. REQUIRED.
	-2	Nonexistent option ARG1 did not correspond to an option provided by the procedure. REQUIRED.
	-3	Cannot complete call without error An error of unspecified type prevented the call from completing correctly. CONDITIONAL. Must be used if indeterminate errors can be detected.
	-10	Invalid argument An argument other than ARG0 or ARG1 was invalid. OPTIONAL. The procedure need not check arguments for correctness.
	-12	Assertion of BUS_POW_WARN signal detected CONDITIONAL. Must be used if the procedure cannot satisfy the powerfail budget.
	-13	Time of day invalid Returned only by option ARG1=0. CONDITIONAL. Must be used if the implementation has a way to tell if the clock is invalid. It is strongly recommended that all implementations which consider it important to have a valid clock provide a mechanism to detect an invalid clock.

**Description:** The Time-Of-Day Clock gives an absolute measure of system time. The TOD clock must be secondary powered and must preserve the system time on a primary powerfail.

The Time-Of-Day Clock is a system-wide resource. Software must guarantee that at most one call to PDC\_TOD is in progress at any one time.

The "**Read TOD**" option (ARG1=0) returns two parameters which specify the elapsed time since 00:00:00 GMT, January 1, 1970. The value of *tod\_sec* is interpreted as a number of seconds, and the value of *tod\_usec* as microseconds. *tod\_usec* is normalized to be less than 1,000,000. Both *tod\_sec* and *tod\_usec* are unsigned 64-bit integers.

"Read TOD" must return 0 for any least significant portion of *tod\_usec* which is not accurate.

The "**Set TOD**" option (ARG1=1) is used to set the TOD clock. The meanings and format of *tod\_sec* and *tod\_usec* are the same as in the "Read TOD" option. Callers must normalize *tod\_usec* to a value less than 1,000,000, and adjust the *tod\_sec* parameter appropriately.

If the caller passes a value of *tod\_usec* greater than or equal to 1,000,000 then the PDC\_TOD procedure can optionally return -10 or set the TOD to an HVERSION-dependent value and return 0.

"Set TOD" may optionally discard any least significant portion of *tod\_usec*.

The "**Calibrate timers**" option (ARG1=2) is used to calibrate the Interval Timer (CR16). It returns *calib\_0* and *calib\_1*, a double-precision floating-point value that gives the frequency of the Interval Timer in megahertz. *calib* form a double-precision (64-bit) floating-point value. The first 32-bits (one sign bit, 11 exponent bits, and 20 most significant bits of the fraction field) are contributed by *calib\_0*, the remaining 32-bits of the fraction field are defined by *calib\_1*. Each of these values are returned in the low order (bits 32:63) bits of their return parameter. The accuracies of the TOD clock and the Interval Timer are specified by *TOD\_acc* and *CR\_acc*, respectively. Both of these parameters are unsigned 64-bit integers representing clock accuracy in parts per billion.

---

**PROGRAMMING NOTE**

It is recommended that software call the "Calibrate timers" option to determine which clock (TOD clock or CR16 Interval Timer) is more accurate. Depending on the relative accuracies of the two clocks and product requirements, the frequency and mechanism of synchronizing the two clocks can be determined.

---

A worst case resolution of 1 sec for TOD is required. There is no guarantee that the *tod\_usec* parameter is significant for either the "Read TOD" or "Set TOD" options.

There is no limit on the duration of a PDC\_TOD call.

The "Read TOD" option must adjust the time returned from the TOD clock if the time from the read to the end of the call is greater than half of the worst case resolution for TOD.

The "Set TOD" option must adjust the time stored in the TOD clock if the time from the beginning of the call to the completion of the write is greater than half of the worst case resolution for TOD.

## TABLE OF CONTENTS

4. PDC Procedures . . . . .	4-1
4.1 Calling Conventions . . . . .	4-2
4.1.1 Processor State . . . . .	4-2
4.1.2 Register State . . . . .	4-3
4.1.3 Stack Usage . . . . .	4-7
4.1.4 Arguments . . . . .	4-7
4.1.5 Return Parameters . . . . .	4-8
4.1.6 Status . . . . .	4-8
4.1.7 Interruptions . . . . .	4-9
4.1.8 Powerfail Warning on Central Bus during PDC Call . . . . .	4-9
4.2 PDC Procedures . . . . .	4-11
Check Type . . . . .	4-68
Cache Check . . . . .	4-68
TLB Check . . . . .	4-70
Bus Check . . . . .	4-71
Assists Check . . . . .	4-73
Assist State . . . . .	4-73
System Responder Address . . . . .	4-74
System Requestor Address . . . . .	4-74
Path Info . . . . .	4-74
Floating-Point Coprocessor State . . . . .	4-75

This page intentionally left blank