

HP UPS Manager II

HP Computer Museum
www.hpmuseum.net

For research and education purposes only.

HP UPS Manager II



HP Part No. B4153-90002
Printed in the Federal Republic of Germany
09/96

Edition 2

© Copyright Hewlett-Packard Company, 1996. All rights reserved. Reproduction, adaptation, or translation without prior written permission is prohibited, except as allowed under copyright laws.

Legal Notices

Restricted Rights Legend

Use, duplication, or disclosure by the U.S. Government is subject to restrictions as set forth in subparagraph (c)(1)(ii) of the Rights in Technical Data and Software clause in DFARS 252.227-7013. Rights for non-DOD U.S. Government Departments and Agencies are as set forth in FAR 52.227-19(c)(1,2).

Hewlett-Packard GmbH
Herrenberger Str. 130
71034 Boeblingen, Germany

Notice

The information contained in this document is subject to change without notice. *Hewlett-Packard makes no warranty of any kind with regard to this manual, including, but not limited to, the implied warranties of merchantability and fitness for a particular purpose.* Hewlett-Packard shall not be liable for errors contained herein or for incidental or consequential damages in connection with the furnishing, performance, or use of this material.

Warranty

A copy of the specific warranty terms applicable to your Hewlett-Packard product and replacement parts can be obtained from your local Sales and Service Office.

Printing History

First Edition — June 1996

Second Edition — September 1996

Preface

Preface

This manual describes HP UPS Manager II, an HP software product for HP UPS systems.

This manual assumes that you are familiar with the contents of the product documentation supplied with your HP UPS system.

- ® HP PowerManagement is a registered trademark of Hewlett-Packard Company.
- ® HP PowerTrust is a registered trademark of Hewlett-Packard Company.
- ® HP OpenView is a registered trademark of Hewlett-Packard Company.
- ® Microsoft is a registered trademark of Microsoft Corp.
- ® Windows and Windows NT are registered trademarks of Microsoft Corp.
- ® Novell is a registered trademark of Novell, Inc.

Cover paper produced without chlorine bleaching.

Contents

1. Introduction

About HP UPS Manager II	1-2
Complete Hardware and Software Solution	1-2
Definition of Concepts and Terms	1-3
HP UPS Manager II Management Station.....	1-3
HP UPS Manager II Monitoring Station	1-3
HP UPS Manager II Managed Nodes	1-4
UPS Protected Nodes	1-4
Logically Dependent Nodes	1-5
HP UPS Manager II Monitored Nodes	1-5
HP UPS Manager II Agent	1-5
UPS Protected Physical Components	1-6
HP UPS Manager II Support User.....	1-6
Functionality	1-7
Power Resource Management	1-7
Power Scheduling	1-7
Dependency Management	1-7
Alarm Configuration.....	1-8
GUI and Graphical Status Indication.....	1-8
Diagnostics	1-8
Problem Management.....	1-8
Multi-Vendor Client Support	1-8
Coexistence with HP UPS Manager III.....	1-9
Licensing Policy.....	1-10
UPS Power Management Rules	1-12
Rule # 1	1-12

Contents

Rule # 2	1-12
Rule # 3	1-12
Rule # 4	1-12
Rule # 5	1-12
Rule # 6	1-13
Rule # 7	1-13
Rule # 8	1-13
Rule # 9	1-13
Rule # 10	1-13
Simple Scenario: Single Computer, Single UPS	1-14
Simple Scenario: Two Computers, Single UPS	1-15
Complex Scenario: Distributed Client/Server Environment	1-16
Logical Topology	1-17
Physical Topology	1-18
Defining the Shutdown Sequence	1-19
Identifying the Required UPS Dimensions	1-19
What Will Happen in the Event of a Power Failure?	1-21
2. Installing HP UPS Manager II on HP-UX Rev. 9 Systems	
System Requirements	2-3
HP UPS Manager II Management Station Requirements	2-3
Hardware	2-3
Disk Space Requirement	2-3
Operating System	2-3
Network	2-3

Contents

HP UPS Manager II Managed/Monitored Node Computers	2-3
Hardware	2-3
Disk Space Requirements.....	2-3
Operating System	2-4
Network	2-4
UPS Hardware	2-4
I. Preparation	2-5
Obtaining Your Codeword(s).....	2-5
Identifying the LAN ID of your Management Station	2-5
Additional Preparatory Steps.....	2-6
Next Steps	2-6
II. Software Installation Procedure	2-7
Stage 1: Copying the HP UPS Manager II Filesets to Disk	2-7
Stage 2: Setting Up the Management Station Plus Database	2-9
Stage 3: Installing Additional HP UPS Manager II Codeword(s).....	2-9
Stage 4: Installing the Client Filesets on each Managed Node	2-10
Results of the Installation and Configuration Procedure	2-13
Next Steps	2-13
3. Installing HP UPS Manager II on HP-UX Rev. 10 Systems	
System Requirements.....	3-3
HP UPS Manager II Management Station Requirements.....	3-3
Hardware	3-3
Disk Space Requirement	3-3
Operating System	3-3

Contents

Network.....	3-3
HP UPS Manager II Managed/Monitored Node Computers.....	3-3
Hardware.....	3-3
Disk Space Requirements.....	3-3
Operating System.....	3-4
Network.....	3-4
UPS Hardware.....	3-4
I. Preparation.....	3-5
Obtaining Your Codeword.....	3-5
Identifying the LAN ID of your Management Station.....	3-5
Additional Preparatory Steps.....	3-6
Next Steps.....	3-6
II. Software Installation Procedure.....	3-7
Stage 1: Copying the HP UPS Manager II Filesets to Disk.....	3-7
Stage 2: Setting up the Management Station plus Database.....	3-11
Stage 3: Installing Additional HP UPS Manager II Codeword(s).....	3-12
Stage 4: Installing the Client Filesets on each Managed Node.....	3-14
Results of the Installation and Configuration Procedure.....	3-16
Next Steps.....	3-16
4. Connecting and Configuring HP PowerTrust UPS Devices	
Connecting HP PowerTrust UPS Devices.....	4-3
Simple Scenario: Single Computer, Single UPS.....	4-3
Simple Scenario: Two Computers, Single UPS.....	4-4
Complex Scenario: Distributed Client/Server Environment.....	4-5

Contents

Installing and Setting Up the Proxy Agent	4-6
Result	4-7
Next Steps	4-7

5. Connecting and Configuring HP PowerManagement UPS Devices

Connecting HP PowerManagement UPS Devices.....	5-3
Simple Scenario: Single Computer, Single UPS	5-4
Simple Scenario: Two Computers, Single UPS.....	5-5
Complex Scenario: Distributed Client/Server Environment	5-6
Configuring SNMP Interface Modules	5-7
Preparatory Steps	5-7
Procedure	5-8
Result	5-13

6. Adding the First UPS and Assigning a UPS Protected Node Computer

Stage 1: Adding the UPS to the UPS Domain Map.....	6-3
Stage 2: Configuring the UPS	6-7
Stage 3: Defining a Computer as a UPS Dependent Node	6-9
Stage 4: Configuring the UPS Dependent Node Computer	6-13
Stage 5: Verifying the Community of the UPS Dependent Node	6-15

Contents

Stage 6: Test.....	6-16
Results.....	6-18
Next Steps.....	6-18

7. The HP UPS Manager II User Interface

Using the HP UPS Manager II Management Station	7-3
The HP UPS Manager II User Interface on the Management Station	7-4
The UPS Domain Map	7-4
The UPS Segment Map	7-5
The File Server Map.....	7-6
Generic Map Buttons.....	7-7
The HP UPS Manager II Pulldown Menus	7-7
File.....	7-8
Edit	7-9
UPS.....	7-9
Node	7-9
Schedule	7-10
View.....	7-10
Options	7-11
Help	7-11
Generic Buttons.....	7-11
The HP UPS Manager II User Interface on Managed Node Computers..	7-12
HP UPS Manager II Traffic Lights.....	7-12
Displaying the Traffic Lights Window.....	7-12
Including the Traffic Lights in the HP VUE GUI Bar	7-13

Contents

Removing the Traffic Lights Window	7-14
HP UPS Manager II Warning Messages	7-15

8. Global Preferences

Setting Time Intervals	8-3
UPS Map Update Interval	8-3
Node Polling Interval HP UPS Manager II	8-3
UPS Discovery Interval	8-4
UPS Status Polling Interval	8-4
UPS Power Scheduling Interval	8-4
Warning Messages on Alarm	8-5
Restore Defaults	8-6

9. Configuring UPS Devices

Adding an HP PowerTrust UPS Device	9-2
Adding an HP PowerManagement UPS Device	9-3
Configuring a UPS Device	9-4
Modifying Alarm Conditions	9-5
SNMP Port Configuration	9-6
Selecting a Different SNMP Port	9-6
Next Steps	9-7

Contents

10. Setting Up UPS Protected Nodes and Defining Logical Dependencies

Assigning an HP UPS Manager II Managed Node to its Associated UPS Device	10-3
Next Steps	10-6
Defining the Logical Dependencies of each HP UPS Manager II Managed Node.....	10-7
Next Steps	10-10

11. Defining Alarm Actions for HP UPS Manager II Managed Nodes

Selecting an Alarm Condition and Defining Alarm Actions	11-3
HP UPS Manager II Alarm Action Settings and Parameters	11-6
Alarm.....	11-6
Handle Alarm	11-6
Inform Clients.....	11-6
Action Delay.....	11-6
Action Duration	11-7
Message to User	11-7
Action Script.....	11-7

12. Power Scheduling

Defining a Power Schedule.....	12-3
Defining Additional Power Schedules.....	12-6

Contents

Overlapping Schedules	12-6
Schedule 1	12-6
Schedule 2	12-6
Combined Effect of Schedules 1 and 2	12-6
Schedule Action	12-8

13. Monitoring the Status of UPS Devices

UPS Operating Parameters	13-3
Active Alarms	13-3
Seconds on Battery	13-3
Frequency	13-3
UPS Temperature	13-3
UPS Time	13-3
System Action Time	13-4
UPS Time Bar	13-4
Battery Voltage Bar	13-4
UPS Load Bar	13-4
Input Line Bar	13-5

14. Testing a UPS Device

Supported UPS Tests	14-3
---------------------------	------

A. IETF RFC 1628 UPS-MIB II Conditions

Supported IETF RFC 1628 UPS-MIB II Conditions	A-2
---	-----

Contents

Interpreting the MIB Tree.....	A-2
The MIB Tree	A-2
Supported Alarm Conditions	A-5
IETF RFC 1628 UPS-MIB II Standard Alarm Conditions	A-6
BatteryBad	A-6
OnBattery *	A-6
LowBattery *	A-7
DepletedBattery	A-7
TempBattery	A-8
InputBad	A-8
OutputBad	A-9
OutputOverload	A-9
OnBypass.....	A-10
BypassBad	A-10
OutputOffAsRequested	A-11
UpsOffAsRequested	A-11
ChargerFailed	A-12
UpsOutputOff	A-12
UpsSystemOff	A-12
FanFailure.....	A-13
FuseFailure	A-13
GeneralFault *	A-14
DiagnosticTestFailed	A-14
CommunicationLost *	A-15
AwaitingPower	A-15
ShutdownImminent	A-16
ShutdownPending.....	A-16
TestInProgress	A-17

Contents

Additional HP UPS Manager II Specific Alarm Conditions	A-18
-Scheduled-Action *	A-18
<server name>-Down *	A-18

B. Event Logging

C. HP UPS Manager II Database Maintenance Utilities

List of Utilities	C-3
cleardb.....	C-3
createdb.....	C-3
delnode.....	C-3
readdef	C-3
resetdb.....	C-3
rmdb.....	C-4
showdb.....	C-4

D. Troubleshooting

Application Problems, Remedies and Workarounds.....	D-2
General Problems.....	D-2
SNMP Related Problems	D-3
Tasks	D-5
Required Processes	D-6
General Processes	D-6
Proxy Agent Processes	D-6

Contents

E. Examples

About This Appendix	E-2
Example 1	E-3
Network Structure	E-3
Dependency Structure	E-4
Procedure	E-4
Defining UPS Protected Nodes	E-5
Defining Alarm Actions	E-5
Defining Logical Dependencies	E-7
Alarm Actions	E-8
Client 1	E-8
Client 2	E-9
Server	E-9
Timing Diagrams	E-10
Client 1	E-10
Client 2	E-11
Server	E-11
UPS	E-12
Example 2	E-13
Network Structure	E-13
Dependency Structure	E-14
Alarm Actions	E-14
Client 1	E-15
Client 2	E-15
Client 3	E-15
Client 4	E-16
Server 1	E-16

Contents

Server 2.....	E-16
Timing Diagrams	E-16
Client 1	E-17
Client 2	E-17
Client 3	E-18
Client 4	E-18
Server 1.....	E-19
Server2.....	E-19
UPS 1.....	E-19
UPS 2.....	E-20



Contents

Introduction

About HP UPS Manager II

HP UPS Manager II is an industry-standard based power management solution for today's distributed multi-vendor IT environments. Providing intelligent UPS (Uninterruptible Power Supply) management capabilities, HP UPS Manager II protects active and passive network components. It is designed for seamless integration with the entire network and system management of the customer's IT structure.

HP UPS Manager II provides a full range of network monitoring, identification and mapping capabilities based on an Open Systems standard architecture.

HP UPS Manager II consists of four fully integrated components:

- HP UPS Manager II Management Station
- HP UPS Manager II Client
- HP PowerTrust UPS plus Proxy Agent
- HP PowerManagement UPS plus SNMP Interface Module

This precisely tuned match of sophisticated software and robust hardware ensures maximum protection from AC power problems.

Complete Hardware and Software Solution

HP UPS Manager II is part of a UPS management and control software family comprising the following products:

- 1 HP UPS Manager I - designed to protect one or two CPUs connected to the same UPS (not used with HP PowerTrust UPSs)
- 2 B4153A - HP UPS Manager II - easy to use single UPS network management which does not require HP OpenView Network Node Manager
- 3 B4152A - HP UPS Manager III - fully integrated in HP OpenView Network Node Manager

A wide range of UPS devices is available for these software solutions. For a complete list of supported UPS devices, refer to the *HP PowerManagement Solutions Product Brief*.

NOTE:

For detailed information on your HP UPS device, please refer to the documentation supplied with your HP UPS.

Definition of Concepts and Terms

The following HP UPS Manager II concepts and terms are discussed below:

- HP UPS Manager II Management Station
- HP UPS Manager II Managed Nodes
- HP UPS Manager II Monitored Nodes
- HP UPS Protected Physical Components
- HP UPS Management Support User

HP UPS Manager II Management Station

The HP UPS Manager II Management Station serves as an AC power management console for the entire network or a sub-segment of your network. The logical and physical links of the entire IT environment or sub-segments thereof can be fully mapped in HP UPS Manager II. With the aid of its powerful monitoring and control functionality, the HP UPS Manager II Management Station handles all communication between UPSs and the computer systems they back up.

Based on the specific UPS configuration of the computer network, the HP UPS Manager II Management Station continuously monitors the status of UPS equipment in the network and indicates any status changes (such as alarm conditions) plus appropriate actions.

With its rich functionality, the HP UPS Manager II Management Station ensures robust power and system monitoring even in very large distributed network structures (such as Wide Area Networks).

HP UPS Manager II Monitoring Station

In addition to HP UPS Manager II Management Stations, you can also set up HP UPS Manager II Monitoring Stations. Unlike the Management Station, the HP UPS Manager II Monitoring Station does not provide active control but monitors the UPS

Introduction

Definition of Concepts and Terms

protected nodes for comprehensive feedback on the power protection status. This additional monitoring capability is needed in distributed WAN environments where UPS devices are monitored globally and managed (controlled) locally.

HP UPS Manager II Managed Nodes

Any network manageable device that has its own IP address can be set up as an HP UPS Manager II managed node. This definition includes computers as well as routers and other active network components.

The HP PowerClient control program runs on each HP UPS Manager II managed node in the network. From the HP UPS Manager II Management Station (serving as the central console), this control program can be configured for the specific requirements of each HP UPS Manager II managed node and its associated operating system.

Each HP UPS Manager II managed node is either:

- a UPS protected node
- or
- a logically dependent node

or both.

UPS Protected Nodes

In the context of this manual, the term *UPS protected node* applies to active network components which are physically connected to a given UPS device and which are allocated to that UPS device.

During normal operation, the HP PowerClient control program indicates that the UPS protected node it runs on is protected from power failures. If an AC line power failure occurs, the control program initiates a graceful shutdown within the UPS power backup period.

On HP UPS Manager II UPS protected HP-UX node computers, a power protection status window (resembling traffic lights) can be displayed to indicate the current UPS protection status. Alternatively, these “traffic lights” can be displayed as an icon in the HP VUE bar of each HP UPS Manager II UPS protected node computer.

To ensure a cascaded shutdown of UPS protected nodes in a client/server environment, the associated *logical dependencies* (discussed below) need to be mapped in HP UPS Manager II.

NOTE:

In the context of this manual, the terms *HP UPS Manager II UPS protected node* and *UPS protected node* are equivalent.

Logically Dependent Nodes

In the context of this manual, a *logically dependent node* is defined as an HP UPS Manager II managed node that is assigned to another HP UPS Manager II managed node on which it depends.

Logical dependencies enable you to account for client/server relationships and other hierarchical constraints. HP UPS Manager II enables you to map multiple dependency levels.

Typical examples of *logically dependent nodes* include:

- clients attached to a UPS protected server
- computers attached to a router in your network

The effect of this logical dependency is described in the following example:

A client computer is located in site A. This client is logically dependent on a UPS protected server located in site B (acting as a file server). In the event of an AC line power failure in site B, the server receives battery buffered AC power from its UPS and issues an appropriate warning message to its client in site A, instructing the user of the client computer to log off.

NOTE:

Any logically dependent nodes for which you want to ensure UPS protection need to be set up as UPS dependent nodes.

HP UPS Manager II Monitored Nodes

In addition to HP UPS Manager II managed nodes, you can also set up HP UPS Manager II *monitored nodes*. The HP UPS Manager II Monitoring Station allocated to such nodes does not provide active control but only monitors the nodes for comprehensive feedback on the power protection status. This additional monitoring capability is needed in distributed WAN environments where UPS devices are monitored globally and managed locally.

HP UPS Manager II Agent

The HP UPS Manager II Agent is an SNMP based sub-agent running with the HP-UX SNMP master agent.

Introduction

Definition of Concepts and Terms

The HP UPS Manager II agent handles the MIB-II (a standard MIB already included in the Extensible SNMP Agent) and a special HP UPS Manager MIB which is designed for action management.

Once the HP UPS Manager II agent is running on an HP UPS Manager II managed node (controlled by the HP UPS Manager II Management Station), HP UPS Manager II is able to communicate with this node via the SNMP protocol and this agent. The HP UPS Manager II database holds information on the alarm actions configured for each HP UPS Manager II managed node. This information is only sent to each UPS managed node in the event of an alarm.

UPS Protected Physical Components

Each UPS device powers one or more passive or active network components such as workstations, servers, PCs, routers, hubs, etc. For HP PowerManagement UPS devices, network communication is handled through an SNMP interface. The UPS is connected to the SNMP interface via a separate cable. The SNMP interface converts all information sent from the UPS to SNMP UPS MIB values. For HP PowerTrust UPS devices, network communication is handled via the HP PowerTrust proxy agent running on a UPS protected computer system. These values are then polled and interpreted by HP UPS Manager II.

HP UPS Manager II Support User

To facilitate administrative tasks in the area of UPS protection management, HP UPS Manager III enables you to set up a separate support user during the installation procedure. This support user does not require a special "root" password. The administrator or service operator can thus check HP UPS Manager II data and processes without needing superuser capabilities.

This new role lowers the skill barrier for routine tasks. For instance, the HP UPS Manager II Support User:

- creates power management databases
- removes power management databases
- starts and stops the HP UPS Manager II daemon

Functionality

HP UPS Manager II provides a comprehensive set of features and capabilities for efficient power management in today's distributed client/server environments:

- Power resource management
- Power scheduling
- Dependency management
- Alarm configuration
- GUI and graphical status indication
- Diagnostics
- Problem management
- Multi-vendor client support
- Coexistence with HP UPS Manager III

These features and capabilities are discussed in detail below.

Power Resource Management

The AC line power status of entire network systems (even if these are distributed across multiple sites) can be managed and monitored from a single console for maximum data integrity and system availability.

Power Scheduling

The scheduled shut-down and restart of idle computer systems prevents unauthorized access and helps to reduce energy costs.

Dependency Management

The system manager can write shell scripts to ensure the controlled shutdown of cluster members in the right sequence. In a client/server database environment, for instance, HP UPS Manager II messages prompt each user to log off before the client workstations are shut down. This allows the database server to shut down only after all of its clients have disconnected from it. Such constraint mechanisms ensure full data integrity and trouble-free system recovery.

Alarm Configuration

Each HP UPS Manager II managed node in your network can be configured to handle or ignore conditions associated with AC power or UPS related problems.

For example, in the event of an AC line power failure invoking the OnBattery alarm condition, a UPS protected computer will handle this alarm condition and will commence to run on battery buffered power supplied by its associated UPS until the shutdown process is completed.

GUI and Graphical Status Indication

The intuitive GUI of HP UPS Manager II provides easy-to-grasp status maps, messages and prompts. HP UPS Manager II continuously monitors the UPS supported AC power status of your network and provides graphical feedback. Preventive maintenance (such as battery replacement) is fully supported by a comprehensive set of status checks and associated power management display panels.

A protection status icon resembling traffic lights informs the user on the current "UPS protection OK/no connection to server/alarm" status.

Diagnostics

Sophisticated diagnostics help to identify UPS problems (such as an exhausted battery) up-front for cost-effective preventive maintenance.

Problem Management

AC line power related problems are quickly and easily resolved with the aid of comprehensive network maps and meaningful messages. A set of corrective actions and associated user messages can be defined for each potential AC power related problem.

Multi-Vendor Client Support

HP UPS Manager II supports a number of UNIX based client platforms as well as PCs running popular operating systems such as Microsoft NT and Novell.

Coexistence with HP UPS Manager III

HP UPS Manager II and HP UPS Manager III are designed to complement each other for maximum protection. For instance, while HP UPS Manager III monitors the UPS performance and AC power status of your enterprise, you can implement HP UPS Manager II in user-definable sub-segments of your network. This ensures enterprise-wide monitoring plus full local protection.

Licensing Policy

HP UPS Manager II requires a separate codeword for each link between:

- a UPS device and its Management Station
- a UPS device and its Monitoring Station (if any)

A codeword for your your first UPS monitoring or management link is included in the scope of delivery of HP UPS Manager II. Any additional licenses must be purchased separately (option #001). For instance, if your configuration includes a single Management Station managing three UPS devices, you need two additional codewords - regardless of the number and types of nodes (computers, monitors, routers, etc.) connected to each UPS device.

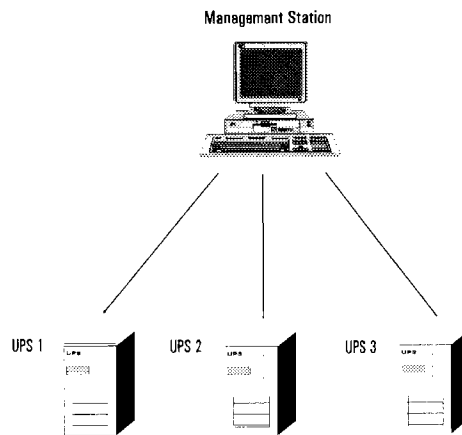

Figure 1-1

Single Management Station, Multiple UPS Devices

Or, in a two-site configuration equipped as shown below, you would require a total of nine codewords:

- The Site 1 Management Station manages **four** local UPS devices. The same computer also serves as the Monitoring Station for **two** critical UPS devices managed by the Site 2 Management Station. This configuration requires a total of six codewords.
- The Site 2 Management Station manages **three** local UPS devices. This configuration requires three codewords.

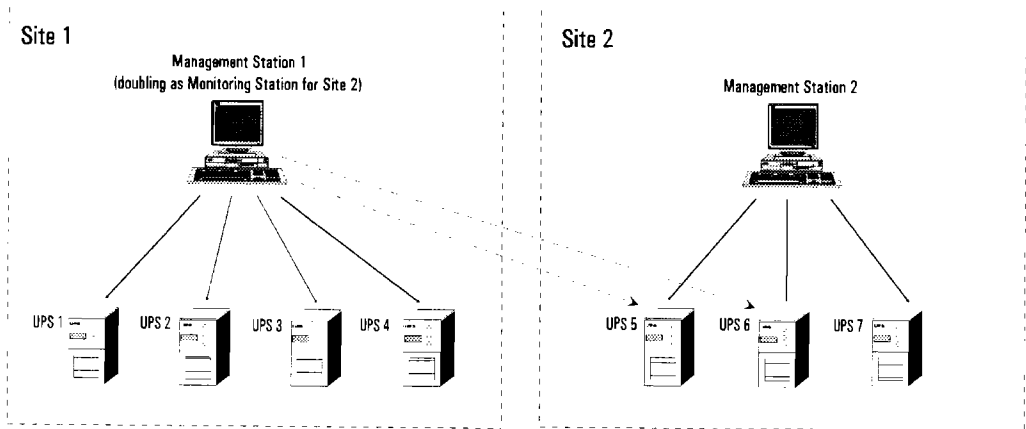

Figure 1-2 Two Management Stations, Single Monitoring Station

In the sample configuration shown above, the Site 1 UPS devices remain fully managed even if there is a WAN problem impacting on communication with Site 2. If the UPS management subnet at Site 1 fails, Site 2 remains fully managed. If the UPS management subnet at Site 2 fails, the Monitoring Station located at Site 1 will keep monitoring the UPS devices at Site 2 (provided that the WAN connection to Site 2 is OK).

NOTE:

Please note that the loads (computers, monitors, routers, ...) you connect to each UPS are at your discretion. You do not require any separate codewords for these UPS protected devices. However, be sure to observe the rules specified in the following section.

UPS Power Management Rules

To get the most out of your HP UPS Manager II investment, you need to be aware of the UPS power management rules and usage concepts presented below.

Compliance with the rules specified below is an essential prerequisite for ensuring maximum availability of network components, for preventing any irregular shut-down of components due to AC power problems, and for ensuring automatic restart and reboot following a power failure.

Rule # 1

Be sure to know the AC power requirements of each UPS protected component in your network. When measuring the AC power requirements, be sure to account for additional load conditions such as disk drive activity.

Rule # 2

Be sure to know the shutdown period of each computer in your UPS supported network and the shutdown sequence of your computers.

Rule # 3

Once you have identified the shutdown period of each UPS supported computer, allow a sufficient time margin when calculating the required UPS battery capacity.

Rule # 4

The UPS measures (battery capacities and shutdown sequences) for all active network components (routers, hubs, bridges) need to be dimensioned such that the clients in each client/server cluster are able to shut down before their associated network components are shut down. This requirement ensures uptime until all clients are down.

Rule # 5

In a multiple-server environment, a “cascaded” shutdown sequence of servers has to be implemented in order to ensure that the “topmost” server goes down last.

Rule # 6

Remember that **all** AC power outlets of a given UPS device power down simultaneously. If any UPS supported computer initiates a UPS shutdown, the power to any computers sharing the same UPS will also be powered down. The UPS will be shut down regardless of the recovery or non-recovery of regular AC line power. This measure ensures that the cluster affected by AC line power failure reaches a defined state for subsequent restart and recovery.

Rule # 7

If you are using multiple management stations, be sure that these do not define conflicting actions and other parameter settings for the same node.

Rule # 8

Each UPS should be managed by a **single management station** but can be monitored by **multiple monitoring stations**.

Rule # 9

The entire AC power network needs to be documented. The associated logical map in HP UPS Manager II has to comply with the physical network and has to pass an acceptance test. The scope of acceptance should include such items as adhesive labels on devices, color coded cabling, and a layout plan.

Rule # 10

To ensure maximum benefit from your UPS investment, it may be a good idea NOT to connect non-critical devices (such as some client workstation monitors) to a UPS.

Simple Scenario: Single Computer, Single UPS

If you want to provide UPS protection to a single computer, the method is very simple. After installing HP UPS Manager II on that workstation, simply add the UPS to the UPS Domain Map on that workstation. Then define the workstation as a UPS dependent node.

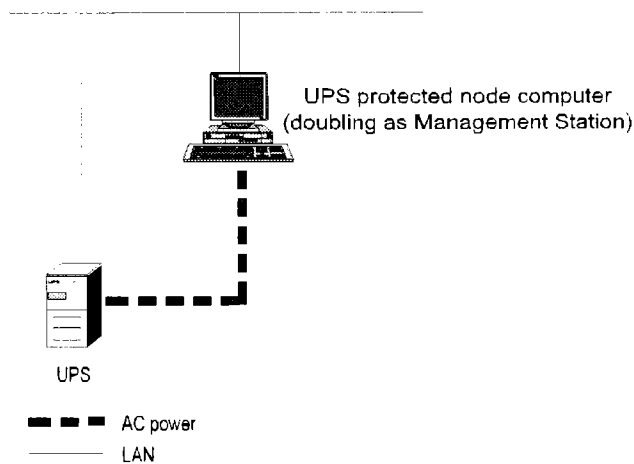

Figure 1-3

Single Computer, Single UPS

If you want to add a second computer as a UPS protected node, proceed as shown in the following section.

Simple Scenario: Two Computers, Single UPS

If you want to set up two UPS protected node computers sharing the same UPS, proceed as described in the previous section. Then assign the second computer to that UPS. If there are any logical client/server dependencies between these two computers, HP UPS Manager II enables you to define these, too.

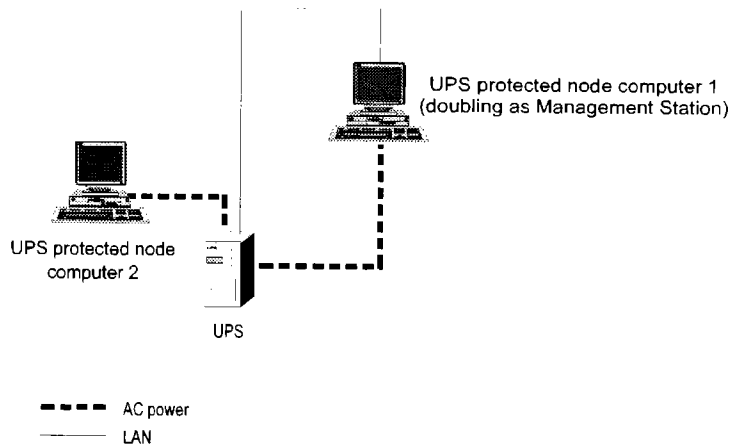

Figure 1-4

Two Computers, Single UPS

Complex Scenario: Distributed Client/Server Environment

This section discusses the general concepts, dependency considerations and constraints of using UPS devices in a distributed client/server environment.

The following example of a distributed client/server environment is intended to show you how to make sure that your environment is protected from AC power failures.

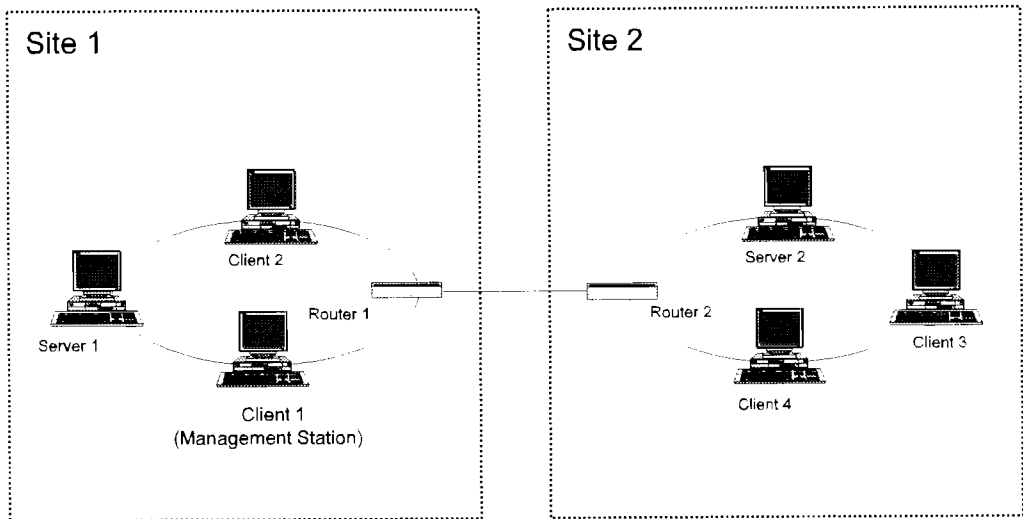

Figure 1-5

Distributed Client/Server Environment

The following UPS measures need to be implemented:

- All of the computers and active network devices shown in this scenario require adequate UPS protecting. All relevant physical constraints (such as power input, required “time on battery”, and physical location) need to be taken into account.
- The HP UPS Manager II Management Station and the routers need to remain “up” until all other UPS protected computers have been shut down. Therefore, the Management Station and the routers require separate UPS protection.

IETF RFC 1628 UPS-MIB II Conditions
Supported IETF RFC 1628 UPS-MIB II Conditions

```

4: upsInputmandatory
5: upsInputTruePower
4: upsOutput
  1: upsOutputSource *
  2: upsOutputFrequency *
  3: upsOutputNumLines *
  4: upsOutputTable
    1: upsOutputEntry
      1: upsOutputLineIndex *
      2: upsOutputVoltage *
      3: upsOutputmandatory
      4: upsOutputPower
      5: upsOutputPercentLoad
5: upsBypass
  1: upsBypassFrequency
  2: upsBypassNumLines
  3: upsBypassTable
    1: upsBypassEntry
      1: upsBypassLineIndex
      2: upsBypassVoltage
      3: upsBypassmandatory
      4: upsBypassPower
6: upsAlarm
  1: upsAlarmsPresent *
  2: upsAlarmTable
    1: upsAlarmEntry
      1: upsAlarmId *
      2: upsAlarmDescr *
      3: upsAlarmTime *
  3: upsWellKnownAlarms
    1: upsAlarmBatteryBad
    2: upsAlarmOnBattery *
    3: upsAlarmLowBattery *
    4: upsAlarmDepletedBattery
    5: upsAlarmTempBad
    6: upsAlarmInputBad
    7: upsAlarmOutputBad
    8: upsAlarmOutputOverload
    9: upsAlarmOnBypass
    10: upsAlarmBypassBad
    11: upsAlarmOutputOffAsRequested
    12: upsAlarmUpsOffAsRequested *
    13: upsAlarmChargerFailed
    14: upsAlarmUpsOutputOff
    15: upsAlarmUpsSystemOff
    16: upsAlarmFanFailure
    17: upsAlarmFuseFailure
    18: upsAlarmGeneralFault *
    19: upsAlarmDiagnosticTestFailed
    20: upsAlarmCommunicationsLost *
    21: upsAlarmAwaitingPower
```

IETF RFC 1628 UPS-MIB II Conditions

Supported IETF RFC 1628 UPS-MIB II Conditions

- 22: upsAlarmShutdownPending
- 23: upsAlarmShutdownImminent
- 24: upsAlarmTestInProgress
- 7: upsTest
 - 1: upsTestId *
 - 2: upsTestSpinLock
 - 3: upsTestResultsSummary
 - 4: upsTestResultsDetail
 - 5: upsTestStartTime
 - 6: upsTestElapsedTime
 - 7: upsWellKnownTests
 - 1: upsTestNoTestsInitiated
 - 2: upsTestAbortTestInProgress
 - 3: upsTestGeneralSystemsTest
 - 4: upsTestQuickBatteryTest
 - 5: upsTestDeepBatteryCalibration
- 8: upsControl
 - 1: upsShutdownType *
 - 2: upsShutdownAfterDelay *
 - 3: upsStartupAfterDelay *
 - 4: upsRebootWithDuration *
 - 5: upsAutoRestart *
- 9: upsConfig
 - 1: upsConfigInputVoltage
 - 2: upsConfigInputFreq
 - 3: upsConfigOutputVoltage
 - 4: upsConfigOutputFreq
 - 5: upsConfigOutputVA
 - 6: upsConfigOutputPower
 - 7: upsConfigLowBattTime
 - 8: upsConfigAudibleStatus
 - 9: upsConfigLowVoltageTransferPoint
 - 10: upsConfigHighVoltageTransferPoint
- 2: upsTraps
 - 4: upsTrapAlarmEntryRemoved
 - 3: upsTrapAlarmEntryAdded
 - 1: upsTrapOnBattery
 - 2: upsTrapTestCompleted

Dependencies

The following dependencies need to be taken into account:

- Client 1 is the HP UPS Manager II Management station for both sites.
- Server 1 is the database server for all clients in both sites.
- Server 2 is the NFS server for Client 1 and Client 2.
- Client 2 is the application server for Client 3.

Logical Topology

A possible logical topology for this scenario is shown in Figure 1-6 below.

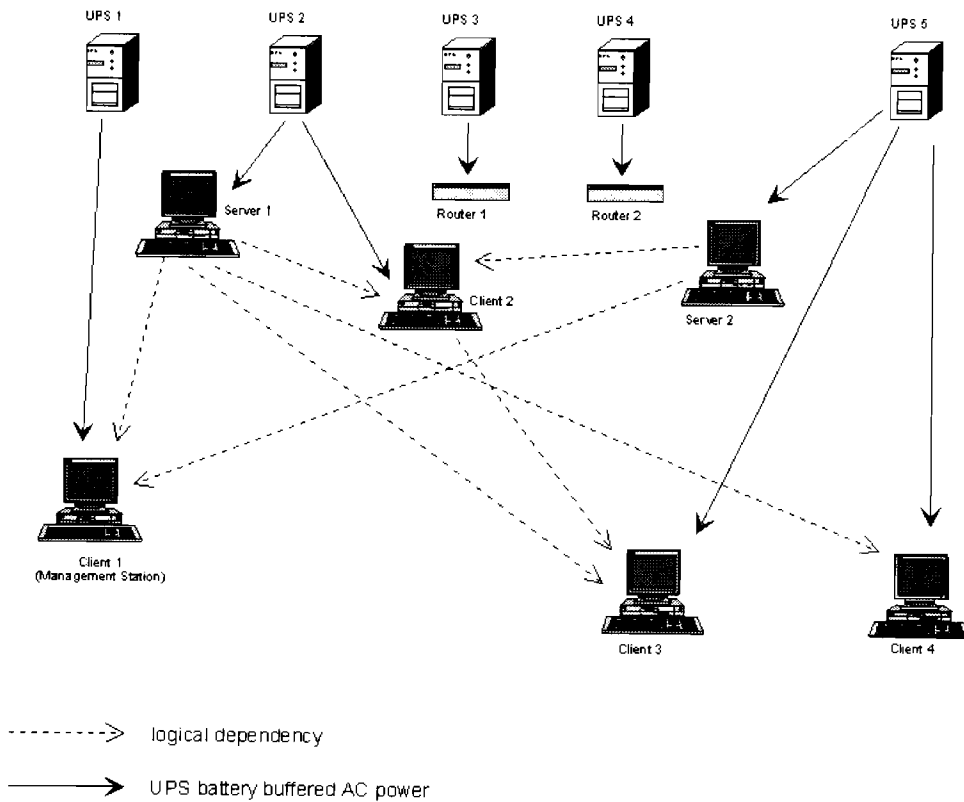

Figure 1-6 Logical Topology

The definition of logical client/server dependencies is discussed in *Chapter 10*.

Complex Scenario: Distributed Client/Server Environment

Physical Topology

The associated physical topology is shown in Figure 1-7 below.

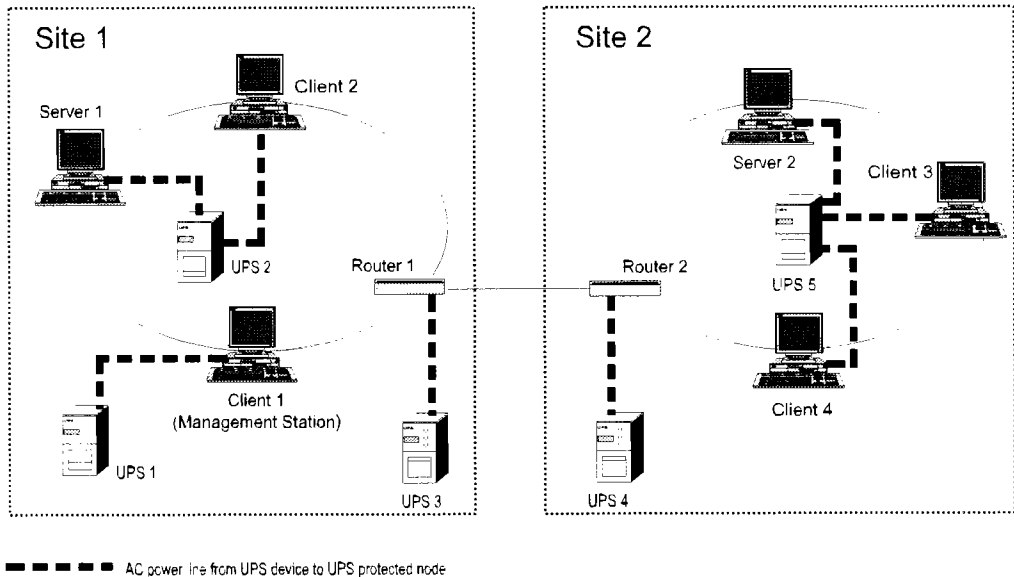

Figure 1-7

Physical Topology

The physical topology includes the following physical UPS configuration:

- UPS 1 is connected to Client 1 (serving as the HP UPS Manager II Management Station) only.
- UPS 2 is connected to both Server 1 and Client 2.
- UPS 3 is connected to Router 1 only.
- UPS 4 is connected to Router 2 only.
- UPS 5 is connected to Server 2, Client 3 and Client 4.

The required capacity of each UPS device is governed by the power input of each device connected to it **plus** the required “time on battery”. Since all devices connected to a given UPS are powered down simultaneously, the “time on battery” is governed by the “last” device in the logical shutdown sequence. These issues are addressed in the following sections.

Complex Scenario: Distributed Client/Server Environment

NOTE:

In HP UPS Manager II, each computer or other active network component physically connected to its UPS device needs to be defined as a *UPS protected (i.e. UPS dependent) node*.

Defining the Shutdown Sequence

A graceful shutdown changes your entire cluster to a defined status from which normal operation can be resumed. To ensure a graceful shutdown of the entire sample environment, in the event of a power failure, you need to configure the HP UPS Manager II managed nodes to shut down in the following sequence:

- 1 Client 3 and Client 4 (both in site 2) concurrently. Let us assume that the duration of this shutdown process is 3 minutes.
- 2 Client 2 (serving as the application server of Client 3). Let us assume that the duration of this shutdown process is 2 minutes.
- 3 Server 1 (serving as the database server for all client workstations). Let us assume that the duration of this shutdown process is 4 minutes.
- 4 Client 1 (the HP UPS Manager II Management Station). Let us assume that the duration of this shutdown process is 3 minutes.
- 5 Server 2 (the NFS server for Client 1 and Client 2). Let us assume that the duration of this shutdown process is 1 minute.
- 6 Router 1 and Router 2 concurrently. Let us assume that the duration of this shutdown process is 1 minute.

NOTE:

When defining the action delay for each HP UPS Manager II managed node, be sure to allow sufficient time periods for the sequenced shutdown of the individual nodes.

Identifying the Required UPS Dimensions

The shutdown sequence defined above implies the following minimum “time on battery” for the five UPS devices in the sample scenario:

- UPS 1 needs to provide sustained AC power until Client 1 shuts down. This implies that UPS 1 needs to provide a “time on battery” equivalent to the cumulative time of shutdown steps 1 through 5 above. The timing assumptions in this example imply that the minimum “time on battery” for UPS 1 is 13 minutes.
- UPS 2 needs to provide sustained AC power until Server 1 shuts down. This implies that UPS 2 needs to provide a “time on battery” equivalent to the cumulative time of shutdown steps 1 through 3 above. The timing assumptions in this exam-

Complex Scenario: Distributed Client/Server Environment

ple imply that the minimum “time on battery” for UPS 2 is 9 minutes.

- UPS 3 needs to provide sustained AC power until Router 1 can go down. This implies that UPS 3 needs to provide a “time on battery” equivalent to the cumulative time of shutdown steps 1 through 6 above. The timing assumptions in this example imply that the minimum “time on battery” for UPS 3 is 14 minutes.
- UPS 4 needs to provide sustained AC power until Router 2 can go down. This implies that UPS 4 needs to provide a “time on battery” equivalent to the cumulative time of shutdown steps 1 through 6 above. The timing assumptions in this example imply that the minimum “time on battery” for UPS 4 is 14 minutes.
- UPS 5 needs to provide sustained AC power until Server 2 shuts down. This implies that UPS 5 needs to provide a “time on battery” equivalent to the cumulative time of shutdown steps 1 through 5 above. The timing assumptions in this example imply that the minimum “time on battery” for UPS 5 is 13 minutes.

NOTE:

When computing the required “time on battery” for each UPS device, be sure to include a sufficient safety margin.

Also, UPS 3 and UPS 4 (supplying Router 1 and Router 2, respectively) may only need to provide a low current; however, the “time on battery” is rather long.

What Will Happen in the Event of a Power Failure?

If an AC line power outage occurs in the scenario described above, this UPS configuration ensures a graceful shutdown of the entire client/server environment.

As soon as HP UPS Manager II detects a power failure which exceeds the peak delay defined for a given UPS device, the HP UPS Manager II traffic lights on each HP UPS Manager II managed node computer will change to **red**. At the same time, an alarm message is displayed on each HP UPS Manager II managed node computer.

The use of shell scripts for controlling the shutdown of each HP UPS Manager II managed node computer in a client/server configuration is illustrated in *Appendix E*.

Introduction

What Will Happen in the Event of a Power Failure?

**Installing HP UPS Manager II on
HP-UX Rev. 9 Systems**

Installing HP UPS Manager II on HP-UX Rev. 9 Systems

To install HP UPS Manager II on systems running HP-UX rev. 9, you need to complete the following steps:

- Read the *Requirements* section below. Obtain your HP UPS Manager II code-word(s) and complete other preparatory steps.
- Install the appropriate HP UPS Manager II filesets on the HP UPS Manager II Management Station.
- Install the appropriate HP UPS Manager II filesets on each HP UPS Manager II managed node computer.

System Requirements

HP UPS Manager II Management Station Requirements

Hardware

The HP UPS Manager II Management Station has to be an HP 9000 Series 700 or Series 800 workstation (including at least 64 MB of memory, a graphics monitor, mouse and LAN card).

Disk Space Requirement

As a rule of thumb, HP UPS Manager II requires 33 MB of additional disk space for the HP UPS Manager II Management Station. The actual disk space requirement are governed by criteria such as the complexity of the networked cluster to be supported by HP UPS Manager II.

Operating System

The HP UPS Manager II Management Station requires HP-UX rev. 9.

Network

TCP/IP standard LAN.

HP UPS Manager II Managed/Monitored Node Computers

Hardware

Any HP 9000 series 700 or series 800 computer running the SNMP Master Agent module is supported as an HP UPS Manager II managed node computer. A graphics monitor is recommended.

Other popular platforms, e.g. Novell network servers and Windows NT servers, are included in the portfolio of HP UPS Manager II managed node computers. See the current HP UPS Manager II datasheet for a complete list of supported clients and further details or contact your Hewlett-Packard sales representative.

Disk Space Requirements

As a rule of thumb, HP UPS Manager II requires 2 MB of additional disk space on each HP UPS Manager II managed node computer.

Installing HP UPS Manager II on HP-UX Rev. 9 Systems

System Requirements

Operating System

HP-UX rev. 9 or HP-UX rev. 10 operating system.

Network

TCP/IP standard LAN.

UPS Hardware

HP PowerManagement UPS and/or HP PowerTrust UPS. See the *HP PowerManagement Product Brief* for a current list of supported UPSs.

I. Preparation

Before you install HP UPS Manager II, be sure to complete the following preparatory steps:

- Obtain your HP UPS Manager II codeword(s)
- Complete other preparatory steps

Obtaining Your Codeword(s)

On each HP UPS Manager II Management Station and/or Monitoring Station, you need to install a separate codeword for each UPS controlled or monitored by that station. A single license (plus associated codeword) is included in the scope of delivery of HP UPS Manager II. If you are not sure how many codewords you require for your configuration, refer to the *Licensing Policy* section in *Chapter 1* for guidance.

When requesting additional codewords, specify the LAN ID (MAC address) number of your HP UPS Manager II Management Station or Monitoring Station. Instructions for obtaining codewords are supplied on the Right-To-Use Certificate included in the HP UPS Manager II shipment package. The procedure for identifying this LAN ID number is described below.

NOTE:

If a given UPS is managed by HP UPS Manager II and monitored by UPS Manager II which runs in another segment of the network then you need **two** codewords for the same UPS: one for the Management Station and one for the Monitoring Station. (B4153A Option 001: License to use one UPS.)

Identifying the LAN ID of your HP UPS Manager II Management Station

Perform the following steps to find out the LAN station address of your HP UPS Manager II Management Station.

- 1 Log in as **root** on the HP-UX computer that you will set up as your HP UPS Manager II Management Station.
- 2 Enter the following command:

```
/etc/lanscan
```
- 3 Look under **station Address** for your LAN station address (such as

I. Preparation

0x080009 . . .). You need this LAN ID when requesting your codeword(s).

- With your HP UPS Manager II Software, you received a license certificate for using HP UPS Manager II with a single UPS. Optionally, you can order additional certificates (B4153A Option 001: License to use one UPS) to manage and/or monitor multiple UPS devices with HP UPS Manager II.
- The license certificate describes all steps required for obtaining a codeword.
- Record the codewords and/or store the codewords in a file. *Be sure to store your codewords in a safe place. Without your codeword(s), you cannot use HP UPS Manager II to manage and/or monitor UPS devices.*

The codeword installation procedure is described later in this chapter.

Additional Preparatory Steps

Ask your system administrator to obtain the IP addresses of your UPS(s).

Next Steps

You are now ready to install HP UPS Manager II.

II. Software Installation Procedure

The installation of the HP UPS Manager II software comprises the following stages:

- 1 Setting up a Netdist Server and copying the HP UPS Manager II filesets from the installation medium to disk
- 2 Setting up the HP UPS Manager II Management Station plus database
- 3 Installing your HP UPS Manager II codewords
- 4 Copying the HP UPS Manager II Client filesets to each HP UPS Manager II managed node computer

Detailed instructions for each step are provided on the following pages.

Stage 1: Copying the HP UPS Manager II Filesets to Disk

On the computer you want to use as your Netdist Server and your HP UPS Manager II Management Station, proceed as follows to copy the HP UPS Manager II filesets from the installation medium to your hard disk:

- 1 Insert the HP UPS Manager II installation medium into the drive.
- 2 Log on as superuser (root).
- 3 Specify the following command to install HP UPS Manager II:

```
/etc/update
```

NOTE:

Please note that the following instructions apply to the first-time installation procedure for HP UPS Manager II. For updates, `update` may return additional prompts and panels. For details on the `update` program, refer to your *HP-UX System Administration* and *Installing and Updating HP-UX* manuals.

- 4 In the Update Main Menu, select the following menu item:

```
Change Source or Destination
```

- 5 Select the following option:

```
From Tape Device to Local System
```

- 6 Specify the applicable source medium such as:

```
/dev/rmt/0m
```

II. Software Installation Procedure

NOTE:

For the source medium, enter the device file name of your local DAT drive.

- 7 HP UPS Manager II creates its own directory path. When prompted for the destination directory, simply enter a "slash" character:

```
/
```

- 8 Press **F4** to confirm. The system returns you to the Update Main Menu.

- 9 Select the following option:

```
Select/View Partitions and Filesets
```

- 10 Press **F4** to confirm.

- 11 Press **Y** to select the following filesets:

```
PVCLIENT  
PVLITEMGMT  
PVPROXY (if using HP PowerTrust UPS systems)
```

- 12 From the next panel, select the following option:

```
Start Loading Now
```

- 13 Before the actual copy procedure is initiated, the system prompts you to confirm your entries and selections. Provided that your entries and selections are correct, click **Yes**.

- 14 Upon completion of the copy procedure, the system prompts you to review the log file `/tmp/update.log`. This file contains useful information on the previous procedure.

NOTE:

This is a cumulative log file which will contain a complete history of events. Therefore, check for today's date to view recent information.

- 15 Optionally, you can now run the following program to set up your HP UPS Manager II Support User:

```
/usr/pvlight/bin/install_user
```

This program will add a group named `pvsupport` and a user named `powerview` to the file `/etc/group` and an entry to the file `/etc/passwd`. The group of all installed files changes to `powerview`. The database permissions are set to read and write for user and group.

Stage 2: Setting Up the HP UPS Manager II Management Station Plus Database

Proceed as follows to set up the HP UPS Manager II Management Station:

- 1 Enter the following command:

```
/usr/pv-lite/bin/pvlinstall
```

This command:

- creates the HP UPS Manager II database;
- generates default values for alarm configuration;
- starts the UPS monitor daemon.

While this command executes, the system returns a series of progress messages and prompts. For instance, you are prompted to set up a support user. (See the previous section for a description.) Upon completion of this command, your first UPS management or monitoring link is licensed. For any additional management and/or monitoring links, you can install additional HP UPS Manager II code-words as described below.

Stage 3: Installing Additional HP UPS Manager II Codeword(s)

Proceed as follows to install an additional HP UPS Manager codeword for an additional UPS device:

- 1 For each HP UPS Manager II UPS license you want to use in addition to the first license (see *Licensing Policy* in *Chapter 1*), enter the following command on the HP UPS Manager II Management Station:

```
/usr/pv-lite/bin/pvkey
```

- 2 When prompted to add a new license, press Y.
- 3 When prompted, enter the IP address for the UPS device for which you want to install a codeword. For HP PowerTrust devices, this is the IP address of the workstation where the proxy agent is running. For HP PowerManagement UPS devices, this is the IP address of the SNMP port to which you will connect the UPS device.
- 4 When prompted, enter the certificate serial number of your HP UPS Manager II Right-to-Use Certificate. This serial number is specified in the header of your HP UPS Manager II Right-to-Use certificate.
- 5 When prompted, enter the codeword you obtained (as described above) for your HP UPS Manager II Management Station.
- 6 Repeat this codeword installation procedure for any additional workstation(s)

II. Software Installation Procedure

you want to set up as an HP UPS Manager II Monitoring Station(s). When prompted, press Y for any additional license you want to install or N if you do not want to install a license for the associated workstation. If you are not sure what to do, refer to the *Licensing Policy* section in *Chapter 1*.

- 7 To verify that HP UPS Manager II has been installed properly on the Management Station, enter the following commands:

```
/usr/pvllite/bin/pvlstart  
/usr/pvllite/bin/pvlmap &
```

This command starts HP UPS Manager II and displays the UPS Domain Map. This map is initially empty because no UPS has yet been added to the map.

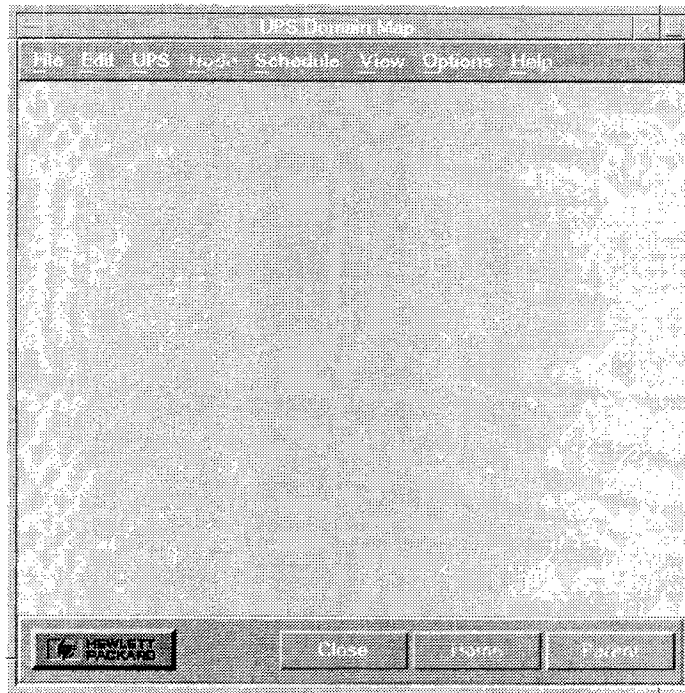

Figure 2-1

HP UPS Manager II - Empty UPS Domain Map

The entire functionality of HP UPS Manager II is accessible from this window.

Stage 4: Installing the HP UPS Manager II Client Filesets on each

II. Software Installation Procedure

Managed Node Computer

Proceed as follows to install the appropriate HP UPS Manager II filesets on each computer you want to manage or monitor from the HP UPS Manager II Management Station.

NOTE:

This procedure needs to be performed on each computer which is to be UPS protected and managed and/or monitored by the HP UPS Manager II Management Station. Remember that you have already installed the PVCLIENT fileset on your Management Station. Therefore, you do **not** need to repeat this procedure on your Management Station.

- 1 On each computer you want to set up as an HP UPS Manager II managed node, start `/etc/update` to install the HP UPS Manager II client fileset.
- 2 In the Update Main Menu, select the following menu item:
`Change Source or Destination`
- 3 Press **F4** to confirm.
- 4 Select the following option:
`From Netdist Server to Local System`
- 5 Press **F4** to confirm.
- 6 Specify the hostname of your Netdist Server (source).
- 7 Retain the root (`/`) default setting for the destination directory.
- 8 Press **F4** to confirm. The system returns you to the Update Main Menu.
- 9 Select the following option:
`Select/View Partitions and Filesets`
- 10 Press **F4** to confirm. The system returns a panel listing all filesets on the netdist server.
- 11 Select the following fileset:
`PVIEW_CLIENT`
- 12 Press **F4** to confirm.
- 13 Before the actual copy procedure is initiated, the system prompts you to confirm your entries and selections. Provided that your entries and selections are correct, select Yes.
- 14 Upon completion of the copy procedure, the system prompts you to review the

II. Software Installation Procedure

log file /tmp/update.log. This log file contains useful information on the previous procedure. Be sure to complete any corrective action specified in this log file.

Results of the Installation and Configuration Procedure

As a result of the procedures described above,

- the HP UPS Manager II Management Station is installed,
- the HP UPS Manager II client filesets are installed on each computer you want to define as an HP UPS Manager II managed or monitored node.

Next Steps

When you have completed the installation procedure in this chapter, you are ready to connect and configure your UPS devices. See *Chapter 4* (for HP PowerTrust UPS devices) or *Chapter 5* (for HP PowerManagement UPS devices) for detailed instructions.

Installing HP UPS Manager II on HP-UX Rev. 9 Systems
Next Steps

**Installing HP UPS Manager II on
HP-UX Rev. 10 Systems**

Installing HP UPS Manager II on HP-UX Rev. 10 Systems

To install HP UPS Manager II on systems running HP-UX rev. 10, you need to complete the following steps:

- Read the *Requirements* section below. Obtain your HP UPS Manager II code-word(s) and complete other preparatory steps.
- Install the appropriate HP UPS Manager II filesets on the HP UPS Manager II Management Station.
- Install the appropriate HP UPS Manager II filesets on each HP UPS Manager II managed node computer.

System Requirements

HP UPS Manager II Management Station Requirements

Hardware

The HP UPS Manager II Management Station has to be an HP 9000 Series 700 or Series 800 workstation (including at least 64 MB of memory, a graphics monitor, mouse and LAN card).

Disk Space Requirement

As a rule of thumb, HP UPS Manager II requires 33 MB of additional disk space for the HP UPS Manager II Management Station. The actual disk space requirement are governed by criteria such as the complexity of the networked cluster to be supported by HP UPS Manager II.

Operating System

The HP UPS Manager II Management Station requires HP-UX rev. 10.

Network

TCP/IP standard LAN.

HP UPS Manager II Managed/Monitored Node Computers

Hardware

Any HP 9000 series 700 or series 800 computer running the SNMP Master Agent module is supported as an HP UPS Manager II managed node computer. A graphic display monitor is recommended.

Other popular platforms, e.g. Novell network servers and Windows NT servers, are included in the portfolio of HP UPS Manager II managed node computers. See the current HP UPS Manager II datasheet for a complete list of supported clients and further details or contact your Hewlett-Packard sales representative.

Disk Space Requirements

As a rule of thumb, HP UPS Manager II requires 2 MB of additional disk space on each HP UPS Manager II managed node computer.

Installing HP UPS Manager II on HP-UX Rev. 10 Systems

System Requirements

Operating System

HP-UX rev. 9 or HP-UX rev. 10 operating system.

Network

TCP/IP standard LAN.

UPS Hardware

HP PowerManagement UPS or HP PowerTrust UPS. See the *HP PowerManagement Product Brief* for a current list of supported UPSs.

I. Preparation

Before you install HP UPS Manager II, be sure to complete the following preparatory steps:

- Obtain your HP UPS Manager II codeword(s)
- Complete other preparatory steps

Obtaining Your Codeword

On each HP UPS Manager II Management Station and/or Monitoring Station, you need to install a separate codeword for each UPS controlled or monitored by that station. A single license (plus associated codeword) is included in the scope of delivery of HP UPS Manager II. If you are not sure how many codewords you require for your configuration, refer to the *Licensing Policy* section in *Chapter 1* for guidance.

When requesting additional codewords, specify the LAN ID (MAC address) number of your HP UPS Manager II Management Station or Monitoring Station. Instructions for obtaining codewords are supplied on the Right-To-Use Certificate included in the HP UPS Manager II shipment package. The procedure for identifying this LAN ID number is described below.

NOTE:

If a given UPS is managed by HP UPS Manager II and monitored by UPS Manager II which runs in another segment of the network then you need **two** codewords for the same UPS: one for the Management Station and one for the Monitoring Station. (B4153A Option 001: License to use one UPS.)

Identifying the LAN ID of your HP UPS Manager II Management Station

Perform the following steps to find out the LAN station address of your HP UPS Manager II Management Station.

- 1 Log in as root on the HP 9000 Series 700 or Series 800 computer that you will set up as your HP UPS Manager II Management Station.
- 2 Enter the following command:

```
lanscan
```
- 3 Look under **Station Address** for your LAN station address (such as **0x080009...**). You need this LAN ID when requesting your HP UPS Man-

I. Preparation

ager II codeword(s).

- With your HP UPS Manager II Software, you received a license certificate for using HP UPS Manager II with a single UPS. Optionally, you can order additional certificates (B4153A Option 001: License to use one UPS) to manage and/or monitor multiple UPS devices with HP UPS Manager.
- The license certificate describes all steps required for obtaining a codeword.
- Record the codewords and/or store the codewords in a file. *Be sure to store your codewords in a safe place. Without your codeword(s), you cannot use HP UPS Manager II to manage and/or monitor UPS devices.*

The codeword installation procedure is described later in this chapter.

Additional Preparatory Steps

Asks your system administrator to obtain the IP addresses of your UPS(s).

Next Steps

You are now ready to install HP UPS Manager II.

II. Software Installation Procedure

The installation of the HP UPS Manager II software comprises the following stages:

- 1** Setting up the Netdist server and copying the HP UPS Manager II filesets from the installation medium to disk
- 2** Setting up the HP UPS Manager II Management Station plus database
- 3** Installing your HP UPS Manager II codeword(s)
- 4** Copying the HP UPS Manager II Client filesets to each HP UPS Manager II managed node computer

Detailed instructions for each stage are provided on the following pages.

Stage 1: Copying the HP UPS Manager II Filesets to Disk

On the computer you want to use as your Netdist Server and your HP UPS Manager II Management Station, proceed as follows to copy the HP UPS Manager II filesets from the installation medium to your hard disk:

- 1** Insert the HP UPS Manager II installation medium into the drive.
- 2** Specify the following command (in single-user mode) to install HP UPS Manager II:

`swinstall`
- 3** In the Specify Source panel displayed by the system, specify the name of the installation computer as the source host name.
- 4** Specify the name of the installation drive as the source depot path. Sample entries for the Specify Source panel are shown below.

II. Software Installation Procedure

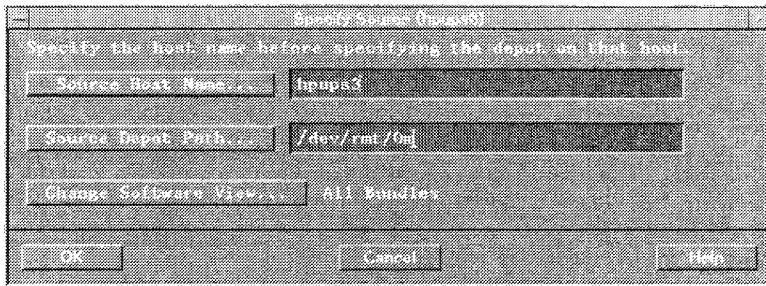

Figure 3-1

Specify Source - Sample Entries

- 5 Click OK. The system returns a bundles-related information panel. Click OK. The system returns the Software Selection panel.

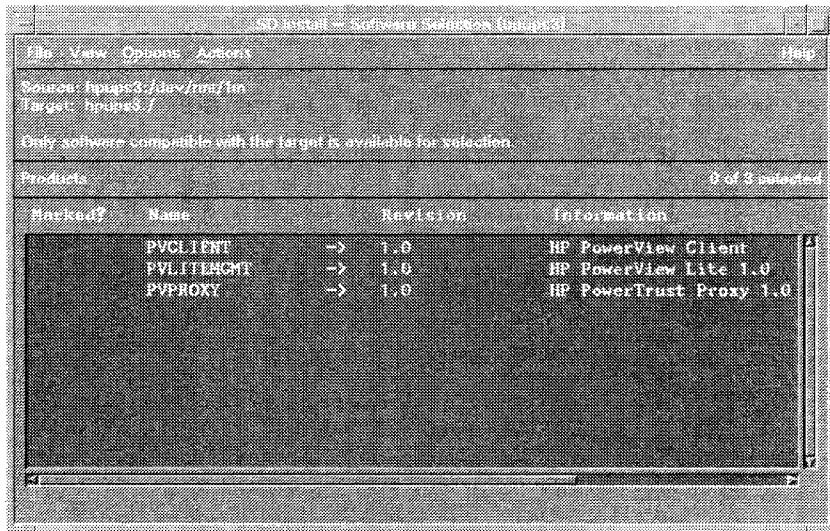

Figure 3-2

Software Selection

- 6 Hold down the CTRL key and use the left mouse button to select the following filesets:

II. Software Installation Procedure

PVCLIENT
 PVLITEMGMT
 PVPROXY (if using HP PowerTrust UPS systems)

7 Pull down the Actions menu and select:

Mark for Install

8 The Marked? column is now set to Yes for the filesets you selected.

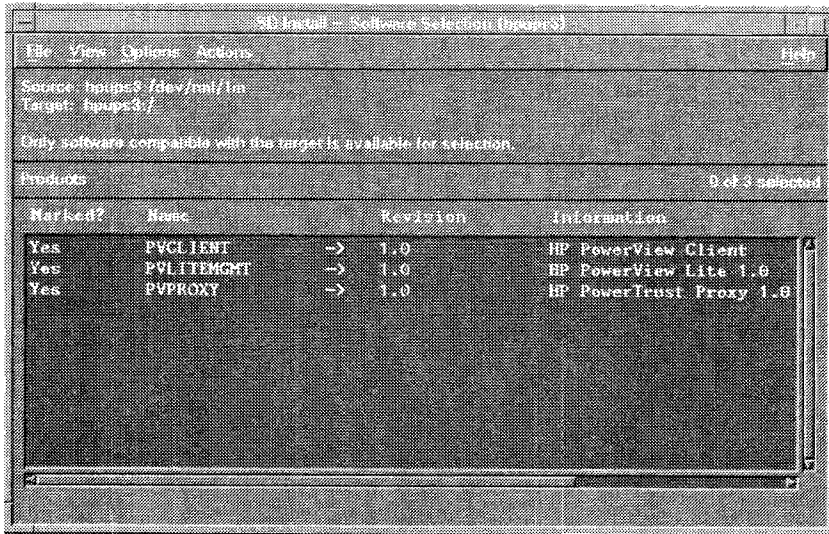

Figure 3-3

Marked? Yes

9 Pull down the Actions menu and select the following menu item to install the marked filesets:

Install Analysis

10 The system returns the following panel:

II. Software Installation Procedure

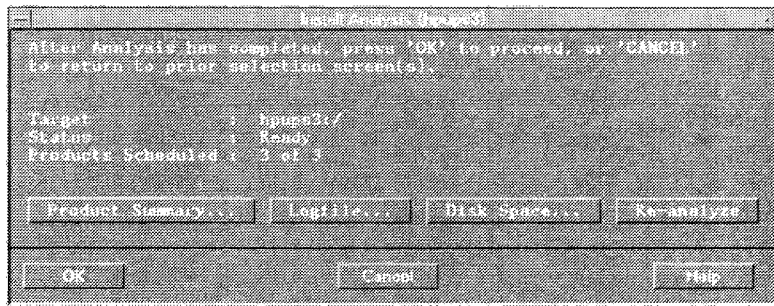

Figure 3-4

Install Analysis

11 Click OK to display the following panel:

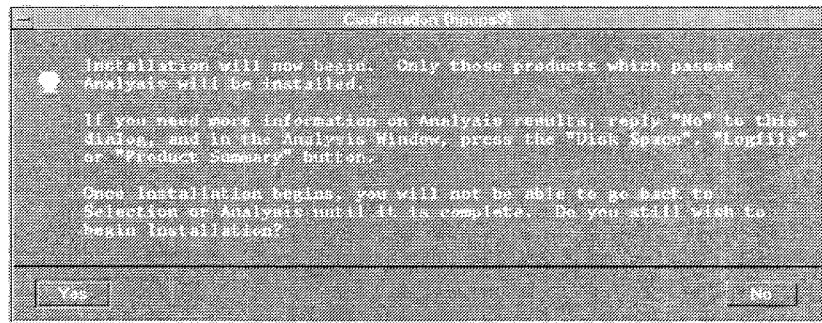
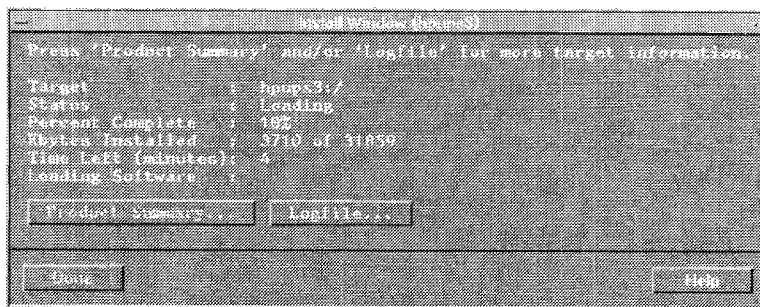

Figure 3-5

Confirmation

12 Read the instructions in this panel. Click Yes to continue.

13 The progress of the installation is displayed in the following panel.

**Figure 3-6****Installation Progress**

14 Upon completion of the installation process, click Done.

15 To exit swinstall, select File -> Exit .

Stage 2: Setting up the HP UPS Manager II Management Station plus Database

Proceed as follows to set up the HP UPS Manager II Management Station:

1 Enter the following command:

```
/usr/pv-lite/bin/pvlinstall
```

This command:

- creates the HP UPS Manager II database;
- generates default values for alarm configuration;
- starts the UPS monitor daemon.
- prompts you to set up a support user. This optional procedure will add a group named pvsupport and a user named powerview to the file /etc/group and an entry to the file /etc/passwd. The group of all installed files changes to powerview. The database permissions are set to read and write for user and group.

While this command executes, the system returns a series of progress messages and prompts. Upon completion of this command, your first UPS management or monitoring link is licensed. For any additional management and/or monitoring links, you can install additional HP UPS Manager II codewords as described below.

II. Software Installation Procedure

Stage 3: Installing Additional HP UPS Manager II Codeword(s)

Proceed as follows to install your HP UPS Manager codeword(s):

- 1 For each HP UPS Manager II UPS license you want to use in addition to the first license (see *Licensing Policy* in *Chapter 1*), enter the following command on the HP UPS Manager II Management Station:

```
/usr/pvlight/bin/pvkey
```

- 2 When prompted to add a new license, press Y.
- 3 When prompted, enter the IP address for the UPS device for which you want to install a codeword. For HP PowerTrust devices, this is the IP address of the workstation where the proxy agent is running. For HP PowerManagement UPS devices, this is the IP address of the SNMP port to which you will connect the UPS device.
- 4 When prompted, enter the certificate serial number of your HP UPS Manager II Right-to-Use Certificate. This serial number is specified in the header of your HP UPS Manager II Right-to-Use certificate.
- 5 When prompted, enter the codeword you obtained (as described above) for your HP UPS Manager II Management Station
- 6 Repeat this codeword installation procedure for any workstation(s) you want to set up as an HP UPS Manager II Monitoring Station(s). When prompted, press Y for any additional license you want to install or N if you do not want to install a license for the associated workstation. If you are not sure what to do, refer to the *Licensing Policy* section in *Chapter 1*.
- 7 To verify that HP UPS Manager II has been installed properly on the Management Station, enter the following command:

```
/usr/pvlight/bin/pvmap &
```

This command starts HP UPS Manager II and displays the UPS Domain Map. This map is initially empty because no UPS has yet been added to the map.

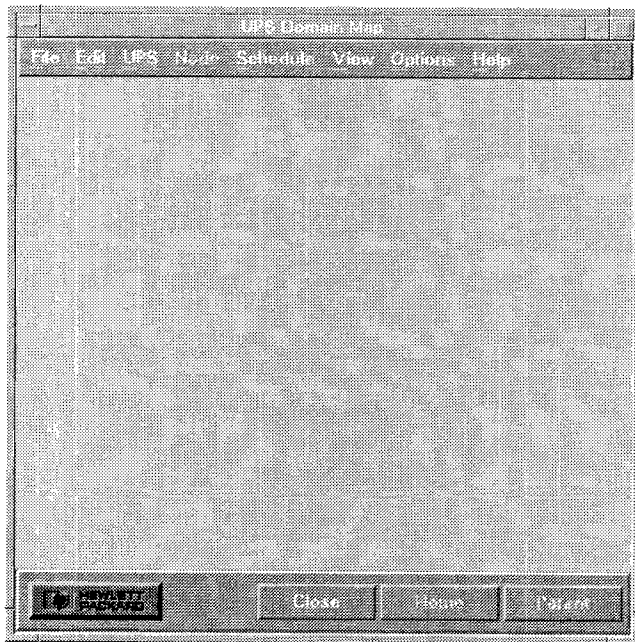

Figure 3-7

HP UPS Manager II - Empty UPS Domain Map

The entire functionality of HP UPS Manager II is accessible from this window.

Stage 4: Installing the HP UPS Manager II Client Filesets on each Managed Node Computer

NOTE:

This procedure needs to be performed on each computer which is to be UPS protected and managed and/or monitored by the HP UPS Manager II Management Station. Remember that you have already installed the PVCLIENT fileset on your Management Station. Therefore, you do **not** need to repeat this procedure on your Management Station.

Proceed as follows to install the appropriate HP UPS Manager II client filesets on each computer you want to manage or monitor from the HP UPS Manager II.

- 1 Start swinstall.
- 2 In the Specify Source panel returned by the system, specify the source depot path. This is the target you specified in Stage 1.

II. Software Installation Procedure

- 3 Click **OK**. The system returns the Software Selection panel.
- 4 Select the PVCLIENT fileset.
- 5 Pull down the Actions menu and select:
Mark for Install
- 6 Pull down the Actions menu and select the following menu item to install the PVIEW_CLIENT fileset:
Install Analysis
- 7 The system returns the Install Analysis panel. Click **OK** to display the Confirmation panel.
- 8 Read the instructions in this panel. Click **Yes** to continue.
- 9 Upon completion of the installation process, click **Done**.

Results of the Installation and Configuration Procedure

As a result of the procedures described above,

- the HP UPS Manager II Management Station is installed,
 - the HP UPS Manager II client filesets are installed on each computer you want to define as an HP UPS Manager II managed or monitored node.
-

Next Steps

When you have completed the installation procedure in this chapter, you are ready to connect and configure your UPS devices. See *Chapter 4* (for HP PowerTrust UPS devices) or *Chapter 5* (for HP PowerManagement UPS devices) for detailed instructions.

Installing HP UPS Manager II on HP-UX Rev. 10 Systems
Next Steps

**Connecting and Configuring
HP PowerTrust UPS Devices**

Connecting and Configuring HP PowerTrust UPS Devices

When you have completed the installation instructions Chapter 2 (for HP-UX rev. 9) or *Chapter 3* (for HP-UX rev. 10), you are ready to connect and configure your HP PowerManagement UPS devices. This procedure includes the following steps:

- Connecting each UPS device to a suitable AC power outlet.
- Connecting the individual HP UPS Manager II managed nodes to their associated UPS device(s).
- Installing and configuring the proxy agent.

Connecting HP PowerTrust UPS Devices

Connect your UPS devices to a suitable AC outlet and to your network as described in the product documentation you received with your UPS devices.

Simple Scenario: Single Computer, Single UPS

If you want to provide UPS protection to a single computer (running HP-UX and doubling as the HP UPS Manager II Management Station), you have to establish a serial RS232 connection from the HP PowerTrust UPS to this computer. Then you follow the instructions provided later in this chapter for installing the proxy agent on the same computer.

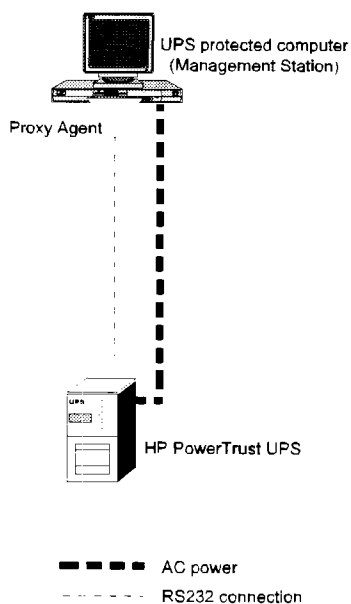

Figure 4-1

Single Computer, Single UPS

The scenario shown above requires a single codeword. See the *Licensing Policy* section in *Chapter 1*.

Connecting and Configuring HP PowerTrust UPS Devices
Connecting HP PowerTrust UPS Devices

Simple Scenario: Two Computers, Single UPS

If you want to provide UPS protection to two computers sharing the same HP PowerTrust UPS, you have to establish a serial RS232 connection from the UPS to one of these computers (running HP-UX; ideally, this should be the HP UPS Manager II Management Station). Then you install the proxy agent on the computer which is RS232 connected to the UPS. In addition, you need to make sure that there is a network connection between both computers.

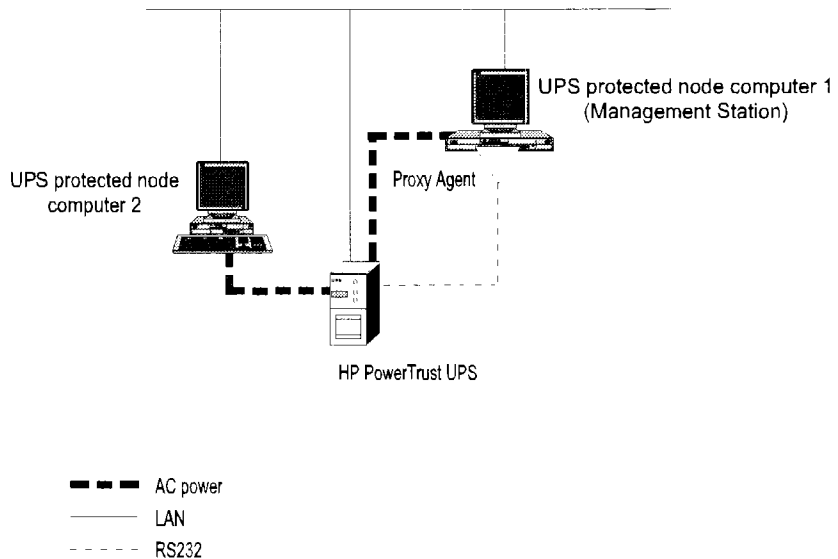

Figure 4-2 Two Computers, Single UPS

The scenario shown above requires a single codeword. Remember that one codeword is supplied with HP UPS Manager II. See the *Licensing Policy* section in *Chapter 1*.

Complex Scenario: Distributed Client/Server Environment

If you want to provide UPS protection to a more complex environment, you have to establish a serial RS232 connection from each UPS to a computer (running HP-UX) on which you will run the proxy agent. Then you install the proxy agent on the computers which are RS232 connected to the UPSs in each local cluster.

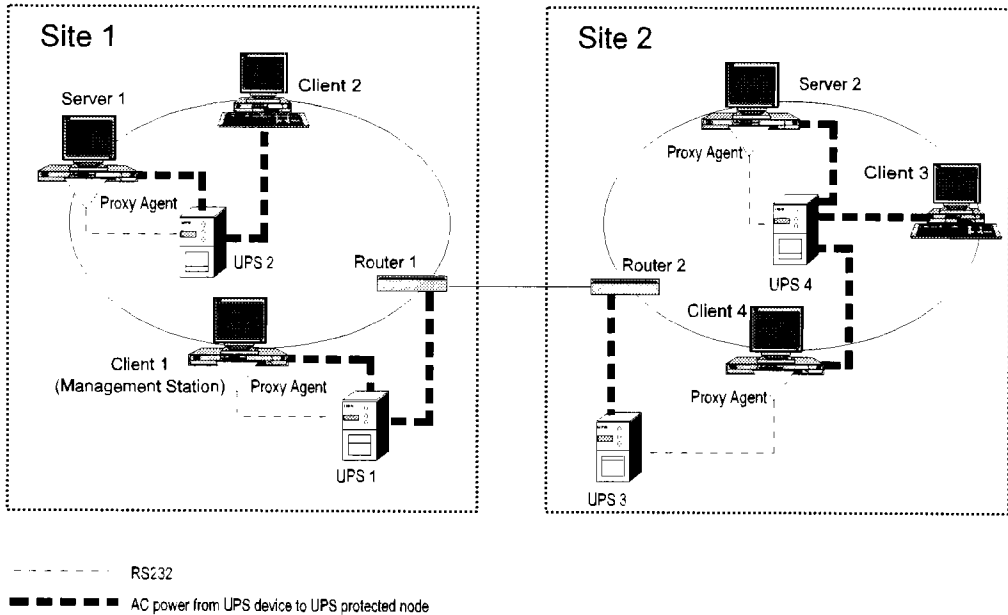

Figure 4-3 Distributed Client/Server Environment

The scenario shown above requires four codewords: the codeword you received with HP UPS Manager II plus three additional codewords. See the *Licensing Policy* section in *Chapter 1*.

Installing and Setting Up the Proxy Agent for HP PowerTrust UPS Devices

The proxy agent for HP PowerTrust UPS devices emulates an SNMP interface (see *Chapter 5*) between the HP PowerTrust UPS system and the TCP/IP network. This proxy agent translates the UPS commands to SNMP UPS-MIB commands. HP PowerTrust UPS devices therefore need a direct RS232 connection to the computer where the proxy agent runs.

Proceed as follows to configure an HP PowerTrust UPS device for a computer you want to protect with HP UPS Manager II:

- 1 Shut down the computer (shutdown -h -y 0) and disconnect the computer from its AC power source.
- 2 Connect the power cable of the computer to an AC power outlet of the UPS.
- 3 Use the RS232 cable supplied with the UPS to create a serial connection between the computer and the UPS.
- 4 Enter the following command to set up the proxy agent:

```
/usr/pvproxy/setup
```

- 5 When prompted, enter the device name (e.g. /dev/tty0p0) of the serial interface connected to the HP PowerTrust UPS.

NOTE:

You can use `ioscan -fn` (for HP-UX rev. 10 only) or `ioscan` and other options (for HP-UX rev. 9) to find out the correct device file and driver names.

After the next startup of HP UPS Manager II, the proxy agent will start up automatically.

- 6 HP UPS Manager II automatically identifies the proxy agent as an HP UPS device and displays an associated special icon.

Result

As a result of the procedures described above, the proxy agent is installed on a computer having a serial RS232 connection to the UPS. The associated HP PowerTrust UPS devices are ready for use.

Next Steps

When you have connected and configured your HP PowerTrust UPS device(s), you are ready to add the first UPS to the UPS domain map and to allocate a UPS protected node computer to it. This procedure is described in *Chapter 6*.

Connecting and Configuring HP PowerTrust UPS Devices

Next Steps

**Connecting and Configuring
HP PowerManagement UPS Devices**

Connecting and Configuring HP PowerManagement UPS Devices

When you have completed the installation instructions in *Chapter 2* (for HP-UX rev. 9) or *Chapter 3* (for HP-UX rev. 10), you are ready to connect and configure your HP PowerManagement UPS devices. This procedure includes the following steps:

- Connecting each UPS device to a suitable AC power outlet.
- Connecting each UPS device to the network.
- Connecting each UPS device to its associated SNMP interface module.
- Connecting the individual HP UPS Manager II managed nodes to their associated UPS device(s).

Connecting HP PowerManagement UPS Devices

Connect your UPS devices to a suitable AC outlet and to your network as described in the product documentation you received with your UPS devices. Then shut down the computers (shutdown -h -y 0) you want to provide with UPS protection and disconnect the computers from their AC power source. Connect each computer (and other equipment for which you want to ensure UPS protection) to its associated UPS.

HP PowerManagement UPS devices are supplied with a separate SNMP interface module supporting multiple SNMP agents. This SNMP interface module allows multiple UPS devices to be controlled by your HP UPS Manager II Management Station. Your HP UPS Manager II SNMP interface modules feature four ports for this purpose.

Simple Scenario: Single Computer, Single UPS

If you want to provide UPS protection to a single computer (doubling as the HP UPS Manager II Management Station), you have to establish a connection from the SNMP interface module to that workstation and from the SNMP interface module to the UPS. The scenario shown below requires a single codeword. Remember that one codeword is supplied with HP UPS Manager II. See the *Licensing Policy* section in *Chapter 1*.

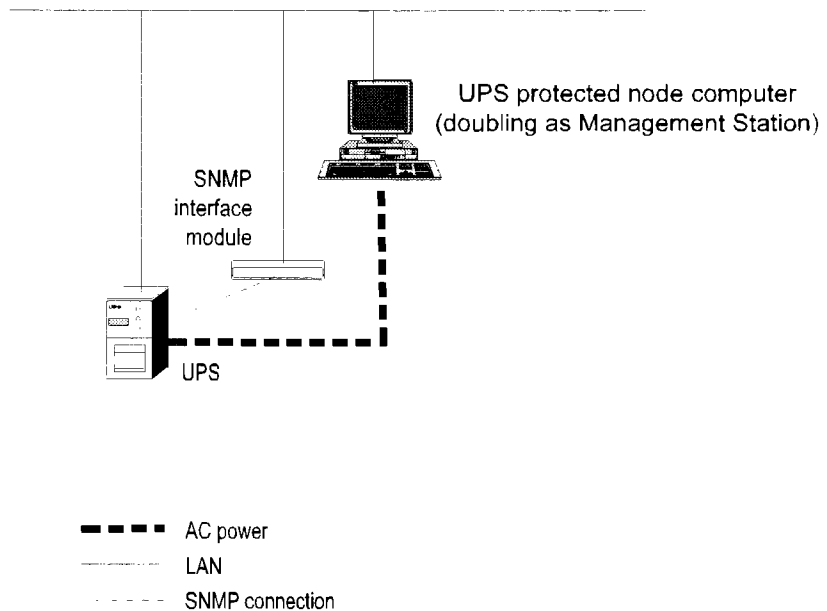

Figure 5-1 **Single Computer, Single UPS**

Simple Scenario: Two Computers, Single UPS

If you want to provide UPS protection to two computers sharing the same UPS, you have to establish a connection from the SNMP interface module to the computer serving as the HP UPS Manager II Management Station. In addition, you need to make sure that there is a network connection between both computers.

The scenario shown below requires a single codeword. Remember that one codeword is supplied with HP UPS Manager II. See the *Licensing Policy* section in *Chapter 1*.

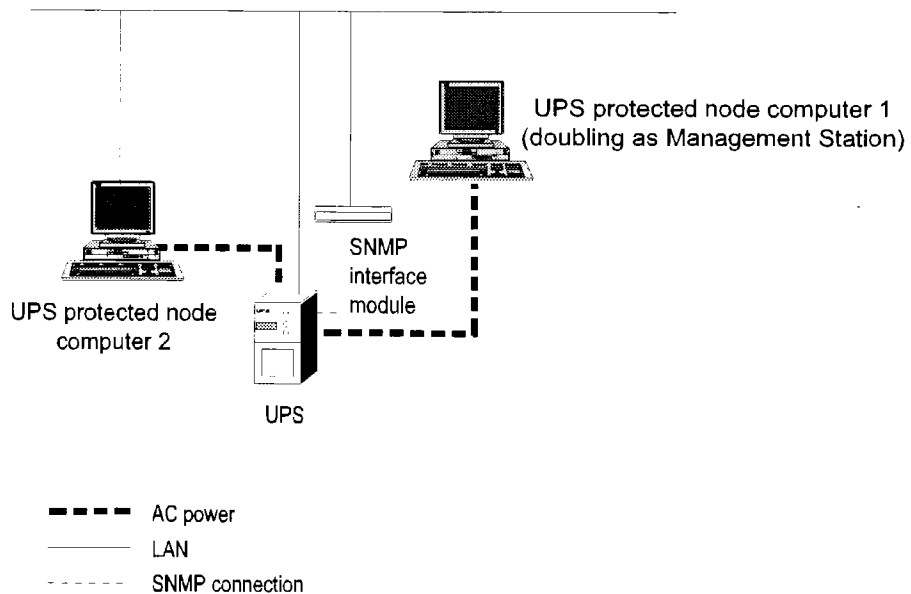

Figure 5-2 Two Computers, Single UPS

Complex Scenario: Distributed Client/Server Environment

If you want to provide UPS protection to a more complex environment, you have to establish a logical connection from the SNMP interface module to the UPS Manager II Management Station and from the SNMP interface module to a maximum of four UPSs. The scenario shown below requires five codewords: one codeword supplied with HP UPS Manager II plus four additional codewords. See the *Licensing Policy* section in *Chapter 1*.

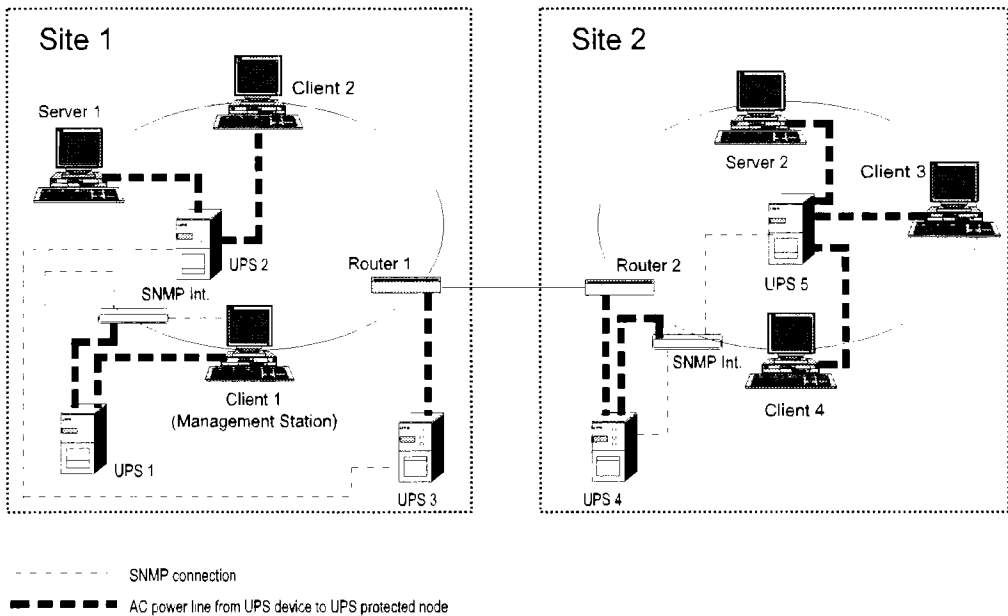

Figure 5-3 Distributed Client/Server Environment

Configuring SNMP Interface Modules for HP PowerManagement UPS Devices

The SNMP interface module enables HP UPS Manager II to poll for UPS devices in your network.

The following figure illustrates the logical links between each UPS, its associated SNMP agent on the SNMP interface, and the HP UPS Manager II Management Station.

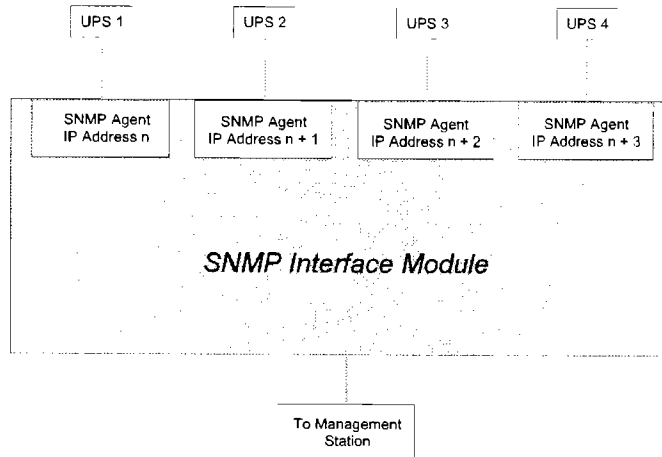

Figure 5-4

SNMP Interface for Multiple UPS Devices

Preparatory Steps

Before you begin to configure your SNMP interface module, be sure to obtain the following information from your site network administrator:

- The hardware address of your SNMP interface module.
- The IP addresses for your SNMP interface modules. When obtaining these addresses, be aware of the fact that the first IP address you specify in the procedure outlined below will be automatically incremented to define the IP addresses of the other ports on your SNMP interface module. This process is illustrated in the

Connecting and Configuring HP PowerManagement UPS Devices
Configuring SNMP Interface Modules for HP PowerManagement UPS Devices

figure above.

- The gateway address of your SNMP interface module.
- The netmask address of your SNMP interface module.

Be sure that this information is available to you before you commence the following procedure.

Procedure

Proceed as follows to configure your SNMP interface module:

- 1 Reset your SNMP module.
- 2 In the window shown in Figure 2-1, pull down the Options menu.
- 3 From the Options menu, select UPS Interface Config. to display the following panel:

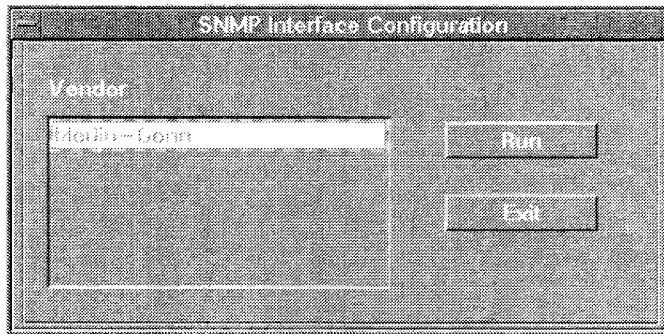

Figure 5-5

UPS Vendor Panel

- 4 Select the appropriate UPS vendor name (such as Merlin-Gerin) from this panel.
- 5 Click on Run. The system returns a vendor-specific panel for entering the hardware address of your SNMP interface module.
- 6 Specify the (hexadecimal) hardware address of your SNMP interface module. This address is usually specified on a label attached to the bottom of your SNMP interface module. A "dummy" sample hardware address is shown in the following figure.

Connecting and Configuring HP PowerManagement UPS Devices
Configuring SNMP Interface Modules for HP PowerManagement UPS Devices

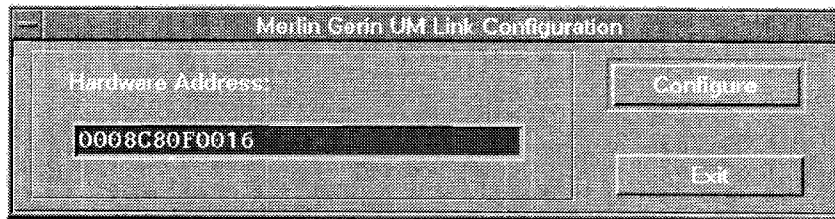

Figure 5-6 **Sample Hardware Address**

- 7 Click on Configure to display a vendor-specific SNMP Module Configuration Parameters panel linked to the hardware address you specified above.

NOTE:

Depending on the make/model of your SNMP interface module, the hardware address may be specified on a printed label attached to the bottom of the module. If this is not the case, you have to use a terminal connected to COM1 port of the SNMP Interface. Please follow the instructions in the SNMP Interface Handbook (UM Link, SNMP Adapter) Chapter 4: Using Terminal Program. This handbook is delivered with your SNMP Interface.

- 8 In the IP Address #1 field of this panel, specify the IP address of the first UPS communication port of your SNMP interface module. The three other UPS communication ports will automatically receive incrementally higher IP addresses as illustrated in the figure above. For example, if the IP address of the first UPS port is 168.8.255.48, the second UPS port automatically receives IP address 168.8.255.49 and so forth.
- 9 Specify the gateway. This is often 0.0.0.0.
- 10 Specify the netmask. This is typically 255.255.255.0.
- 11 Specify the community. For security reasons you may choose another community by using the direct terminal port (COM1) and VT100 Terminal. Please follow the procedure outlined in the manual supplied with your SNMP Interface Module. The default value is public. Make sure that the community name of the SNMP Interface and the UPS manager community configured with the HP UPS Manager II menu item for for PORT configuration are the same.

A sample SNMP interface configuration parameters panel is shown below.

Connecting and Configuring HP PowerManagement UPS Devices
Configuring SNMP Interface Modules for HP PowerManagement UPS Devices

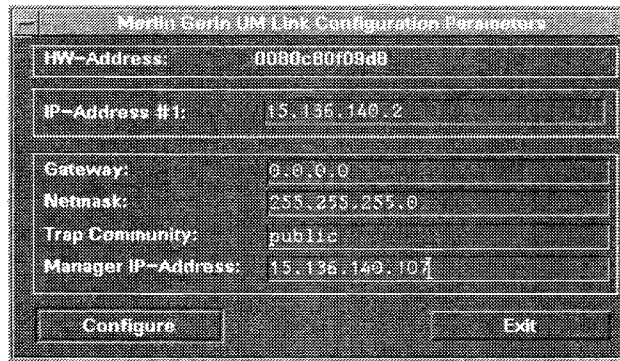

Figure 5-7 SNMP Interface Configuration Parameters Panel

- 12 Click on Configure to apply the configuration parameters for your SNMP interface module.
- 13 The system returns a separate confirmation panel. Review this panel.

NOTE:

You can retain the "public" setting or you can use a terminal emulator to change the write community of COM1 of the SNMP interface module.

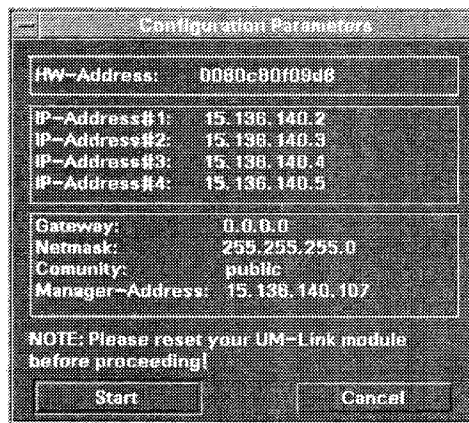

Figure 5-8 SNMP Interface Configuration Parameters Panel - Confirmation

Connecting and Configuring HP PowerManagement UPS Devices
Configuring SNMP Interface Modules for HP PowerManagement UPS Devices

- 14 Click Start to display the Progress window.

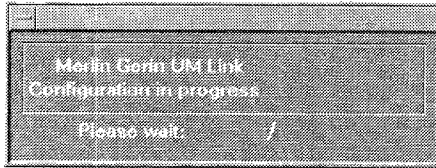

Figure 5-9

Progress

- 15 Upon completion, the system returns the following confirmation window.

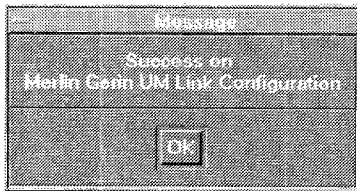

Figure 5-10

Confirmation

- 16 This procedure needs to be repeated for each SNMP interface module in your network.

The system automatically saves the SNMP interface information to a file in the appropriate directory:

```
/usr/pvllite/log
```

The name of this file reflects the hardware address of your SNMP interface. A sample file is shown below.

```
PLEASE KEEP THIS INFORMATION !
IT MAY BE USED IN CASE OF A HARDWARE EXCHANGE OF SNMP-MODULE
IP-Address COM 1:          15.136.140.2
IP-Address COM 2 (automatic): 15.136.140.3
IP-Address COM 3 (automatic): 15.136.140.4
IP-Address COM 4 (automatic): 15.136.140.5
Gateway:                   0.0.0.0
Netmask:                   255.255.255.0
Trap Community:            public
Manager IP-address:        15.136.140.222
SNMP module configured at : Fri Sep 13 10:01:23 METDST 1996
```

Connecting and Configuring HP PowerManagement UPS Devices
Configuring SNMP Interface Modules for HP PowerManagement UPS Devices

NOTE:

For each subsequent configuration, you need to reset the SNMP interface module by pressing its reset button or by briefly disconnecting it from its power supply.

CAUTION:

Be sure to provide each SNMP interface module with adequate UPS protection.

Result

As a result of the procedures described above, the SNMP interface modules(s) and their associated HP PowerManagement UPS devices are ready for use.

Next Steps

When you have connected and configured your HP PowerManagement UPS device(s) and their associated SNMP interface modules as described in this chapter, you are ready to add the first UPS to the UPS domain map and to allocate a UPS protected node computer to it. This procedure is described in *Chapter 6*.

Connecting and Configuring HP PowerManagement UPS Devices
Next Steps

**Adding the First UPS to the UPS
Domain Map and Assigning a UPS
Protected Node Computer**

Adding the First UPS to the UPS Domain Map and Assigning a UPS Protected Node Computer

Upon completion of the procedures described in *Chapter 2* (if you are using HP-UX rev. 9) or *Chapter 3* (if you are using HP-UX rev. 10) and *Chapter 4* (for HP PowerTrust UPS devices) or *Chapter 5* (for HP PowerManagement UPS devices), you are ready to add the first UPS to the UPS Domain Map. This UPS should ideally be connected to the HP UPS Manager II Management Station. The following exercise will provide you with useful hands-on experience.

The procedure consists of the following stages:

- 1 Adding the UPS to the UPS Domain Map
- 2 Configuring the UPS
- 3 Defining a computer as a UPS dependent node
- 4 Configuring the UPS dependent node
- 5 Verifying the community of the UPS dependent node
- 6 Test

Stage 1: Adding the UPS to the UPS Domain Map

Proceed as follows to add a UPS to the UPS Domain Map.

- 1 From the HP UPS Manager III UPS Domain Map you saw during Stage 3 of the installation procedure, pull down the UPS menu and select Add to display the following panel.

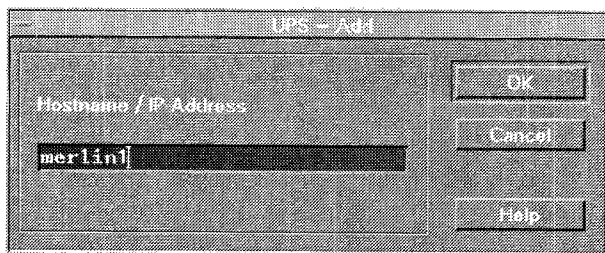

Figure 6-1

Adding a UPS

- 2 Specify the hostname or IP address of the UPS you want to add. Then click OK to confirm. The UPS Domain Map now displays a yellow icon for the UPS you just added.

Adding the First UPS to the UPS Domain Map and Assigning a UPS Protected Node Computer

Stage 1: Adding the UPS to the UPS Domain Map

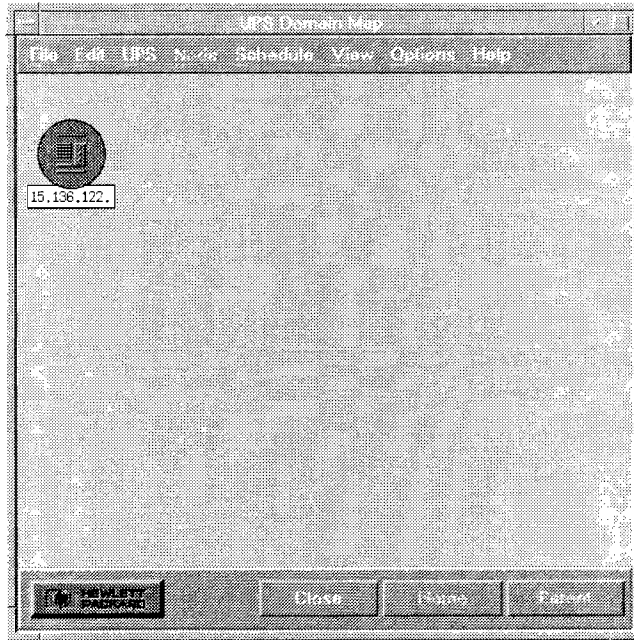

Figure 6-2 New UPS Icon in UPS Domain Map

- 3 Unless this newly added UPS is your first UPS (for which the codeword will be installed automatically), a window such as the following example prompts you for the appropriate certificate serial number plus codeword:

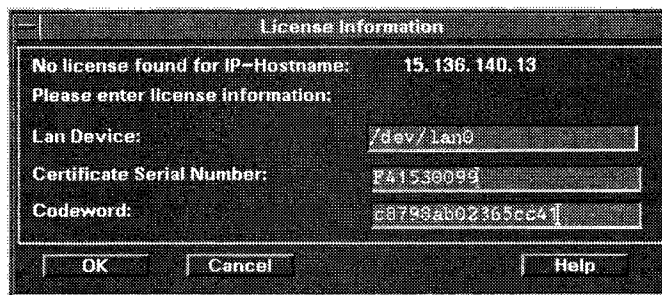

Figure 6-3 Sample License Information

Stage 1: Adding the UPS to the UPS Domain Map

- 4 Fill in the required data and then click OK. If any of your entries are invalid, the system returns the following message box:

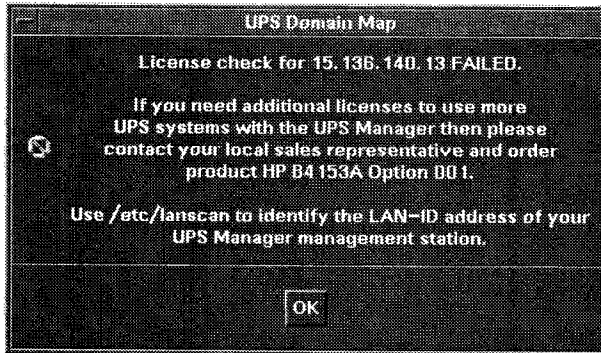

Figure 6-4

License Data Error Message

- 5 Make sure that your entries are correct. Upon successful completion of this procedure, the system returns a message confirming the validity of your licensing entries.
- 6 As soon as the UPS icon in the UPS Domain Map turns green, start the HP UPS Manager II client process by entering the following in a separate window:

```
/usr/pvclient/pvclient &
```
- 7 The system returns an amber traffic light because the workstation (your HP UPS Manager II Management Station) has not yet been assigned to the newly added UPS.

Adding the First UPS to the UPS Domain Map and Assigning a UPS Protected Node Computer

Stage 1: Adding the UPS to the UPS Domain Map

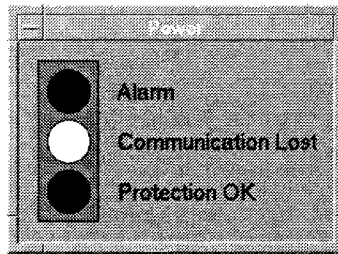

Figure 6-5

Amber Traffic Light

Stage 2: Configuring the UPS

When the icon associated with your UPS has turned green, you are ready to configure the UPS.

NOTE:

Please note that the following configuration steps are intended as a first "look" at the HP UPS Manager II configuration capabilities. For a detailed description, refer to *Chapter 9*.

Proceed as follows to configure your UPS.

- 1 In the UPS Domain Map, select the icon of the UPS you want to configure.
- 2 From the UPS Domain Map, pull down the UPS menu and select Configure to display the following panel.

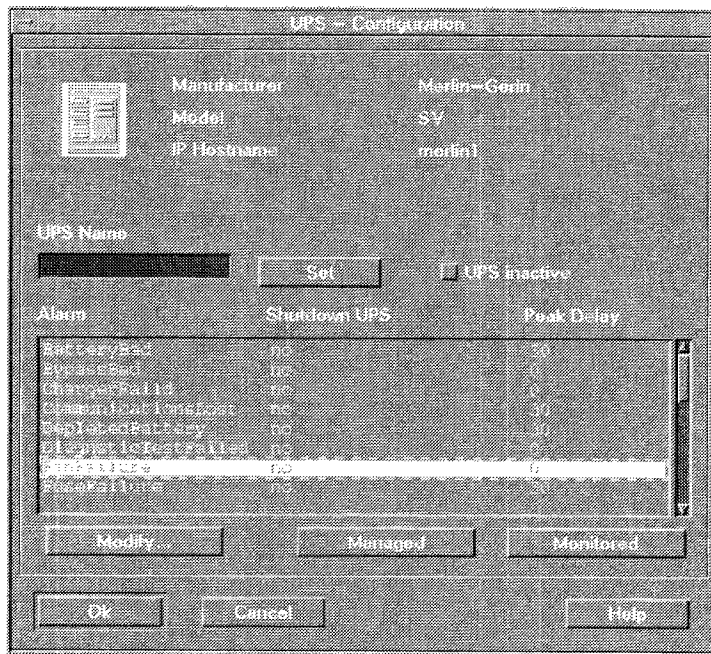

Figure 6-6

UPS Configuration

Adding the First UPS to the UPS Domain Map and Assigning a UPS Protected Node Computer

Stage 2: Configuring the UPS

- 3 This panel enables you to define the alarm handling of the newly added UPS. Familiarize yourself with the default settings for each alarm condition. For a detailed description of alarm handling capabilities, refer to *Chapter 11*. For your first exercise, it may be a good idea to retain the default settings.
- 4 Click on *Managed* to define the newly added UPS as a *managed* (as opposed to *monitored*) node. This implies that the newly added UPS will use the defaults for HP UPS Manager II *managed* nodes.
- 5 Click OK.

You are now ready to assign a computer to your newly added UPS. Make sure that the AC plug of this computer is connected to the UPS and that the UPS is running.

Stage 3: Defining a Computer as a UPS Dependent Node

Proceed as follows to assign a computer to the UPS you just added to the UPS Domain Map.

- 1 Select a UPS device.
- 2 Pull down the UPS menu and select Dependencies to display the following (containing a sample entry for illustration purposes) or a similar panel.

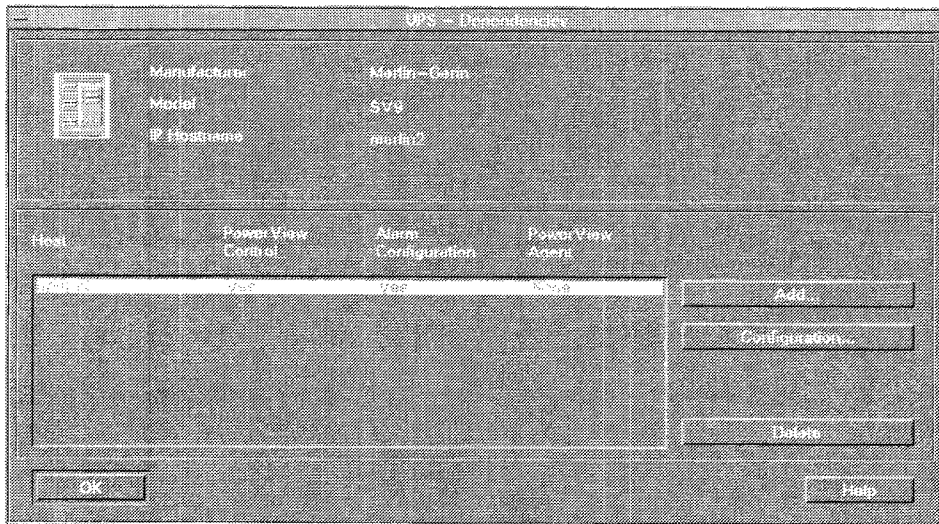

Figure 6-7

UPS Dependencies

- 3 In the panel shown above, click on Add to display the following panel:

Adding the First UPS to the UPS Domain Map and Assigning a UPS Protected Node Computer

Stage 3: Defining a Computer as a UPS Dependent Node

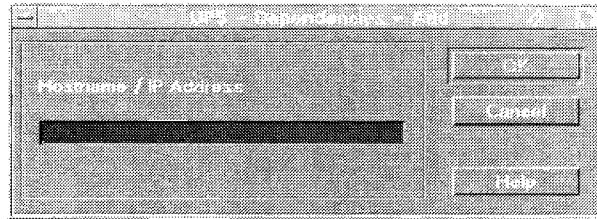

Figure 6-8 UPS Dependencies - Add Node

- 4 Specify the hostname or the IP address of the computer you want to assign to the UPS.
- 5 Confirm your entry by clicking OK. The computer is now assigned to the UPS. The newly added node is now listed in the appropriate panel.

NOTE: If you specify a trap client (such as a PC), please remember that this UPS protected node computer cannot execute any UPS II Manager controlled actions

NOTE: If you specify an invalid node name, the system returns an error message.

- 6 Click on OK. A new icon representing your workstation as a UPS dependent node is displayed in the UPS Segment Map.

Adding the First UPS to the UPS Domain Map and Assigning a UPS Protected Node Computer
Stage 3: Defining a Computer as a UPS Dependent Node

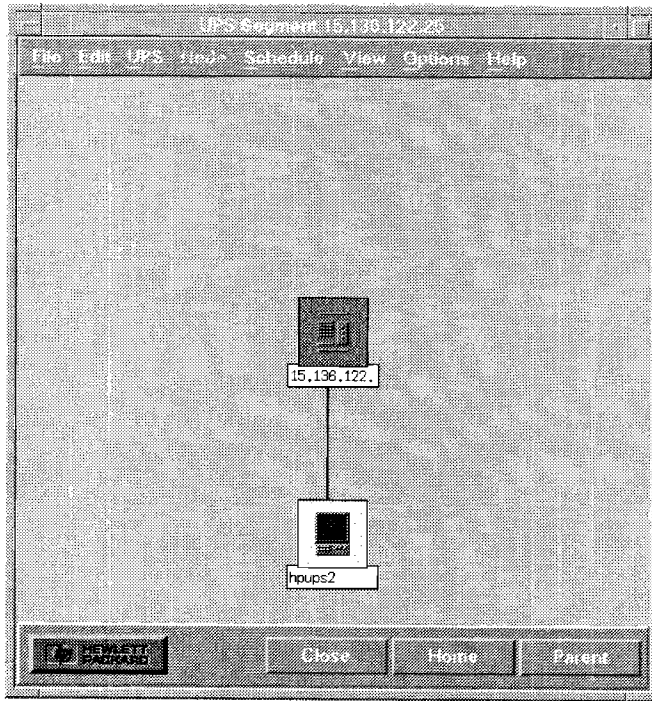

Figure 6-9 New UPS Protected Node Icon in UPS Domain Map

- 7 Upon completion of the node polling interval (see *Chapter 8*), the icon representing your newly added UPS dependent node turns green. To accelerate this process, you can run `/usr/pvlight/bin/pvlstop` to stop the background process and then `/usr/pvlight/bin/pvlstart` to restart the background process. At the same time, the traffic light displayed on your workstation screen turns green.

Adding the First UPS to the UPS Domain Map and Assigning a UPS Protected Node Computer

Stage 3: Defining a Computer as a UPS Dependent Node

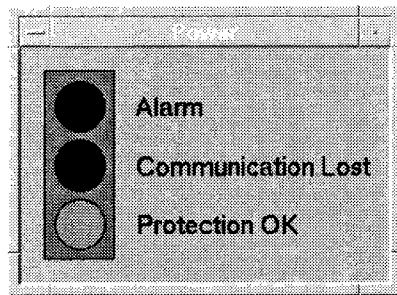

Figure 6-10

Green Traffic Light

Stage 4: Configuring the UPS Dependent Node Computer

When the icon associated with your UPS dependent node computer has turned green, you are ready to configure the UPS dependent node.

NOTE:

Please note that the following configuration steps are intended as a first "look" at the HP UPS Manager II configuration capabilities. For a detailed description, refer to *Chapter 11*.

Proceed as follows.

- 1** In the UPS Segment Map, highlight the icon associated with the UPS dependent node computer.
- 2** Pull down the Node menu and click on Configuration to display the following panel.

Adding the First UPS to the UPS Domain Map and Assigning a UPS Protected Node Computer

Stage 4: Configuring the UPS Dependent Node Computer

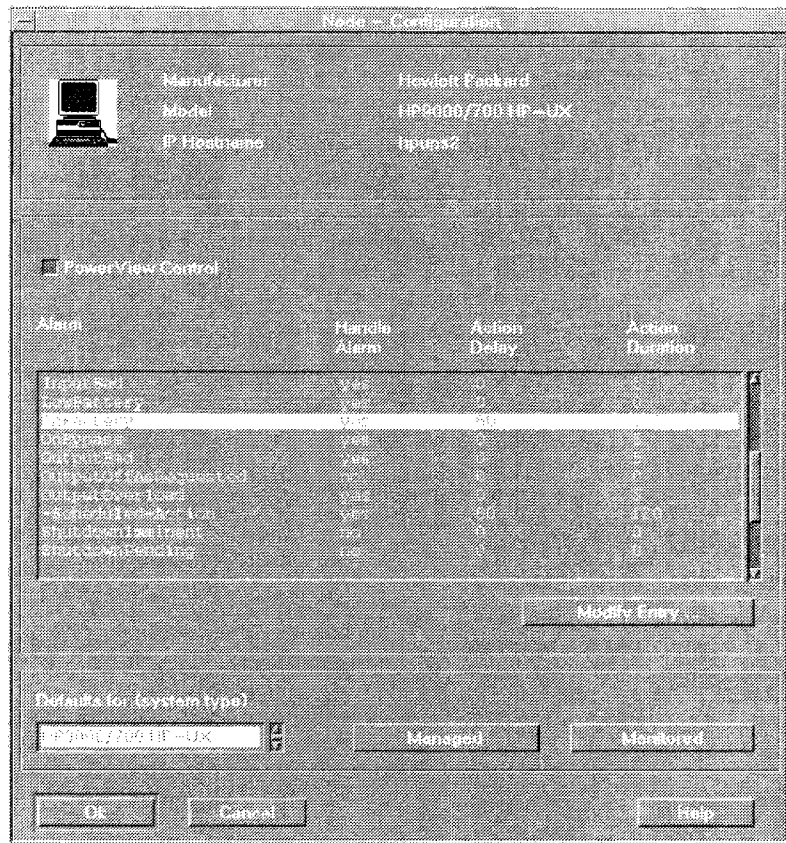

Figure 6-11 Node Configuration

- 3 This panel enables you to define the alarm handling of the computer you want to assign (as a dependent node) to the UPS. Familiarize yourself with the default settings for each alarm condition. For a detailed description of alarm handling capabilities, refer to *Chapter 11*. For your first exercise, it may be a good idea to retain the default settings.
- 4 Click on **Managed** to define the newly assigned computer as a *managed* (as opposed to *monitored*) node. This implies that the newly assigned computer will use the defaults for HP UPS Manager II *managed* nodes.
- 5 Click **OK**.

Stage 5: Verifying the Community of the UPS Dependent Node

To ensure UPS protection for your UPS dependent node computer, you need to make sure that its community matches the HP UPS Manager II community. Proceed as follows:

- 1 In the UPS Segment Map, highlight the icon associated with the UPS dependent node computer.
- 2 Pull down the Options menu and select SNMP Configuration.
- 3 Verify that the community of your UPS dependent node is the same as in the following file:

```
/etc/snmpd.conf
```

This file contains the following settings:

```
get-community-name: public  
set-community-name: powerview
```



Stage 6: Test

Stage 6: Test

When you have completed the previous stages, it may be a good idea to test your UPS protection. During the test, you will simulate an AC line power failure by disconnecting the UPS from its AC power receptacle.

NOTE:

If you reconnect the UPS AC power plug to its receptacle within the action delay time (i.e., in 60 seconds or earlier), the shutdown action described below will not be initiated, and your computer will remain up.

- During this test, your UPS protected computer will go down. Therefore, before you commence, make sure that:
- the UPS device is running and is supplying power to the UPS dependent node to be used in the test,
- the shutdown of the UPS dependent node to be tested does not impact on current IT operations,
- no critical processes are running on the UPS dependent node to be tested,
- the physical location of your UPS (complete with AC line power cabling) enables you to re-establish "regular" AC line power within a few seconds.

Proceed as follows:

- 1 Read the instructions below. Be sure you understand the entire procedure before you continue with step 2.
- 2 Pull the AC power plug connecting the UPS to its AC power receptacle.

WARNING:

Do not pull the AC power plug connecting the UPS protected node computer to the UPS.

- 3 Look out for UPS related messages, warnings and status displays on the monitor of your UPS dependent node computer. For instance, when you pull the AC power plug of the UPS, the traffic light on your monitor turns red after a predefined period (peak delay; see *Chapter 9*). At the same time, an alarm message tells you where the alarm has occurred, and the UPS icon turns red.

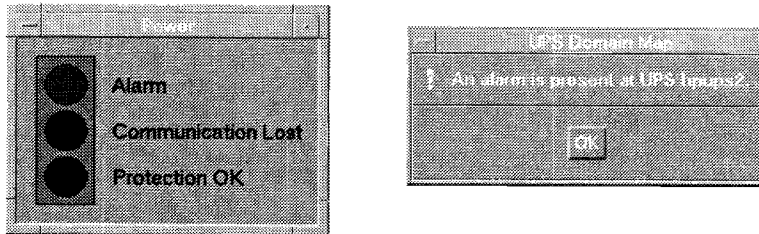

Figure 6-12 Red Traffic Light plus Node Alarm Message

- 4 Provided that you retained the default alarm handling settings, the OnBattery alarm condition will begin to shut down your computer by using the following script after an action delay time of 60 seconds:

```
/etc/shutdown -h -y 0
```

NOTE:

If you decide to discontinue this test, you have 60 seconds (or whatever action delay time is currently defined for the OnBattery alarm) to reconnect the UPS to its AC power receptacle.

- 5 As soon as the OnBattery alarm action is initiated, the following information message window is displayed.

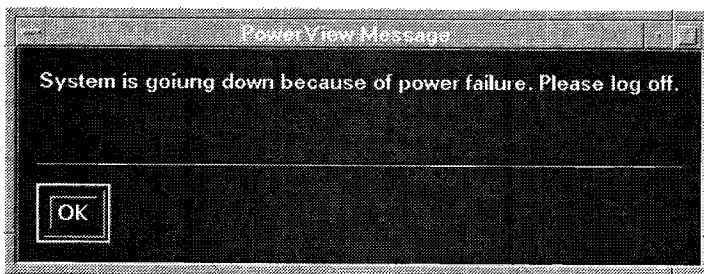

Figure 6-13 Shutdown Message

- 6 The default action duration is 120 seconds. This implies that the UPS will cease to supply battery buffered AC power to your computer two minutes after the action delay time.
- 7 When the computer has shut down, replace the AC power plug connecting the UPS to its AC power receptacle. Then restart your computer as usual.

Results

Results

This chapter provided you with your first hands-on experience in the use of HP UPS Manager II. You now know:

- how to add a UPS to your UPS Domain Map,
 - how to assign nodes to a UPS,
 - what happens in the event of a power failure.
-

Next Steps

- 1 Read *Chapter 7* to familiarize yourself with the HP UPS Manager II user interface.
- 2 Configure each additional UPS (if any) as described in *Chapter 9*.
- 3 Assign each additional HP UPS Manager II UPS protected node (if any) to its associated UPS as described in *Chapter 10*.
- 4 To ensure a graceful shutdown in the event of a power alarm condition, define the logical dependencies (if any) of each HP UPS Manager II managed node. A description of this procedure is provided in *Chapter 10*.
- 5 Define global preferences (time intervals) as described in *Chapter 8*.
- 6 Define alarm actions for all of your HP UPS Manager II managed nodes as described in *Chapter 11*.

The HP UPS Manager II User Interface

The HP UPS Manager II User Interface

This chapter discusses the following:

- Using the HP UPS Manager II Management Station
- The HP UPS Manager II user interface on the Management Station
- The HP UPS Manager II user interface on the HP UPS Manager II managed node computers

Using the HP UPS Manager II Management Station

To start the HP UPS Manager II Management Station, enter the following command:

```
/usr/pvllite/bin/pvlmap
```

This command displays the UPS Domain Map.

NOTE:

You will see an “amber” traffic light during the HP UPS Manager II startup phase.

The HP UPS Manager II User Interface on the Management Station

On the Management Station, the HP UPS Manager II user interface consists of the following elements:

- the UPS Domain Map
- the UPS Segment Map
- the File Server Map
- the HP UPS Manager II pulldown menus
- the panels accessible from the HP UPS Manager II pulldown menus
- warning messages on alarm

The UPS Domain Map

A sample UPS Domain Map (containing icons for four UPSs) is shown below.

The HP UPS Manager II User Interface
The HP UPS Manager II User Interface on the Management Station

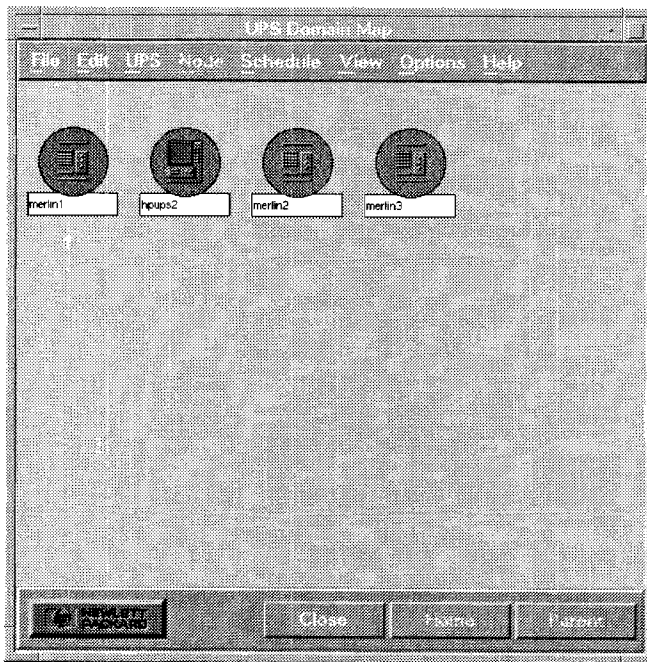

Figure 7-1 **Sample UPS Domain Map**

The UPS Segment Map

To see which UPS protected nodes are currently attached to a given UPS device, simply click on the icon of that UPS in the UPS Domain Map.

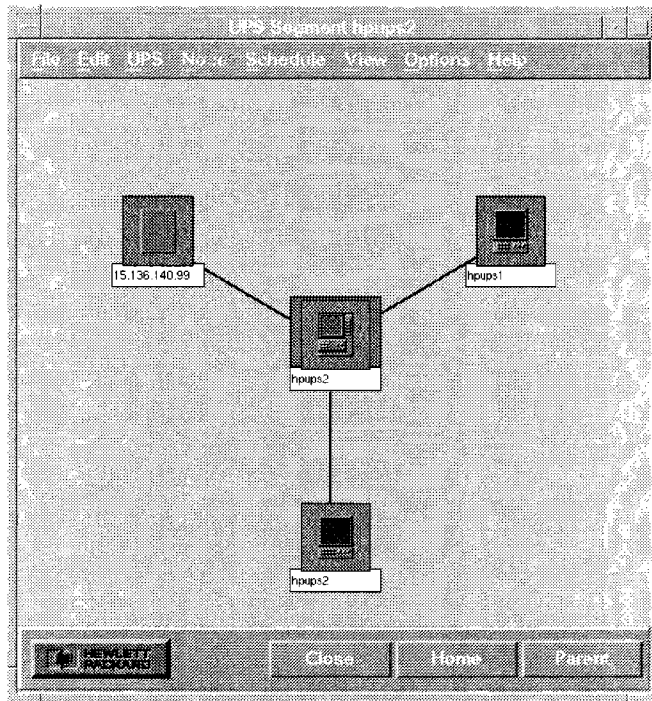

Figure 7-2 **Sample UPS Segment Map**

NOTE:

The procedure for assigning UPS protected nodes to a given UPS device is described in detail in *Chapter 10*.

The File Server Map

To display the HP UPS Manager II File Server Map, double-click on one of the HP UPS Manager II managed node icons in the HP UPS Manager II UPS Segment Map. (A sample UPS Segment Map is provided above.)

A File Server Map will be displayed only if the icon is associated with a computer for which a logical dependency is defined. The method of defining logical client/server dependencies in HP UPS Manager II is described in *Chapter 10*.

The HP UPS Manager II User Interface
The HP UPS Manager II User Interface on the Management Station

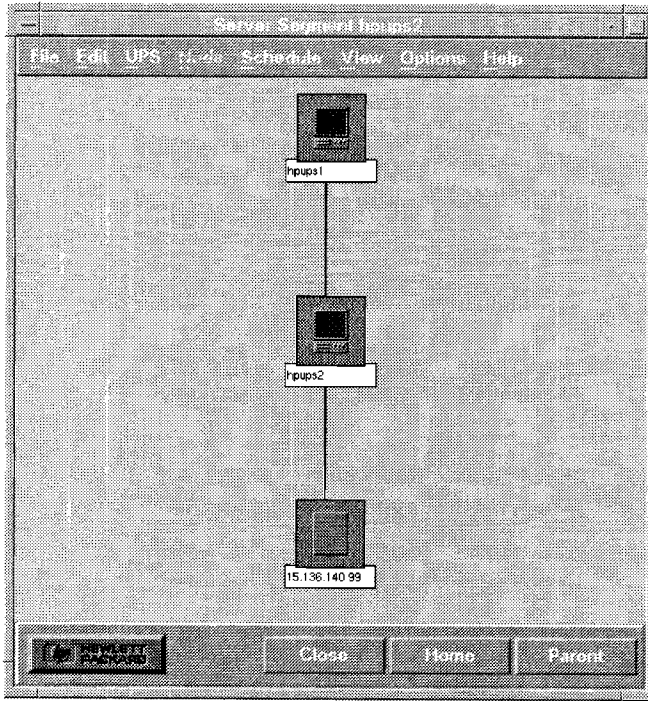

Figure 7-3

Sample File Server Map

Generic Map Buttons

The following buttons are located near the bottom of HP UPS Manager II maps:

- Close** Closes the current map.
- Home** Displays the UPS Domain Map.
- Parent** Moves up one level in the map hierarchy.

The HP UPS Manager II Pulldown Menus

The entire HP UPS Manager II functionality is accessible via pulldown menus. To display one of these pulldown menu, simply click on the associated menu item. The following figure shows the UPS menu.

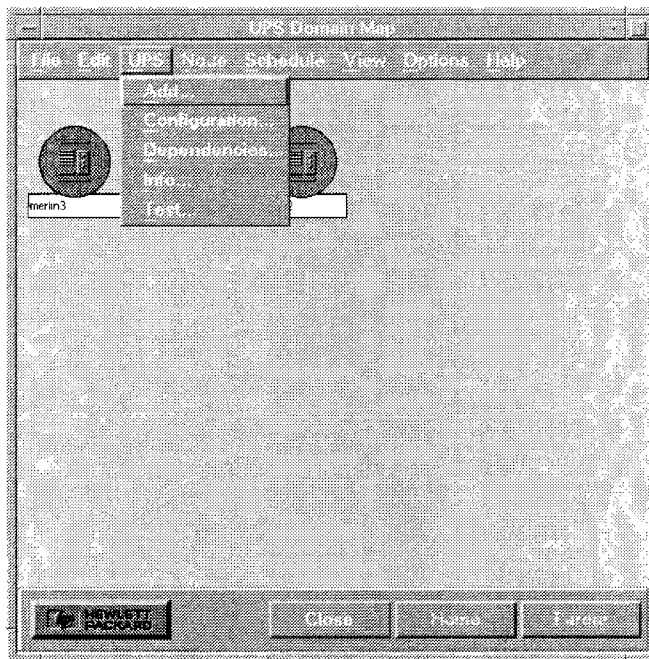

Figure 7-4 Sample HP UPS Manager II Pulldown Menu

Please note that these pulldown menus are **context sensitive**. This means, for instance:

- that you can access the UPS Dependencies panel only after you have selected an icon associated with a given UPS from the UPS Segment Map.
- that you can access the Node Dependencies panel only after you have selected an icon associated with a given computer (such as a file server) which is already defined as a UPS protected node.

The individual HP UPS Manager II pulldown menus are discussed below.

File

From the File menu, you can access the following functions:

- Open Map** This function enables you to open the map for the item associated with an icon highlighted in the current map. It has the same effect as double-clicking on the icon. For instance, you

The HP UPS Manager II User Interface on the Management Station

can use **Open Map** to display the UPS Segment Map associated with a given UPS icon included in the UPS Domain Map.

- Close Map** This function is used to close a map. When you use this function to close a UPS Segment Map, you are prompted for confirmation.
- Exit** Exits HP UPS Manager II.

Edit

From the Edit menu, you can access the following functions:

- Cut** Cuts an icon, deleting its dependencies. Optionally, you can use **Paste** to add this icon to a different map location.
- Copy** Copies an icon without deleting its dependencies. Optionally, you can use **Paste** to add this icon to a different map location.
- Paste** Copies an icon to a new map location. The copied icon becomes dependent on the icon to which you add it.
- Delete** Deletes an icon and its dependencies.

UPS

From the UPS menu, you can access the following functions:

- Add** Enables you to add a UPS to the current UPS Domain Map.
- Configuration** Enables you to specify whether and how power-related alarms will shut down the UPS in response to specific alarm conditions and what delay applies in each case.
- Dependencies** Enables you to assign a node to the current UPS.
- Info** This menu item is used to access the UPS Info panel which enables you to monitor the current state of your UPS device.
- Test** This menu item is used to access the UPS Test panel which enables you to test your UPS device.

Node

From the Node menu, you can access the following functions:

- Configuration** This function displays the Node Configuration panel which enables you to specify whether and how power-related alarms will

The HP UPS Manager II User Interface on the Management Station

shut down in response to specific alarm conditions and what delay applies in each case.

Dependencies This menu item is used to define logical dependencies between HP UPS Manager II managed nodes. Such logical dependencies can be used to govern the sequence in which individual nodes will shut down. For example, a client needs to be shut down before its server can shut down.

Note that this menu item is active only if at least one UPS protected node has been assigned to a given UPS and that the icon associated with that UPS protected node is currently highlighted.

Schedule

From the Schedule menu, you can access the following functions:

Add/Modify

Event

Enables you to specify UPS off and UPS on times for power scheduling.

Modify Action

Enables you to define action, action delay and action duration for power down events.

View

From the View menu, you can access the following functions:

External Graph

Enables you to specify the name of an external graphing program plus associated arguments. Start by highlighting a UPS icon. Then specify a graphing program name (e.g. xnmgraph). For the argument, specify the MIB number of the parameter you want to graph (such as 1.3.6.1.2.1.33.1.2.7 for battery temperature). Refer to *Appendix A* for a complete list of supported MIB conditions.

Browse MIB

Enables you to browse the HP UPS Manager II MIB for a given hostname, community and object ID. Refer to *Appendix A* for a complete list of supported MIB conditions.

Options

From the Options menu, you can access the following functions:

Global Preferences

This menu item is used to define global preferences such as polling intervals.

SNMP Configuration

Enables you to select a different port for each node connected to an SNMP interface module. For use with HP PowerManagement UPS devices (not for HP PowerTrust UPS devices!).

UPS Interface Configuration

Enables you to configure an SNMP interface module for use with HP PowerManagement UPS devices (not for HP PowerTrust UPS devices!).

Help

Enables you to access the HP UPS Manager II Online Help System.

Generic Buttons

The configuration panels include the following generic buttons:

Managed

Defines the current node as a managed node which will be monitored and controlled by its HP UPS Manager II Management Station.

Monitored

Defines the current node as a monitored node which will be monitored (but not actively controlled) by its HP UPS Manager II Management Station or Monitoring Station.

The HP UPS Manager II User Interface on HP UPS Manager II Managed Node Computers

On the HP UPS Manager II managed node computers, a window resembling traffic lights can be displayed.

In the event of a power failure, an alarm message (see "HP UPS Manager II Warning Messages" below) can be displayed on each HP UPS Manager II managed node.

HP UPS Manager II Traffic Lights

On each HP UPS Manager II UPS protected node computer, perform the first-time steps described in "Displaying the HP UPS Manager II Traffic Lights Window" below to display the HP UPS Manager II traffic lights window. In any subsequent session, this window will automatically start with HP VUE.

Displaying the HP UPS Manager II Traffic Lights Window

Complete the following steps to display the HP UPS Manager II traffic lights window on an HP UPS Manager II managed node computer:

- 1 Log in as **root** on the HP UPS Manager II managed node computer.
- 2 Enter the following command to change to the HP UPS Manager II client directory:

```
cd /usr/pvclient
```

- 3 Enter the following command to display the HP UPS Manager II traffic lights window:

```
pvclient
```

- 4 Verify that the following window is displayed:

The HP UPS Manager II User Interface on HP UPS Manager II Managed Node Computers

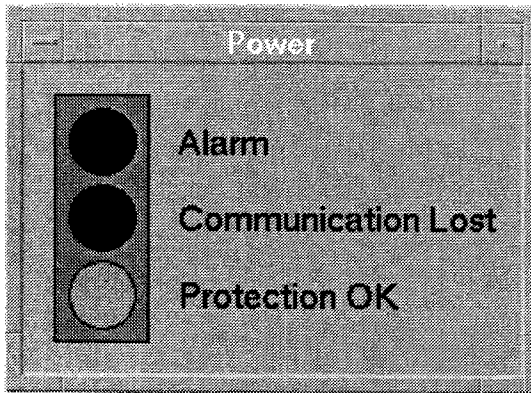

Figure 7-5

Traffic Lights

This window informs the user of the current status of the HP UPS Manager II managed node computer. On HP UPS Manager II UPS protected node computers, the following color definitions apply:

Color	Description
Green	HP UPS backup is active. OK.
Amber	No connection to server.
Red	AC line power alarm.

Alternatively, you can include the pvclient executable name in each user's .profile to ensure that the HP UPS Manager II traffic lights window is displayed following system startup.

Including the Traffic Lights in the HP VUE GUI Bar

Optionally, you can use the vviewmrc script provided in the following directory to place the following icon into the HP VUE GUI menu bar of each HP UPS Manager II UPS protected node computer:

```
/usr/pvclient
```

General guidance is provided in the vviewmrc script itself. A detailed description of the icon integration method is provided in the *HP VUE User's Guide* and in the "Front Panel Help" accessible from the Help subpanel.

The HP UPS Manager II User Interface

The HP UPS Manager II User Interface on HP UPS Manager II Managed Node Computers

For reference, you can use the `vuewmrc.example` file provided in the `/usr/pvclient` directory.

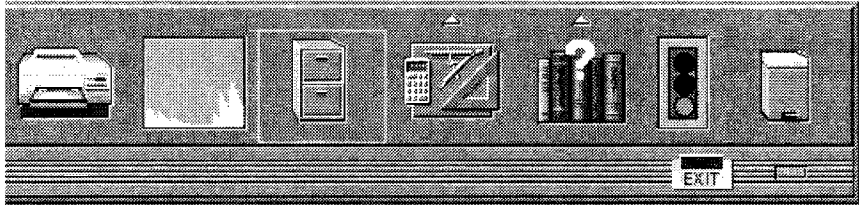

Figure 7-6 **Traffic Lights in HP VUE GUI Bar**

Removing the HP UPS Manager II Traffic Lights Window

If a given HP UPS Manager II managed node is no longer UPS protected (i.e. if a node is deleted from the UPS Protected Nodes panel and from the Logical Dependencies panel), the HP UPS Manager II traffic lights on that node computer's monitor will permanently be set to amber.

To avoid confusion, it is a good idea to delete the HP UPS Manager II traffic lights window (and/or its associated icon) from the HP VUE GUI menu bar of that HP UPS Manager II managed node computer so it will no longer be displayed.

To remove the HP UPS Manager II traffic lights window from a given HP UPS Manager II managed node computer's monitor, simply close the HP UPS Manager II traffic lights window on that monitor. Once the computer is re-started, the traffic lights will no longer be displayed.

NOTE: If the HP UPS Manager II traffic lights window is started by the "pvclient" script specified in the user's `.profile`, you need to delete the `pvclient` script name from the user's `.profile` file.

The HP UPS Manager II User Interface on HP UPS Manager II Managed Node Computers

To remove the HP UPS Manager II traffic lights icon from the HP VUE GUI menu bar, simply delete the lines associated with that icon from the viewmrc file. (See "Including the Traffic Lights in the HP VUE GUI Bar" above for details.)

HP UPS Manager II Warning Messages

In the event of an AC power failure or power outage which exceeds the peak delay (see *Chapter 9*) defined for a given UPS device, a warning message is sent to each HP UPS Manager II UPS protected computer.

The method for enabling or disabling and for changing the wording of such warning messages is discussed in *Chapter 11*.

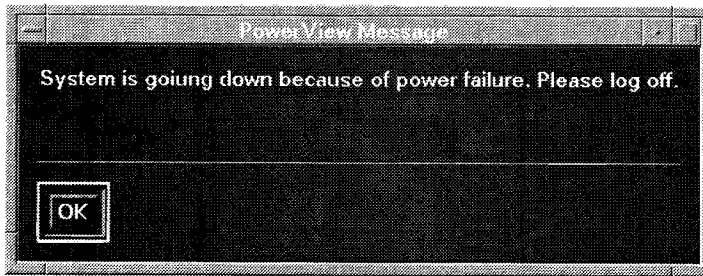

Figure 7-7

Sample Alarm Message and Log Off Prompt

The HP UPS Manager II User Interface

**The HP UPS Manager II User Interface on HP UPS Manager II Managed
Node Computers**

Global Preferences

Global Preferences

The Global Preferences panel accessible from the Options menu enables you to define global operational settings for the HP UPS Manager II environment.

NOTE:

All of the operations governed by Global Preferences take place at HP UPS Manager II startup time and are automatically repeated as per timing intervals specified in the Global Preferences panel.

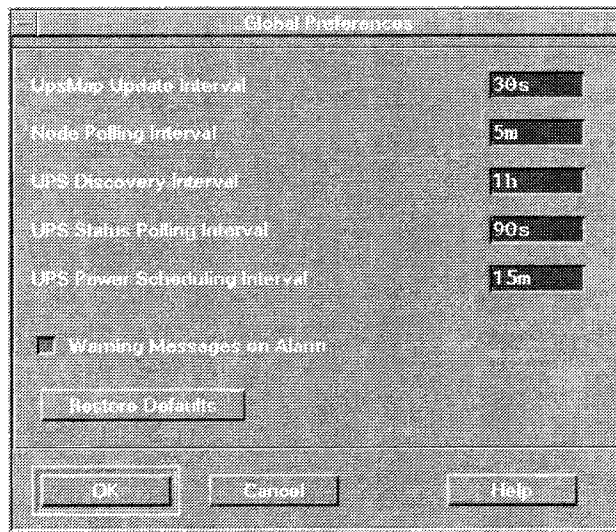

Figure 8-1

Global Preferences

Setting Time Intervals

In the “Interval” fields, you can specify the following units of time:

Unit	Description
s	second
m	minute
h	hour
d	day

The default, minimum and maximum time intervals for global preferences are specified below.

UPS Map Update Interval

The time interval for updating the HP UPS Manager II maps in compliance with HP UPS Manager II database updates. It is a good idea to keep this interval short in order to ensure that any critical events (such as “server lost”) are discovered and acted upon as fast as possible. On the other hand, be aware that a shorter UPS map update interval implies a greater network load.

Default:	30 seconds
Minimum:	20 seconds
Maximum:	5 minutes

Node Polling Interval HP UPS Manager II

The time interval for checking whether the HP UPS Manager II Agent runs on each HP UPS Manager II managed node computer. It is a good idea to keep this value low in order to ensure that any failures in the “UPS device - UPS protected node” allocation structure are detected at the earliest possible stage.

Default:	5 minutes
Minimum:	30 seconds
Maximum:	1 hour

Global Preferences
Setting Time Intervals

UPS Discovery Interval

The time interval for searching for new UPS devices. Since it is unlikely that UPS devices are added or replaced at frequent intervals, there is usually no need to move towards the minimum interval.

Default: 1 hour
Minimum: 1 minute
Maximum: 7 days

UPS Status Polling Interval

The time interval for checking the alarm status of a UPS device. If you specify a short interval, any UPS device related problems are discovered very briefly after they occur. However, this will increase the network load. If you specify an interval nearer the maximum, UPS device failures may remain undetected for a fairly long period of time, thus impairing the power protection you intend to safeguard.

Default: 90 seconds
Minimum: 20 seconds
Maximum: 5 minutes

UPS Power Scheduling Interval

The time interval for checking for event scheduling interrupts.

Default: 15 minutes
Minimum: 1 minute
Maximum: 30 minutes

Warning Messages on Alarm

When this check box is depressed, warning messages are issued to the HP UPS Manager II Management Station in the event of a power-related alarm.

Global Preferences

Restore Defaults

Restore Defaults

This button enables you to restore the defaults for this panel.

Configuring UPS Devices

Adding an HP PowerTrust UPS Device

For HP PowerTrust UPS devices, you need to install the proxy agent as described in *Chapter 4*. Then pull down the UPS menu and select Add. When you have added the UPS to your UPS Domain map, you can configure the UPS as described on the following page.

**Connecting and Configuring
HP PowerManagement UPS Devices**

Connecting and Configuring HP PowerManagement UPS Devices

When you have completed the installation instructions in *Chapter 2* (for HP-UX rev. 9) or *Chapter 3* (for HP-UX rev. 10), you are ready to connect and configure your HP PowerManagement UPS devices. This procedure includes the following steps:

- Connecting each UPS device to a suitable AC power outlet.
- Connecting each UPS device to the network.
- Connecting each UPS device to its associated SNMP interface module.
- Connecting the individual HP UPS Manager II managed nodes to their associated UPS device(s).

Adding an HP PowerManagement UPS Device

Provided that your UPS device is connected and configured (see *Chapter 5* for details), you can add this UPS manually to the UPS Domain submap by pulling down the UPS menu and selecting Add to display the following box:

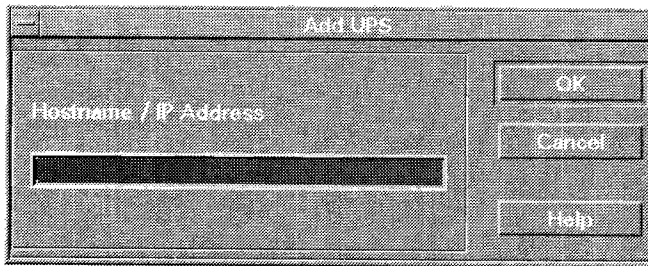

Figure 9-1

Add UPS

Use this box to specify the hostname or IP address of the SNMP agent associated with the SNMP interface module of the UPS device to be configured.

NOTE:

HP UPS Manager II supports the use of a single UPS device on each HP UPS Manager II UPS protected node. Consequently, you cannot attach multiple UPS devices to the same HP UPS Manager II UPS protected node computer. However, you can link multiple HP UPS Manager II UPS protected node computers to the same UPS.

After you have specified the hostname or IP address of the UPS, a new UPS object is created and added to the HP UPS Manager II map. HP UPS Manager II then automatically starts to poll the UPS device as per UPS Discovery Interval (see *Chapter 8* for details).

NOTE:

Be sure to select the appropriate configuration (described below) for each newly added UPS.

Configuring a UPS Device

- 1 Select the appropriate UPS icon in the UPS Segment Map.
- 2 Pull down the UPS menu and select Configuration. The system displays the following panel:

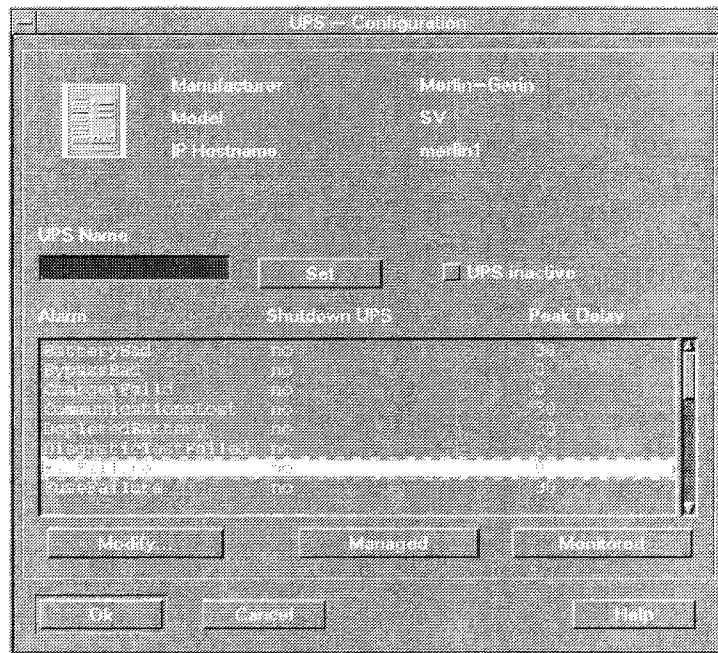

Figure 9-2 UPS Configuration

NOTE: A complete list of alarm conditions is provided in *Appendix A*.

Panel Item	Description
Set	Enables you to specify a name for the UPS.
UPS inactive	Enables you to disable the current UPS so that you can exchange this UPS without triggering any alarms.
Alarm	Specifies the alarm conditions.

- Shutdown UPS** In this column, a yes/no flag enables you to specify whether or not the UPS is to be shut down if any of the alarm conditions occur.
- Peak Delay** Enables you to specify the number of seconds for which HP UPS Manager II will tolerate a given alarm condition before initiating appropriate action. This delay is used to ignore short-term conditions (such as power transients).

Modifying Alarm Conditions

To modify any of the Alarm, Shutdown UPS and Peak Delay lines, click on that line and then click on the Modify... button to display a dialog box such as the following:

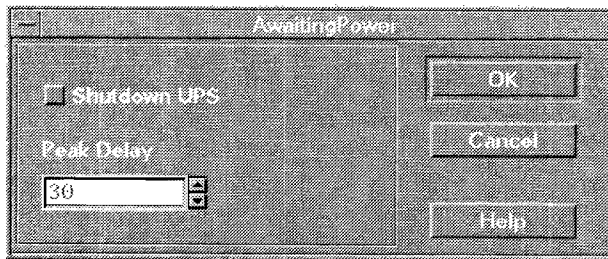

Figure 9-3 Modifying Alarm Condition Response

SNMP Port Configuration

NOTE:

This section applies to HP PowerManagement UPS devices only.

The SNMP port is the port between the HP UPS Manager II Management Station and the UPS as well as between the HP UPS Manager II Management Station and each HP UPS Manager II UPS protected node attached to the UPS.

By default, HP UPS Manager II uses the standard SNMP/UDP port 161 for SNMP communication with UPS agents and HP UPS Manager II agents.

Selecting a Different SNMP Port

For HP PowerManagement UPS devices only: You can specify another port for each node in the HP UPS Manager II maps. This is done by highlighting a node, pulling down the Options menu and selecting **SNMP Configuration** to display the following panel:

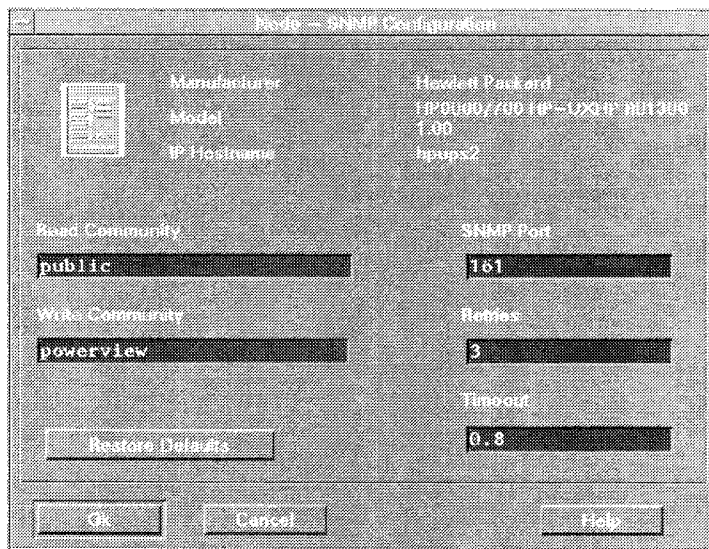

Figure 9-4 SNMP Port Configuration

NOTE:

The access permissions for the Read and Write communities are defined on a group level. For security reasons, it is a good idea to replace `public` by a more restrictive setting. The default `public` setting also needs to be changed if your UPS vendor uses different community names.

Next Steps

Once your UPS device is configured as described above, you are ready to assign HP UPS Manager II UPS protected nodes to it as described in *Chapter 10*.

Configuring UPS Devices

Next Steps

**Setting Up UPS Protected Nodes and
Defining Logical Dependencies**

In order to set up HP UPS Manager II UPS protected nodes, you need to perform the following steps:

- The HP UPS Manager II client filesets need to be installed on each HP UPS Manager II managed node computer you want to define as a UPS protected node. This procedure is described in *Chapter 2* (for HP-UX rev. 9) and *Chapter 3* (for HP-UX rev. 10).
- Each node (computer, router, or any other active network component supported by HP OpenView) for which you want to ensure HP UPS Manager II UPS protection needs to be allocated to a specific UPS device. This procedure is described in "Assigning an HP UPS Manager II Managed Node to its Associated UPS Device" below.
- Define any logical dependencies for each HP UPS Manager II UPS protected node. This procedure is described in "Defining the Logical Dependencies of each HP UPS Manager II Managed Node" below.

NOTE:

In the event of an AC line power failure, Routers need to remain "up" until all active network components connected to them are shut down. HP UPS Manager II Therefore, select No PowerView Control for your UPS protected routers. However, be sure to allocate your router(s) to the appropriate UPS device(s) and to define the logical dependencies for each router.

Assigning an HP UPS Manager II Managed Node to its Associated UPS Device

The following instructions apply to computers running HP-UX. For non-HP-UX platforms, use the *HP UPS Solution Pac CD-ROM* supplied with HP PowerManagement UPS devices (not with HP PowerTrust UPS devices!) to install each non-HP-UX computer.

Once you have physically connected the AC power cable of an HP UPS Manager II managed node to a given UPS device, you need to tell HP UPS Manager II which UPS device the HP UPS Manager II managed node is connected to.

NOTE:

The following instructions assume that you have already configured the UPS device. Please note that any computer (server or client) or other active network-manageable component linked to a given UPS needs to be defined as an HP UPS Manager II UPS protected node for its associated UPS.

To determine which HP UPS Manager II managed nodes are currently connected to a specific UPS, open the “Physical View” of the UPS by double-clicking on the icon associated with that UPS in the corresponding HP UPS Manager II map. If no HP UPS Manager II managed node is yet defined as a UPS protected node, this HP UPS Manager II map will contain only the UPS object.

Proceed as follows to allocate an HP UPS Manager II UPS protected node to a given UPS:

- 1 Double-click on the appropriate UPS icon in the UPS Domain Map. The system returns the UPS Segment Map for the associated UPS device.
- 2 Select the UPS icon from the UPS Segment Map.
- 3 Pull down the UPS menu and select Dependencies. The system displays the following or a similar panel.

Setting Up UPS Protected Nodes and Defining Logical Dependencies
Assigning an HP UPS Manager II Managed Node to its Associated UPS Device

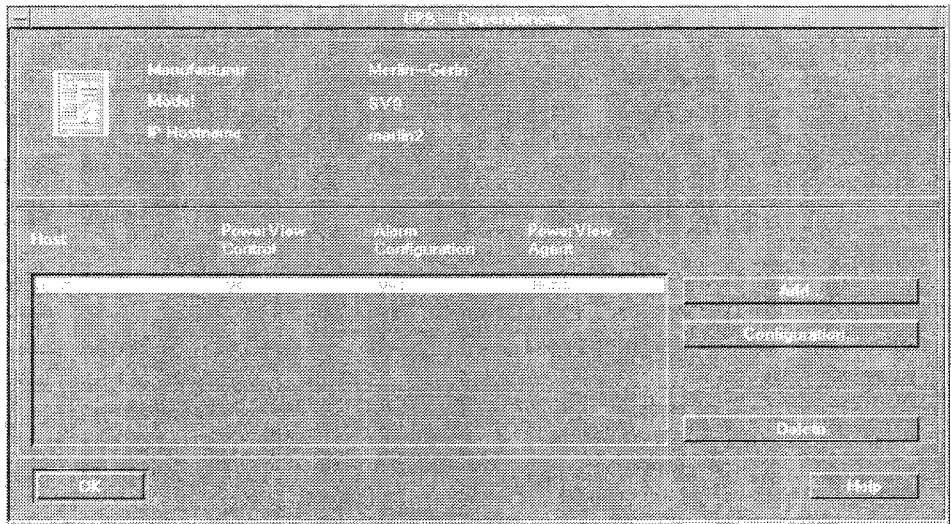

Figure 10-1 UPS Dependencies

NOTE: The agent settings in this panel are either running or not running or trap client. Please note that trap client is used for all non-HP-UX platforms (such as PCs running Windows NT).

- 4 Click on the Add ... button in the UPS Dependencies panel.

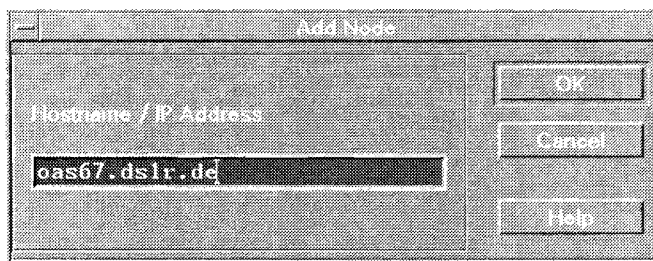

Figure 10-2 Add Node

- 5 Enter the hostname or the IP address of the HP UPS Manager II managed node you want to assign to the current UPS device.

Setting Up UPS Protected Nodes and Defining Logical Dependencies
Assigning an HP UPS Manager II Managed Node to its Associated UPS Device

- 6** Click on OK.
- 7** Repeat this procedure for each additional HP UPS Manager II managed node you want to set up as an HP UPS Manager II UPS protected node on the same UPS device.
- 8** If you are using multiple UPS devices, repeat this procedure for each UPS device.

Next Steps

Next Steps

Once you have assigned your UPS protected nodes to their associated UPS device(s), you can define specific alarm actions for each of these node as described in *Chapter 11*.

However, it may be a good idea to define the logical dependencies for each of your HP UPS Manager II managed nodes before you define any alarm actions.

Defining the Logical Dependencies of each HP UPS Manager II Managed Node

In order to ensure a graceful shutdown of your HP UPS Manager II managed nodes, you need to tell HP UPS Manager II which dependencies exist between these nodes. These dependencies can be used to control the sequence in which nodes are shut down.

For example, Clients 1, 2, 3, and 4 shown in *Appendix D* depend on Server 1. This implies that Server 1 can be shut down only after its four clients have shut down.

The procedure for defining this type of logical dependency is outlined below.

- 1 From the UPS Domain Map, double-click on the icon of a UPS device. The system returns the associated UPS Segment Map.
- 2 From the UPS Segment Map, select the node icon of the UPS protected node (such as a file server or a router) to which you want to assign HP UPS Manager II managed nodes as logically dependent nodes.
- 3 Pull down the Node menu and select Dependencies to display the Logical Dependencies panel for the HP UPS Manager II managed node you selected in step 2 above. Then click on Add.

Setting Up UPS Protected Nodes and Defining Logical Dependencies
Defining the Logical Dependencies of each HP UPS Manager II Managed Node

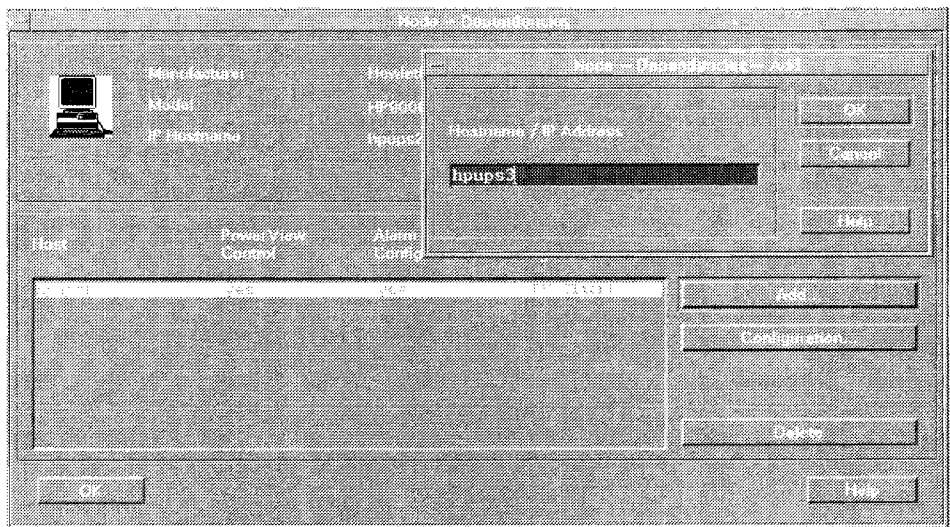

Figure 10-3 Logical Dependencies Panel

- 4 Enter the hostname or the IP address of the (dependent) HP UPS Manager II managed node you want to assign to the HP UPS Manager II managed node specified in the header of the Logical Dependencies panel.
- 5 Click on OK.
- 6 Repeat this procedure for any additional HP UPS Manager II managed nodes that need to be allocated to the HP UPS Manager II managed node specified in the header of the Logical Dependencies panel.

Upon successful completion of this procedure, the system displays the UPS Segment Map. As a result of this procedure, the HP UPS Manager II managed node to which you assigned other HP UPS Manager II managed nodes now has its own File Server Map. You can display this map by double-clicking on the icon of that UPS protected node in the UPS Segment Map.

The following figure shows an example of the resulting File Server Map for an HP UPS Manager II managed file server to which a single HP UPS Manager II managed node has been allocated as a client.

Setting Up UPS Protected Nodes and Defining Logical Dependencies
Defining the Logical Dependencies of each HP UPS Manager II Managed Node

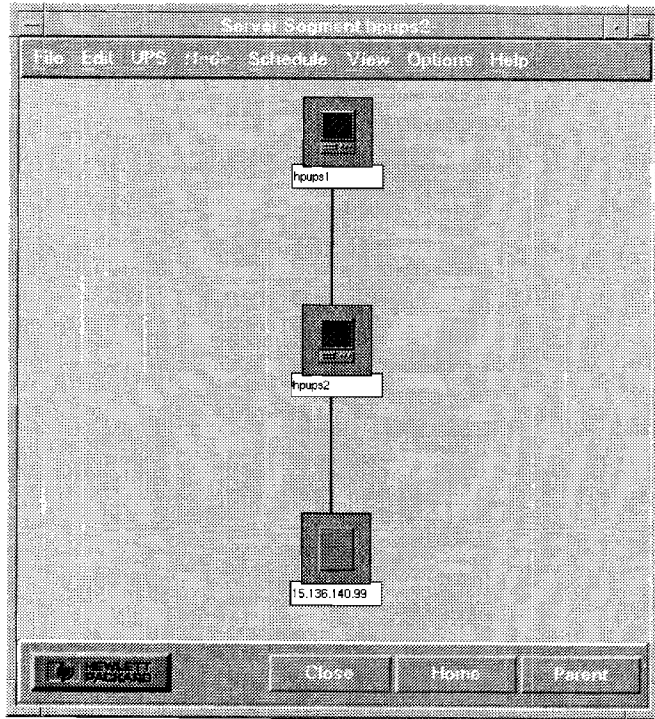

Figure 10-4

File Server Submap

NOTE:

Please note that the “depth” of logical dependencies in HP UPS Manager II is unlimited. In other words, any HP UPS Manager II managed nodes which logically depends on another HP UPS Manager II managed node can have its own dependent nodes.

Next Steps

Next Steps

Unless you have already done so, you can now define the alarm action for each HP UPS Manager II managed node as described in *Chapter 11*.

**Defining Alarm Actions for HP UPS
Manager II Managed Nodes**

Defining Alarm Actions for HP UPS Manager II Managed Nodes

HP UPS Manager II You can define specific alarm actions for HP UPS Manager II managed nodes running HP-UX. The procedure is described below.

NOTE:

The HP UPS Manager II Management Station and Monitoring Station are also handled as an HP UPS Manager II managed node. Therefore, the following instructions also apply to the HP UPS Manager II Management Station and/or Monitoring Station.

Also, please note that non-HP-UX platforms are triggered by client software provided on the HP UPS Solution Pac CD-ROM supplied with HP PowerManagement UPS devices (not HP PowerTrust UPS devices!).

Selecting an Alarm Condition and Defining Alarm Actions

Proceed as follows to define the appropriate action parameters and settings for a given alarm condition in HP UPS Manager II:

- 1** Double-click on the appropriate UPS icon from the UPS Domain Map. The system returns the UPS Segment Map for the associated UPS device.
- 2** Select the UPS icon from the UPS Segment Map.
- 3** Pull down the Node menu and select Configuration.
- 4** Click on Defaults for (system type) and select the appropriate computer series (HP9000/700 or HP9000/800).
- 5** Click on Managed or on Monitor to select the defaults for managed or monitored nodes, respectively.

Defining Alarm Actions for HP UPS Manager II Managed Nodes Selecting an Alarm Condition and Defining Alarm Actions

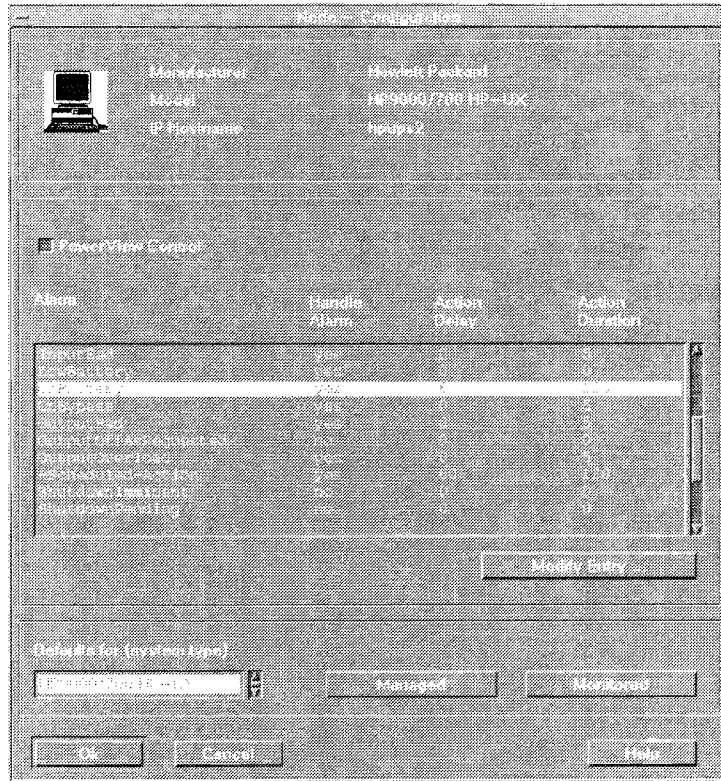

Figure 11-1 Default Alarm Actions

- 6 To modify the settings for a given alarm condition, select the line associated with that alarm condition (e.g. OnBattery) and click on Modify Entry to display the following or a similar panel:

Defining Alarm Actions for HP UPS Manager II Managed Nodes Selecting an Alarm Condition and Defining Alarm Actions

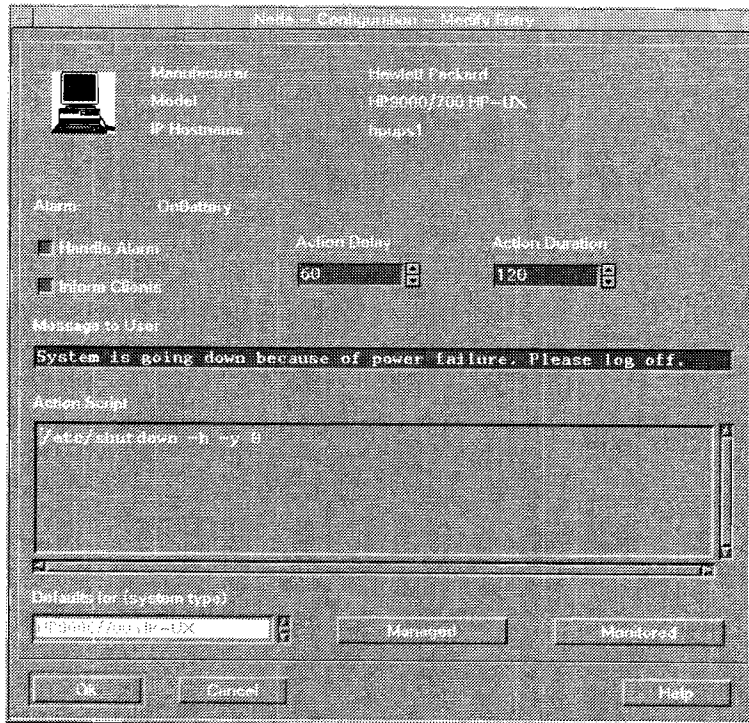

Figure 11-2 UPS Alarm Actions - Modify

- 7 Select the appropriate settings for the Handle Alarm and Inform Clients check boxes.
- 8 Specify the appropriate values for Action Delay and Action Duration.
- 9 Click OK to confirm your alarm action settings.

NOTE: Figure 11-2 above shows a typical example of an alarm action complete with action delay and action duration setting. Illustrated examples are provided in *Appendix E*.

HP UPS Manager II Alarm Action Settings and Parameters

The following definitions apply to the HP UPS Manager II alarm action settings and parameters in the UPS Alarm Actions - Modify panel.

Alarm

This field specifies the name of the alarm condition according to the UPS-MIB (see *RFC 1628, Chapter 4.6 “The Alarm Group”, upsWellknownAlarms*). See *Appendix A* for a description of each alarm condition.

Please note that the <server name>-Down and -Scheduled-Action alarms are special HP UPS Manager II features.

Handle Alarm

This is a yes/no toggle. If this button is “depressed” (i.e. set to “yes”), HP UPS Manager II invokes the defined actions on the HP UPS Manager II managed node if this alarm occurs. If this button is raised (i.e. set to “no”), no actions are executed.

Inform Clients

This is a yes/no toggle. If this button is “depressed” (i.e. set to “yes”), in the event of a power-related alarm condition, HP UPS Manager II sends the appropriate signal to each HP UPS Manager II managed node dependent on the HP UPS Manager II managed node specified in the header of the UPS Alarm Actions panel. If this button is raised (i.e. set to “no”), no actions are executed.

Action Delay

This field enables you to define a time delay (in seconds) for the specified action. This time delay needs to be dimensioned such that appropriate measures can be taken before the delayed action commences.

For example, the user of a particular HP UPS Manager II managed node computer should be informed of a pending shutdown so that appropriate steps (saving files, logging out etc.) can be completed.

Defining Alarm Actions for HP UPS Manager II Managed Nodes

HP UPS Manager II Alarm Action Settings and Parameters

To enable HP UPS Manager II to perform a cascaded shutdown of your cluster(s), the action delays in a client/server cluster need to be defined such that all clients of a cluster can disconnect from their associated server before the server shuts down. Illustrated examples are provided in *Appendix E*.

Action Duration

The actual duration (runtime in seconds) of the action. This is an empirical value based on actual time measurements of shutdown processes. For example, if you know from experience that a given client takes 45 seconds to shut down, the action duration for its shutdown command should be 45 seconds plus an appropriate safety margin.

Message to User

This field enables you to enter a message which will be displayed on the HP UPS Manager II managed node computer specified on the current “UPS Alarm Actions - Modify” panel for the current alarm condition. Please note that this message will only be displayed on the HP UPS Manager II managed node computer if “Handle Alarm” (see above) is set to “yes”.

NOTE:

For customization, any prompts and messages sent to the user at each HP UPS Manager II managed node computer can be modified as required. The maximum length of this text line is 256 characters.

Action Script

This field enables you to specify action scripts (e.g. shell scripts such as /etc/shutdown) which are executed on the connected HP UPS Manager II managed nodes in the event of an alarm condition.

NOTE:

For customization, each action script can be edited as required. Its maximum length is 1024 characters.

By pressing Use Default, you can re-establish the HP UPS Manager II default settings for alarm actions.

Illustrated examples of the use of these control features are provided in *Appendix E*.

Defining Alarm Actions for HP UPS Manager II Managed Nodes
HP UPS Manager II Alarm Action Settings and Parameters

Power Scheduling

Power Scheduling

The scheduling capabilities of HP UPS Manager II enable you to power down (and up) all devices (including the HP UPS Manager II ManagementHP UPS Manager II Station) attached to a given HP UPS Manager II UPS. Your HP UPS Manager II UPS device will automatically “wake up” at the scheduled “UPS on” time.

When defining power schedules in HP UPS Manager II, be sure to account for the logical dependencies (see *Chapter 10*) of your cluster(s) and the associated shutdown and startup sequences.

Defining a Power Schedule

Proceed as follows to define a power schedule for a HP UPS Manager II managed cluster:

- 1 In HP UPS Manager II, mark the appropriate UPS in the UPS Segment Map.
- 2 Pull down the Schedule menu and select Add/Modify Event. The system displays the Power Scheduling panel.

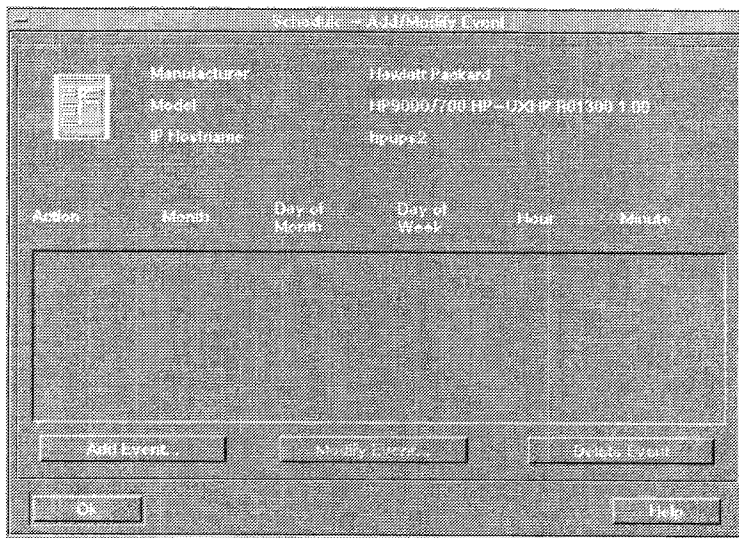

Figure 12-1 Power Scheduling Panel

- 3 Click on **Add Event** to define a new power schedule.

NOTE: Use the “up” and “down” selection arrows to select the appropriate setting in each spin box. You cannot edit the fields displayed in the UPS Schedule panel.

Please note that the minute settings can be changed in 15 minute increments.

- 4 Enter the date and time for UPS off.
- 5 Enter the date and time for UPS on.

Power Scheduling
Defining a Power Schedule

The following figure shows a sample schedule.

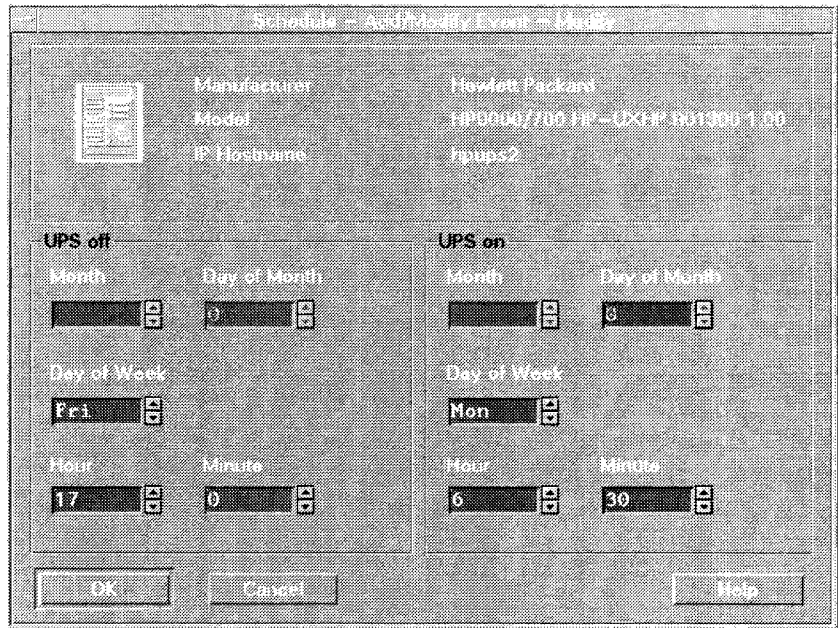

Figure 12-2 Sample UPS Schedule

- 6 Press OK to confirm. The previous sample schedule yields the following entries in the Power Scheduling panel:

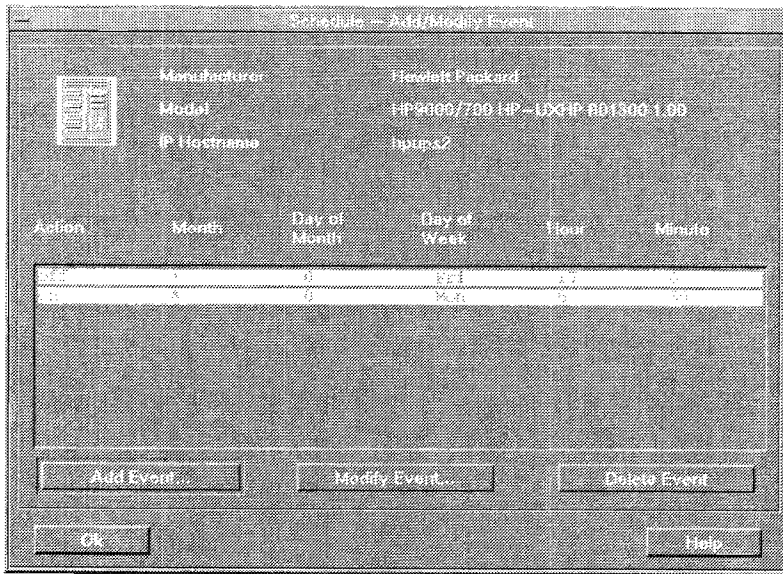

Figure 12-3 Sample Entries in Power Scheduling Panel

These entries imply that the UPS will power down on Friday at 5:00 pm and will restart on Monday at 7:00 am.

NOTE: HP UPS Manager II uses 24 hour notation. This means, for instance, that 5:00 pm is expressed as 17:00.

If the UPS on event is scheduled for an earlier date and time than the UPS off event, the UPS on event will be handled the next day if scheduled daily, the next week if scheduled weekly, or the same month of the following year if scheduled monthly.

Defining Additional Power Schedules

To define additional power schedules, simply repeat the procedure outlined in "Defining a Power Schedule". The mechanism for handling partly or wholly overlapping power schedules is discussed below.

Overlapping Schedules

The following section discusses the combined effect of two overlapping power schedules.

NOTE:

Please note that any UPS off overrides any overlapping UPS on. This effect is illustrated in Figure 12-4.

Schedule 1

- The UPS is scheduled to power down every night (seven days a week) at 9:00 pm.
- UPS supported power supply is resumed at 6:00 am every morning.

Schedule 2

- The UPS is scheduled to power down every Friday at 6:00 pm.
- UPS supported power supply is resumed every Monday at 3:00 am.

Combined Effect of Schedules 1 and 2

- The UPS commences its working week by powering up on Monday morning at 6:00 am.
- The UPS powers down at 9:00 pm on Monday night.
- This procedure is repeated on Tuesday, Wednesday and Thursday.
- On Friday, the UPS powers down at 6:00 pm and remains down until Monday morning.

This mechanism is illustrated in the following diagram. Please note that hatched bars indicate scheduled downtime.

Power Scheduling
Defining Additional Power Schedules

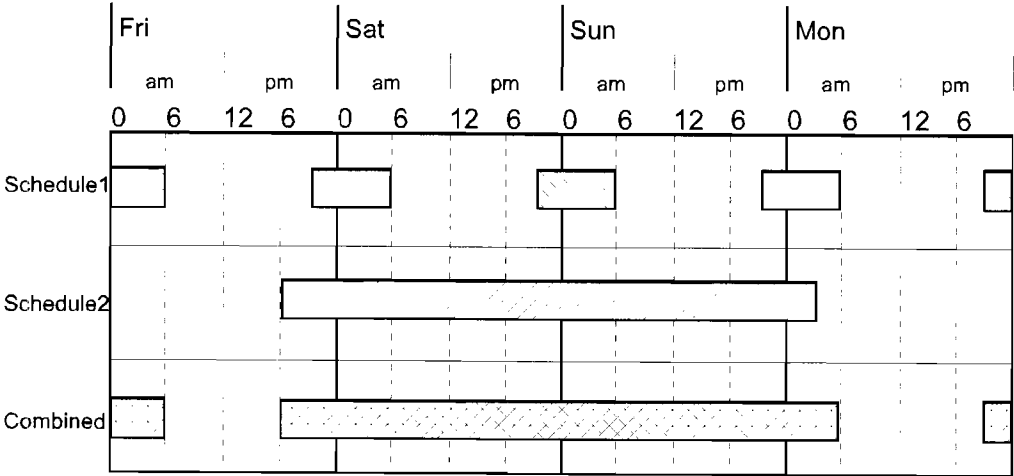

Figure 12-4 Multiple (Overlapping) Power Schedules

Schedule Action

This function enables you to define action, action delay and action duration for power down events. When you have selected a computer icon from the UPS Segment Map, pull down the Schedule menu and select Modify Action to display the following or a similar panel:

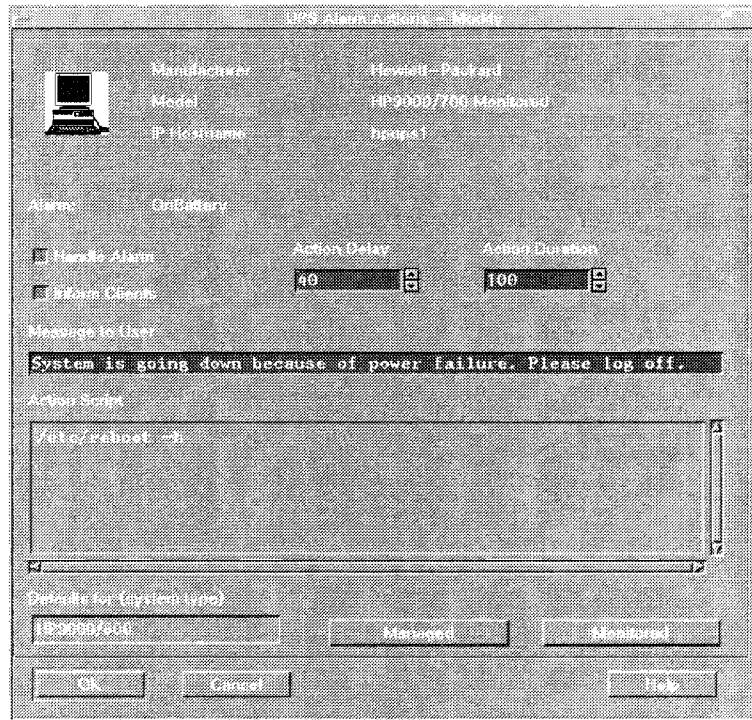

Figure 12-5 Schedule Action

NOTE: The fields of this panel are discussed in *Chapter 11*.

Monitoring the Status of UPS Devices

Monitoring the Status of UPS Devices

The HP UPS Manager II UpsMon process constantly monitors the status of UPS devices. Following initial UPS discovery, this process polls at regular intervals (see *Chapter 8* for details) for specific MIB values to check for any alarm conditions. It then sets the status of the UPS device in the HP UPS Manager II database. UpsMap reads the HP UPS Manager II database at regular intervals to check for the status of UPS devices and reflects any status changes encountered (alarms) by color highlighting the appropriate icon on the HP UPS Manager II or IP submaps.

Additionally, you are able to monitor the values of several additional UPS specific MIB values by opening the UPS Info dialog (shown in the following figure) for a selected UPS.

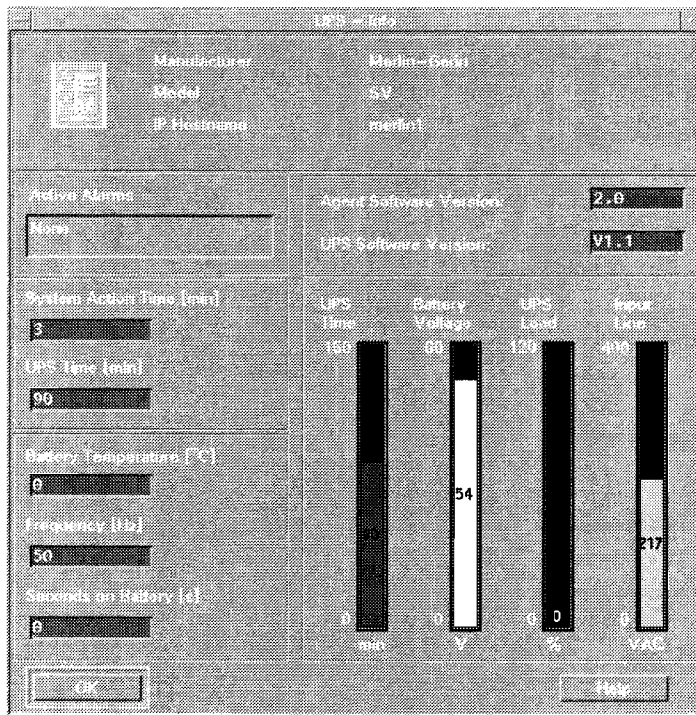

Figure 13-1

UPS Info

UPS Operating Parameters

Active Alarms

All values except System Action Time are related to UPS-MIB entries and are updated by polling the MIB of the specified UPS in a defined time interval. (See *Chapter 8* for details.)

Seconds on Battery

This field tells you for how many seconds the UPS device has supplied battery buffered power during the current UPS duty cycle. Note that this value will be reset to 0 by a shutdown and subsequent restart of the UPS device.

Frequency

This field indicates the AC power line cycles (e.g. 50 or 60 Hz during normal operation).

UPS Temperature

This field indicated the current temperature inside of the UPS device (provided that this feature is supported by your UPS device).

NOTE:

Not all UPS devices provide temperature readings. See your UPS device documentation for specifications.

UPS Time

This value is an estimate of the remaining AC backup power time of the UPS device. Be aware of the fact that the actual UPS backup time depends on battery load (which can change dramatically if additional current is drawn by activated disk drives or other devices) and the battery condition. Because this is a time dependent value, HP UPS Manager II checks in defined intervals for this value and compares it with the computed "System Action Time".

Monitoring the Status of UPS Devices

UPS Operating Parameters

System Action Time

System Action Time describes the maximum shutdown time of the HP UPS Manager II managed nodes connected to this UPS in case of an alarm. This value is calculated by HP UPS Manager II using the information provided by the user in the alarm action dialogs. Both logical and power dependent actions for each node are checked for the longest time definitions for any of the alarms. If the value for System Action Time exceeds the value for UPS Time, a message such as the following is sent to the HP UPS Manager II user

```
System Shutdown Time exceeds UPS backup time. System will not  
shut down correctly in case of any UPS alarm!
```

NOTE:

The System Action Time accounts for the time required by the “last” HP UPS Manager II managed node in a given logical dependency structure (see *Chapter 10*) to shut down.

UPS Time Bar

The UPS Time bar indicates the time value displayed in the UPS Time field. This value is an estimate of the remaining AC backup power time of the UPS device. Be aware of the fact that the actual UPS backup time depends on battery load (which can change dramatically if additional current is drawn by activated disk drives or other devices) and the battery condition. Because this is a time dependent value, HP UPS Manager II checks in defined intervals for this value and compares it with the computed “System Action Time”.

Battery Voltage Bar

The Battery Voltage bar indicates the DV voltage (in volts) currently supplied by the UPS device.

UPS Load Bar

The UPS Load bar indicates the current UPS load. This value reflects the actual vs. design load in percent.

CAUTION:

Any UPS Load value in excess of 100% indicates an overload condition.

Input Line Bar

The Input Line bar indicates the AC line voltage (in volts) supplied to the UPS device.

Monitoring the Status of UPS Devices
UPS Operating Parameters

Testing a UPS Device

Testing a UPS Device

The standard UPS-MIB supports different UPS tests. The tests implemented in HP UPS Manager II are described below. To initiate a UPS test, you need to call up the UPS Test panel from the UPS menu.

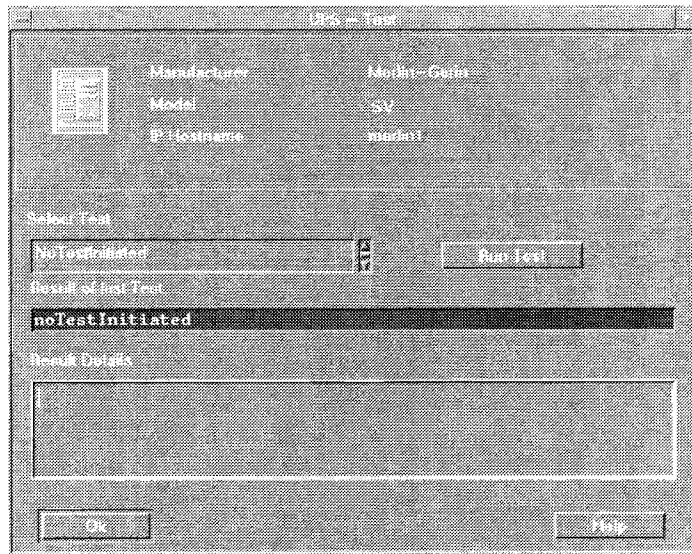

Figure 14-1

UPS Test

In this dialog box, you can select a test from the selection box and invoke it by pressing the Run Test button. Information about the last passed test will be shown in the edit boxes Result of Last Test and Result Details which correspond to UPS-MIB entries.

The underlying UpsMap process also checks the current state of the HP UPS Manager II Agents in the network by polling the PowerView database at regular intervals. If the HP UPS Manager II Agent of an HP UPS Manager II managed node is lost, its associated node symbol will be highlighted in color.

Supported UPS Tests

Table 1

UPS Test	Description
AbortTestInProgress	This test aborts a UPS test currently in progress.
GeneralSystemTest	This test subjects the UPS to a vendor-defined general test.
QuickBatteryTest	This test subjects the UPS battery to a brief general performance test.
DeepBatteryCalibration	This test assesses the performance characteristics of the UPS battery for calibration purposes.

NOTE: Some UPS device models may not support all four tests. Please refer to the documentation shipped with your UPS hardware for details.

Testing a UPS Device
Supported UPS Tests

A

**IETF RFC 1628 UPS-MIB II
Conditions**

Supported IETF RFC 1628 UPS-MIB II Conditions

HP UPS Manager II supports the IETF RFC 1628 UPS-MIB II conditions specified in the MIB tree below. Please note the following:

- HP PowerManagement UPS devices support all of the conditions specified below
- HP PowerTrust UPS devices support the conditions marked by an asterisk (*)

Interpreting the MIB Tree

The prefix for the following MIB tree is 1.3.6. (which stands for iso.org.dod.). For example, the MIB number for upsAlarmPresent is:

```
1.3.6.1.2.1.33.1.6.1
```

The MIB Tree

```
1.3.6. = iso.org.dod.
1: internet
  2: mgmt
    1: mib-2
      33: upsMIB
        1: upsObjects
          1: upsIdent
            1: upsIdentManufacturer *
            2: upsIdentModel *
            3: upsIdentUPSSoftwareVersion *
            4: upsIdentAgentSoftwareVersion *
            5: upsIdentName
            6: upsIdentAttachedDevices *
          2: upsBattery
            1: upsBatteryStatus *
            2: upsSecondsOnBattery *
            3: upsEstimatedMinutesRemaining *
            4: upsEstimatedChargeRemaining *
            5: upsBatteryVoltage *
            6: upsBatterymandatory *
            7: upsBatteryTemperature *
          3: upsInput
            1: upsInputLineBad *
            2: upsInputNumLines *
            3: upsInputTable
              1: upsInputEntry
                1: upsInputLineIndex *
                2: upsInputFrequency *
                3: upsInputVoltage *
```

IETF RFC 1628 UPS-MIB II Conditions
Supported IETF RFC 1628 UPS-MIB II Conditions

```

4: upsInputmandatory
5: upsInputTruePower
4: upsOutput
  1: upsOutputSource *
  2: upsOutputFrequency *
  3: upsOutputNumLines *
  4: upsOutputTable
    1: upsOutputEntry
      1: upsOutputLineIndex *
      2: upsOutputVoltage *
      3: upsOutputmandatory
      4: upsOutputPower
      5: upsOutputPercentLoad
5: upsBypass
  1: upsBypassFrequency
  2: upsBypassNumLines
  3: upsBypassTable
    1: upsBypassEntry
      1: upsBypassLineIndex
      2: upsBypassVoltage
      3: upsBypassmandatory
      4: upsBypassPower
6: upsAlarm
  1: upsAlarmsPresent *
  2: upsAlarmTable
    1: upsAlarmEntry
      1: upsAlarmId *
      2: upsAlarmDescr *
      3: upsAlarmTime *
  3: upsWellKnownAlarms
    1: upsAlarmBatteryBad
    2: upsAlarmOnBattery *
    3: upsAlarmLowBattery *
    4: upsAlarmDepletedBattery
    5: upsAlarmTempBad
    6: upsAlarmInputBad
    7: upsAlarmOutputBad
    8: upsAlarmOutputOverload
    9: upsAlarmOnBypass
    10: upsAlarmBypassBad
    11: upsAlarmOutputOffAsRequested
    12: upsAlarmUpsOffAsRequested *
    13: upsAlarmChargerFailed
    14: upsAlarmUpsOutputOff
    15: upsAlarmUpsSystemOff
    16: upsAlarmFanFailure
    17: upsAlarmFuseFailure
    18: upsAlarmGeneralFault *
    19: upsAlarmDiagnosticTestFailed
    20: upsAlarmCommunicationsLost *
    21: upsAlarmAwaitingPower
```

IETF RFC 1628 UPS-MIB II Conditions

Supported IETF RFC 1628 UPS-MIB II Conditions

- 22: upsAlarmShutdownPending
- 23: upsAlarmShutdownImminent
- 24: upsAlarmTestInProgress
- 7: upsTest
 - 1: upsTestId *
 - 2: upsTestSpinLock
 - 3: upsTestResultsSummary
 - 4: upsTestResultsDetail
 - 5: upsTestStartTime
 - 6: upsTestElapsedTime
 - 7: upsWellKnownTests
 - 1: upsTestNoTestsInitiated
 - 2: upsTestAbortTestInProgress
 - 3: upsTestGeneralSystemsTest
 - 4: upsTestQuickBatteryTest
 - 5: upsTestDeepBatteryCalibration
- 8: upsControl
 - 1: upsShutdownType *
 - 2: upsShutdownAfterDelay *
 - 3: upsStartupAfterDelay *
 - 4: upsRebootWithDuration *
 - 5: upsAutoRestart *
- 9: upsConfig
 - 1: upsConfigInputVoltage
 - 2: upsConfigInputFreq
 - 3: upsConfigOutputVoltage
 - 4: upsConfigOutputFreq
 - 5: upsConfigOutputVA
 - 6: upsConfigOutputPower
 - 7: upsConfigLowBattTime
 - 8: upsConfigAudibleStatus
 - 9: upsConfigLowVoltageTransferPoint
 - 10: upsConfigHighVoltageTransferPoint
- 2: upsTraps
 - 4: upsTrapAlarmEntryRemoved
 - 3: upsTrapAlarmEntryAdded
 - 1: upsTrapOnBattery
 - 2: upsTrapTestCompleted

Supported Alarm Conditions

This section provides a more detailed description of the alarm conditions supported by HP UPS Manager II. In addition to the IETF RFC 1628 UPS-MIB II compliant alarm conditions listed in the previous section, HP UPS Manager III provides two additional alarm conditions for enhanced functionality. Please note the following:

- HP PowerManagement UPS devices support all of the conditions specified below
- HP PowerTrust UPS devices support the conditions marked by an asterisk (*)

NOTE:

The defaults specified in this appendix apply to **managed nodes only**. For **monitored nodes**, the default status for all alarm conditions is **inactive**. This implies that, by default, no message is issued to users and no script is executed.

IETF RFC 1628 UPS-MIB II Standard Alarm Conditions

The alarm conditions specified below are defined in the IETF RFC 1628 UPS-MIB II standard.

All defaults specified below are specifically defined by Hewlett-Packard for HP UPS Manager II.

NOTE:

Please note that HP PowerManagement UPS devices support the full range of alarm conditions specified below. HP PowerTrust UPS devices support a subset of this specification.

BatteryBad

One or more batteries are due for replacement.

Criterion	Default
Peak Delay	30 seconds
Shutdown	No
Handle Alarm	Yes
Inform Clients	No
Action Delay	0 seconds
Action Duration	5 seconds
Message	Battery of UPS is bad. Please contact your system administrator.
Command	None

OnBattery *

This alarm is issued if the AC line power fails.

Criterion	Default
Peak Delay	30 seconds

IETF RFC 1628 UPS-MIB II Conditions
IETF RFC 1628 UPS-MIB II Standard Alarm Conditions

Shutdown	Yes
Handle Alarm	Yes
Inform Clients	Yes
Action Delay	60 seconds
Action Duration	120 seconds
Message	System is going down because of power failure. Please log off.
Command	/etc/shutdown -h -y 0

LowBattery *

The residual battery backup time is less than the configured time, e.g. due to excessive UPS load.

Criterion	Default
Peak Delay	30 seconds
Shutdown	No
Handle Alarm	Yes
Inform Clients	No
Action Delay	0 seconds
Action Duration	5 seconds
Message	None
Command	None

DepletedBattery

On account of battery charge depletion, the UPS is unable to supply AC power for the required period of time.

Criterion	Default
Peak Delay	30 seconds
Shutdown	No

IETF RFC 1628 UPS-MIB II Standard Alarm Conditions

Handle Alarm No
Inform Clients No
Action Delay 0 seconds
Action Duration 0 seconds
Message None
Command None

TempBattery

The temperature in the UPS device is above the limit threshold.

Criterion **Default**
Peak Delay 120 seconds
Shutdown No
Handle Alarm Yes
Inform Clients No
Action Delay 0 seconds
Action Duration 5 seconds
Message Temperature problem of UPS. Please contact your system administrator.
Command None

InputBad

An AC power input parameter for the UPS is out of range.

Criterion **Default**
Peak Delay 30 seconds
Shutdown No
Handle Alarm Yes
Inform Clients No

Action Delay 0 seconds

Action Duration 5 seconds

Message Input power bad. Please contact your system administrator.

Command None

OutputBad

An AC power output parameter of the UPS is out of range.

Criterion Default

Peak Delay 30 seconds

Shutdown No

Handle Alarm Yes

Inform Clients No

Action Delay 0 seconds

Action Duration 5 seconds

Message Output power bad. Please contact your system administrator.

Command None

OutputOverload

The AC power output load is too high.

Criterion Default

Peak Delay 0 seconds

Shutdown No

Handle Alarm Yes

Inform Clients No

Action Delay 0 seconds

Action Duration 5 seconds

Message UPS is overloaded. Please disconnect one of the powered devices.

Command None

OnBypass

The UPS device is currently supplying AC line power via its bypass.

Criterion **Default**

Peak Delay 0 seconds

Shutdown No

Handle Alarm Yes

Inform Clients No

Action Delay 0 seconds

Action Duration 5 seconds

Message UPS is on bypass. Please contact your system administrator.

Command None

BypassBad

The UPS bypass is currently down.

Criterion **Default**

Peak Delay 0 seconds

Shutdown No

Handle Alarm Yes

Inform Clients No

Action Delay 0 seconds

Action Duration 5 seconds

Message Bypass of UPS is bad. Please contact your system administrator.

Command None

OutputOffAsRequested

The UPS has initiated a shutdown as requested.

Criterion **Default**

Peak Delay 0 seconds

Shutdown No

Handle Alarm No

Inform Clients No

Action Delay 0 seconds

Action Duration 0 seconds

Message None

Command None

UpsOffAsRequested

The entire UPS is off, as requested.

Criterion **Default**

Peak Delay 0 seconds

Shutdown No

Handle Alarm No

Inform Clients No

Action Delay 0 seconds

Action Duration 0 seconds

Message None

Command None

ChargerFailed

Problem in the battery charger subsystem.

Criterion	Default
Peak Delay	0 seconds
Shutdown	No
Handle Alarm	Yes
Inform Clients	No
Action Delay	0 seconds
Action Duration	0 seconds
Message	Cannot reload battery. Please contact your system administrator.
Command	None

UpsOutputOff

The UPS AC power output is off.

Criterion	Default
Peak Delay	0 seconds
Shutdown	No
Handle Alarm	No
Inform Clients	No
Action Delay	0 seconds
Action Duration	0 seconds
Message	None
Command	None

UpsSystemOff

The UPS is off.

IETF RFC 1628 UPS-MIB II Conditions
IETF RFC 1628 UPS-MIB II Standard Alarm Conditions

Criterion	Default
Peak Delay	0 seconds
Shutdown	No
Handle Alarm	No
Inform Clients	No
Action Delay	0 seconds
Action Duration	0 seconds
Message	None
Command	None

FanFailure

Fault in one or more fans.

Criterion	Default
Peak Delay	0 seconds
Shutdown	No
Handle Alarm	No
Inform Clients	No
Action Delay	0 seconds
Action Duration	0 seconds
Message	None
Command	None

FuseFailure

One or more fuses tripped.

Criterion	Default
Peak Delay	30 seconds
Shutdown	No

IETF RFC 1628 UPS-MIB II Standard Alarm Conditions

Handle Alarm	Yes
Inform Clients	No
Action Delay	0 seconds
Action Duration	5 seconds
Message	Fuse failure at UPS. Please contact your system administrator.
Command	None

GeneralFault *

A general fault has occurred.

Criterion	Default
Peak Delay	30 seconds
Shutdown	Yes
Handle Alarm	Yes
Inform Clients	Yes
Action Delay	60 seconds
Action Duration	120 seconds
Message	General fault on UPS. Please log off.
Command	/etc/shutdown -h -y 0

DiagnosticTestFailed

The most recent test run has revealed a fault.

Criterion	Default
Peak Delay	0 seconds
Shutdown	No
Handle Alarm	Yes
Inform Clients	No

Action Delay	0 seconds
Action Duration	5 seconds
Message	Diagnostic test on UPS failed. Please contact your system administrator.
Command	None

CommunicationLost *

The UPS has lost the connection to its SNMP interface (for HP PowerManagement UPS devices) or to its proxy agent (for HP PowerTrust UPS devices).

Criterion	Default
Peak Delay	30 seconds
Shutdown	No
Handle Alarm	Yes
Inform Clients	No
Action Delay	0 seconds
Action Duration	5 seconds
Message	Lost communication with UPS. Please contact your system administrator.
Command	None



AwaitingPower

The outputs of the UPS are off and waiting for input power.

Criterion	Default
Peak Delay	0 seconds
Shutdown	No
Handle Alarm	No
Inform Clients	No
Action Delay	0 seconds

IETF RFC 1628 UPS-MIB II Standard Alarm Conditions

Action Duration 0 seconds

Message None

Command None

ShutdownImminent

A UPS shutdown is imminent.

Criterion **Default**

Peak Delay 0 seconds

Shutdown No

Handle Alarm No

Inform Clients No

Action Delay 0 seconds

Action Duration 0 seconds

Message None

Command None

ShutdownPending

A UPS shutdown is pending.

Criterion **Default**

Peak Delay 0 seconds

Shutdown No

Handle Alarm No

Inform Clients No

Action Delay 0 seconds

Action Duration 0 seconds

Message None

Command None

TestInProgress

UPS self-test in progress.

Criterion	Default
Peak Delay	0 seconds
Shutdown	No
Handle Alarm	No
Inform Clients	No
Action Delay	0 seconds
Action Duration	0 seconds
Message	None
Command	None

Additional HP UPS Manager II Specific Alarm Conditions

The following two alarm conditions were specifically defined for use in distributed client/server environments controlled by HP UPS Manager II.

-Scheduled-Action *

A scheduled shutdown is about to commence.

Criterion	Default
Peak Delay	0 seconds
Shutdown	Yes
Handle Alarm	Yes
Inform Clients	Yes
Action Delay	60 seconds
Action Duration	120 seconds
Message	Scheduled time for shutdown is reached. System is going down in 60 s.
Command	/etc/shutdown -h -y 0

<server name>-Down *

The server <server name> goes down.

Criterion	Default
Peak Delay	0 seconds
Shutdown	Yes
Handle Alarm	Yes
Inform Clients	No
Action Delay	0 seconds

Action Duration 5 seconds

Message Server is going down. Please log off.

Command None

The UPS Alarm Actions panel for the <server name>-Down alarm is shown below. The <server name>-Down alarm condition ensures that all HP UPS Manager II managed nodes which logically depend on a given HP UPS Manager II managed server receive the <server name>-Down alarm message.

See *Appendix E* for illustrated examples of the use and effect of the <server name>-Down alarm condition.

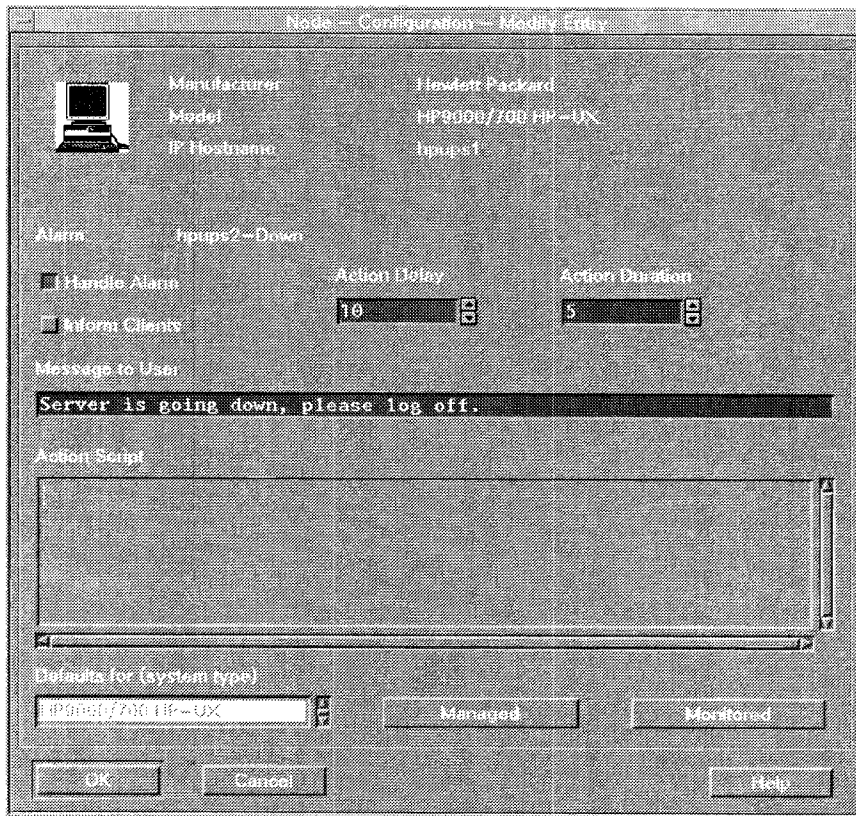

Figure A-1 <server name>-Down

IETF RFC 1628 UPS-MIB II Conditions
Additional HP UPS Manager II Specific Alarm Conditions

B

Event Logging

Event Logging

The HP UPS Manager II database stores all UPS alarm entries, the UPS configuration (UPS Map), and configuration details. All events that cause a modification of a field in the HP UPS Manager II database will be written to a logfile. These logfiles are located in the following directory:

```
/usr/pvllite/log
```

Each entry in the logfile consists of:

- the change date/time
- the information that is used to access this database field
- the actual name of the database field
- the new value of the field

The access information for the field are the keys and indexes of the HP UPS Manager II database, for example:

- IP address of changed node
- index of changed alarm action
- index of schedule entry

The changed field governs which kind of access information is written to the log entry. Both UpsMon and UpsMap generate their own logfiles.

There is no user interface for accessing and modifying these log files. However, access for service engineers is provided through a standard editor.

NOTE:

Log files are “read-only”. Modifications are possible only through service copies.

Generally speaking, a log file has no length limit. However, it may be a good idea to check the file size and to back up the log files before a reasonable size limit is exceeded. The log file may be closed and filed by the system administrator. If a log file was closed, the system starts with a new log file by increasing the log file number.

C

**HP UPS Manager II Database
Maintenance Utilities**

HP UPS Manager II Database Maintenance Utilities

The `/usr/pv-lite/bin` directory contains the following utilities:

- `cleardb`
- `createdb`
- `delnode`
- `readdef`
- `resetdb`
- `rmdb`
- `showdb`

These utilities run in interactive mode. To start one of these utilities, simply enter the applicable utility name and reply to the prompts issued by the system.

Each of these utilities is briefly discussed below.

NOTE:

You need to be root to use these utilities.

List of Utilities



cleardb

When you “delete” items (such as UPS protected nodes) with the aid of the associated HP UPS Manager II panels, these items are merely marked for deletion so that they are no longer active HP UPS Manager II objects.

The cleardb utility physically deletes any items marked for deletion in the database.

createdb

This utility creates an empty HP UPS Manager II database. When setting up a new HP UPS Manager II database, be sure to use the following method:

- 1 Use rmdb (described below) to remove the existing HP UPS Manager II database.
- 2 Use createdb to create your new HP UPS Manager II database.
- 3 Use readdef (described below) to write defaults into the HP UPS Manager II database.

delnode

This utility enables you to mark an HP UPS Manager II managed node and all of its dependencies for deletion.

readdef

This utility writes defaults for alarm configurations, system definitions, etc., into the database. You need to run the readdef utility after you have used createdb to create a new HP UPS Manager II database.

resetdb

This utility resets all HP UPS Manager II managed nodes to status OK and all alarms to inactive.

List of Utilities

rmdb

This utility removes the existing database so that you can run createdb to create a new HP UPS Manager II database.

showdb

This utility enables you to view the contents of the HP UPS Manager II database. A number of parameters facilitates this procedure. To display a list of these parameters, simply enter a string such as **showdb -xyz**.

D

Troubleshooting

Application Problems, Remedies and Workarounds

If you encounter any problems while using HP UPS Manager II, please check the following sections for symptoms and corrective actions. Refer to *Appendix A* for the MIB conditions specified in this appendix.

General Problems

The pvinstall script "hangs"

Correct the display variable setting by entering a command such as:

```
export DISPLAY=<hostname>:0.0
```

No icon appears for a newly added UPS

Check that the serial cable connection (cable type, pinouts, etc) to the UPS device is OK.

If you are using an HP PowerTrust UPS (plus proxy agent), enter the following commands to verify that the upsmond, upsd and upsagt processes are running:

```
ps -ef | grep upsmond  
ps -ef | grep upsd  
ps -ef | grep upsagt
```

Check the communities of the Management Station and of the SNMP interface module or of the proxy agent.

A newly added UPS is not licensed following installation

The icon for a newly added UPS does not turn green. Remember that one license (plus codeword) is supplied with HP UPS Manager II. Therefore, this problem should not occur when you set up your first UPS. This problem can only occur when you set up additional UPS devices. It can be remedied by the following procedure:

- 1 Enter the following command:

```
/usr/pvlight/bin/pvkey
```

- 2 This command returns a list of all UPS related licenses. If the IP address of the newly added UPS is not listed, add a new license. If the IP address is listed, perform the following step.

- 3 Enter the following command to stop the background process:

```
/usr/pvlight/bin/pvlstop
```

4 Enter the following command to start the background process:

```
/usr/pvllite/bin/pvlstart
```

The UPS icon should turn green following the next polling interval.

The UPS symbol does not appear after a new database was created

Run the following command:

```
/usr/pvllite/bin/readsys
```

NOTE: Always use `/usr/pvllite/bin/newdb` to create a new database.

There appears to be no connection to a UPS protected computer

Use View -> Browse MIB to check that the following values are returned for all SNMP interface module COM ports where a UPS is connected:

```
1.3.6.1.2.1.33.1.1.1.0: MERLIN GERIN  
1.3.6.1.2.1.33.1.1.2.0: SX12  
1.3.6.1.2.1.33.1.1.3.0: V1.0  
1.3.6.1.2.1.33.1.1.4.0: 2.0
```

If these values are not returned, check for the following problem causes:

- The RS232 board is missing or damaged
- The RS232 cable connecting the SNMP interface module and the UPS is missing or damaged
- The RS232 cable is connected to another DB9 outlet (COM1, ... COM4) of the SNMP interface module.

SNMP Related Problems

SNMP interface fails to send an alarm to HP UPS Manager II

Force a poll to the UPS through the IP map node. If this measure does not resolve the problem, proceed with the following action.

- 1 Disconnect the UPS from the SNMP interface module and read the MIB values (via View -> Browse MIB). If these values are not OK, you need to configure the SNMP interface module as discussed in *Chapter 5*.
- 2 Connect the UPS and simulate an alarm. If no alarm is sent, replace the SNMP interface module.

SNMP interface cannot boot; bootp fails in UPS configuration

Application Problems, Remedies and Workarounds

Use a VT100 terminal emulator and configure the SNMP interface module directly. Once connected, press the + key twice to start the configuration. Follow the instructions provided in your *SNMP Interface Handbook*.

The SNMP interface module needs to be reset through the network

If you have no direct physical access to the SNMP interface module, you can reset it through the network by entering the following command:

```
/usr/pv-lite/bin/snmpset <ip@> 1.3.6.1.4.1.705.1.12.9.0 integer 1
```

/usr/pv-lite/snmpset <ip@> or hostname <mib-var> does not work but /etc/ping <ip@ or hostname> works

The cause of this problem is an incorrect gateway address. The snmp replies are not sent back by the receiver to the correct sender. Configure the SNMP interface module as discussed in *Chapter 5*.

You need to check SNMP communication

Enter the following to perform a READ check:

```
/usr/pv-lite/bin/snmpget merlin2.bbn.hp.com 1.3.6.1.2.1.33.1.1.1.0  
./snmpget merlin2.bbn.hp.com 1.3.6.1.2.1.33.1.1.2.0
```

You should get the following return values:

```
1.3.6.1.2.1.33.1.1.1.0: Merlin Gerin  
1.3.6.1.2.1.33.1.1.2.0: SX12
```

Enter the following to perform a WRITE check:

```
/snmpget merlin2.bbn.hp.com 1.3.6.1.2.1.33.1.8.3.0  
./snmpset merlin2.bbn.hp.com 1.3.6.1.2.1.33.1.8.3.0 INTEGER 99
```

You should get the following return values:

```
1.3.6.1.2.1.33.1.8.3.0: 0  
1.3.6.1.2.1.33.1.8.3.0: 99
```

The snmpdm HP-UX snmp master agent encounters problems with the "public" community

If the HP UPS Manager III client program does not function correctly on a UPS protected computer (i.e., if you get "Communication Lost" erroneously), you need to change the community values. Enter the following commands:

```
set-community-name: <password other than public>  
get-community-name: <password other than public>
```

Tasks

You need to remove the HP UPS Manager II filesets

Use the HP-UX de-installation scripts (such as rmf).n).

You want to check if HP UPS Manager II runs properly

Generate an alarm by disconnecting the serial cable from the UPS. HP UPS Manager II should return the Communication Lost alarm (1.3.6.1.2.1.33.1.6.20: upsAlarmCommunicationsLost).

Required Processes

If you encounter any problems other than the conditions described above, check that the following required processes are running.

NOTE:

If you are using HP-UX rev. 9, remember that /usr applies instead of /opt!

General Processes

If you encounter any problems other than the conditions described above, check that the following required processes are running.

/usr/pvlight/pvimap

This is the graphical user interface (GUI) process for configuring HP UPS Manager II. It is started by the user.

/usr/pvlight/pvlmon

This is a background process for controlling communication. It is started by the /etc/rc and /sbin/init.d scripts.

/etc/snmpdm

This is the master agent for client communication. It is started by HP-UX.

/etc/mib2agt

This is the MIB-II subagent for snmpdm. It is started by HP-UX.

/usr/pvclient/pviewagt

This client agent runs as a background process. It controls the communication between the Management Station and its clients. It is started by HP UPS Manager II.

/usr/pvclient/pvclient

This process provides the graphical user interface (traffic lights) on the UPS protected computers. It is started by the user.

Proxy Agent Processes

/usr/pvproxy/upsmond

This control script for the proxy agent starts upsd (unless it is already running) and sends an alarm if it cannot start. This process runs permanently in background mode.

/usr/pvproxy/upsd

Daemon for HP PowerTrust UPS communication through a serial interface. It is started by the operating system.

/usr/pvproxy/upsagt

This proxy subagent controls the communication with snmpdm.

Troubleshooting
Required Processes

E

Examples

About This Appendix

This appendix uses two examples to illustrate the typical sequence of messages and actions triggered by an AC power failure.

- The network and dependency structures of both sample clusters are illustrated in easy-to-grasp figures.
- The first example provides detailed instructions for defining the UPS protected nodes of a cluster, the logical dependencies of computers in a cluster, and appropriate alarm actions accounting for these dependencies.
- Timing diagrams plot the sequence of events against time.

Example 1

The first example involves a simple cluster. Its network and dependency structures are shown below.

Network Structure

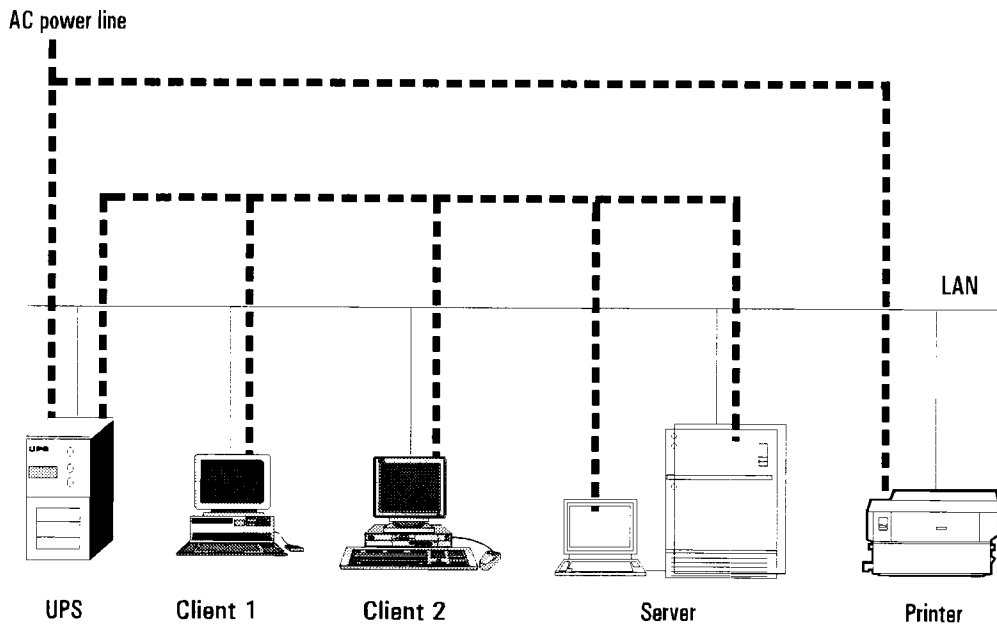

Figure E-1 Sample Network Structure

Examples
Example 1

Dependency Structure

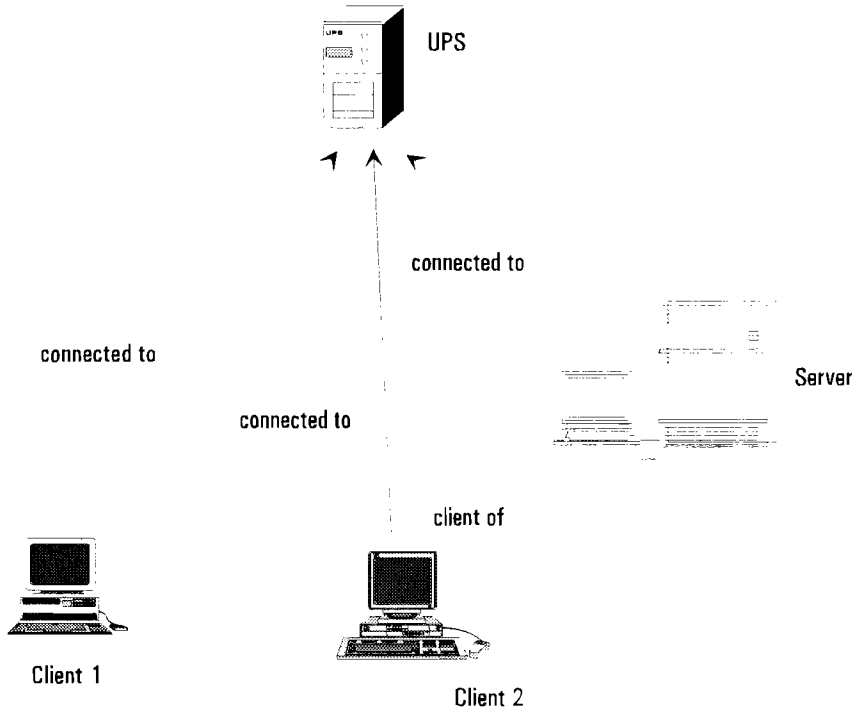

Figure E-2 **Sample Dependency Structure**

Procedure

To provide UPS support for the dependency structure shown in Figure E-2, you need to perform the following steps:

- Define the UPS protected nodes of the cluster.
- Define the logical dependencies of the cluster.
- Define alarm actions for the cluster.

These steps are described in detail below.

Defining UPS Protected Nodes

NOTE: The procedure for setting up UPS protected nodes in HP UPS Manager II is discussed in *Chapter 10*.

Proceed as follows to assign Client 1, Client 2, and Server to the UPS:

- 1 In the UPS Domain Map, double-click on the icon associated with the UPS device to which you want to allocate UPS protected nodes. The system displays the UPS Segment Map of that UPS device.
- 2 In the UPS Segment Map, select the icon associated with the UPS device.
- 3 Pull down the UPS menu and select Dependencies.
- 4 Click on Add
- 5 Enter the hostname or IP address of Client 1.
- 6 Press OK to confirm.
- 7 Repeat the previous two steps for Client 2 and Server.

Defining Alarm Actions

NOTE: Optionally, you can define your alarm actions after you have defined the logical dependencies as outlined below. However, you may find it more convenient to adhere to the sequence of steps illustrated in this example.

The procedure for defining alarm actions is discussed in *Chapter 11*.

- 1 In the selection list displayed in the UPS Protected Nodes panel, mark the entry for Client 1.
- 2 Click on Configuration to display the following or a similar panel.

Examples
Example 1

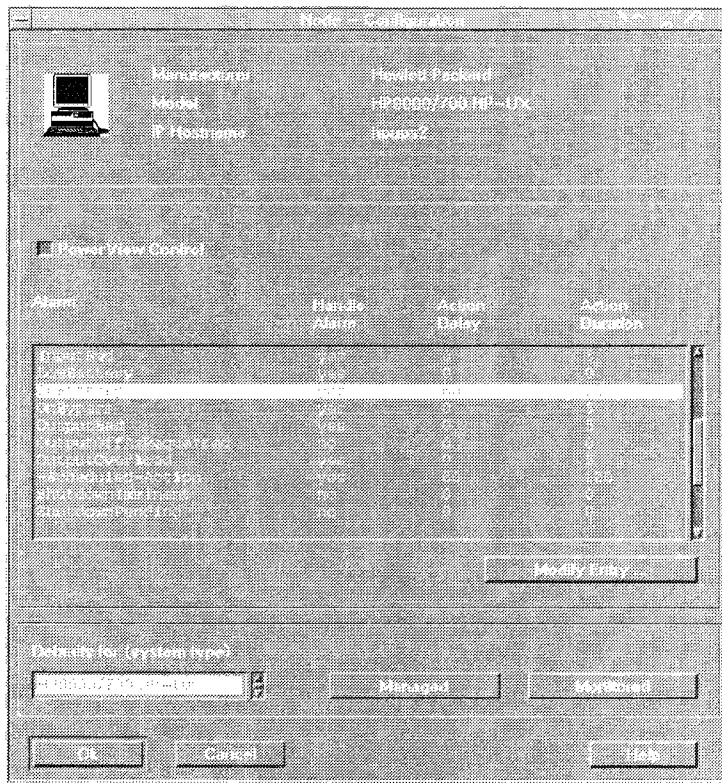

Figure E-3 Default Alarm Actions for Client 1

- 3 Select the alarm actions you want to use for Client 1. For instance, select the On-Battery alarm condition. Then proceed as follows:
 - 1 Click on Modify Entry.
 - 2 Set Action Delay to **30**. This grants the user of Client 1 a time period of 30 seconds for exiting the word processing application that usually runs on Client 1.
 - 3 Set Action Duration to **60**. This is the duration of the shutdown process of Client 1.
 - 4 Enter the following Message to User:
Please log off. UPS is running on battery.
 - 5 Specify the following action script:

/etc/shutdown

The Modify Entry panel now contains the following settings:

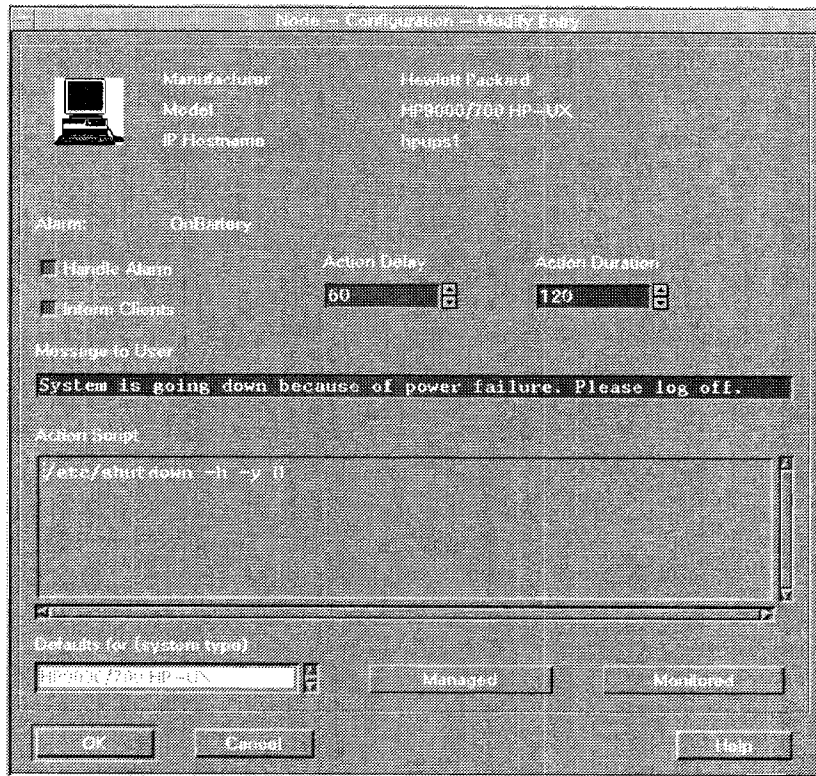

Figure E-4 Modified Alarm Actions for Client 1

- 4 Click OK to confirm.
- 5 Repeat this sequence of steps for Client 2 and Server. Use the settings shown in the "Alarm Actions" section below.

Defining Logical Dependencies

The procedure for defining logical dependencies is discussed in detail in *Chapter 10*.

Proceed as follows to define the logical dependencies shown in Figure E-2.

- 1 In the UPS Segment Map, click on the icon associated with Server.

Examples

Example 1

- 2 Pull down the Node menu and select Dependencies.
- 3 In the Logical Dependencies panel, click on Add
- 4 Enter the hostname or IP address for Client 2.
- 5 Click OK to confirm.
- 6 Click OK to confirm.

NOTE:

As shown below, Client 1 is not attached to Server. Therefore, no logical dependency needs to be defined between Client 1 and Server.

Alarm Actions

Once HP UPS Manager II is configured and all UPS connections and logical dependencies are defined, HP UPS Manager II continuously monitors the power supply status in the network. In the event of a UPS alarm, HP UPS Manager II checks its dependency database for dependent nodes and invokes the configured alarm actions.

Let us assume that a power failure occurs in the AC power line supplying the cluster shown above and that the following alarm actions are configured for the HP UPS Manager II managed nodes.

Client 1

Alarm	Handle Alarm	Message	Action Delay	Action	Action Duration
OnBattery	Yes	System is going down because of power failure. Please log off.	30 s	/etc/shut-down	60 s

Client 2

Alarm	Handle Alarm	Message	Action Delay	Action	Action Duration
OnBattery	Yes	System is going down because of power failure. Please log off.	50 s	/etc/shut-down	70 s
Server-Down	Yes	Please log off from "Server". "Server" is going down.	30 s	umount /disk	10 s

Server

Alarm	Handle Alarm	Message	Action Delay	Action	Action Duration
OnBattery	Yes	System is going down because of power failure. Please log off.	40 s	/etc/shut-down	100 s

These alarm event definitions define the following sequence of events (illustrated in the timing diagrams shown below):

- Client 1 (which is not logically linked to any server in our sample scenario) begins to shut down after 30 seconds. The duration of this shutdown process is 60 seconds, so that the total time elapsed is 90 seconds.
- As soon as the UPS device starts supplying battery-buffered power to Client 2 (commencement of the OnBattery alarm), the user of Client 2 is prompted to log off. The user has 30 seconds to exit any running applications and to log off from Client 2.
- 30 seconds after commencement of the OnBattery alarm condition, the Server-Down alarm condition begins to unmount the disk device. Upon completion of this unmount command, Client 2 no longer depends on Server. (This means that after a total time of 40 seconds, Server can begin to shut down as shown below.
- 10 seconds after the disk device is unmounted, (i.e. after a total of 50 seconds following commencement of the OnBattery alarm), the /etc/shutdown script begins

Examples

Example 1

to shut down Client 2.

- After a total time of 120 seconds, Client 2 is shut down.
- 40 seconds after commencement of the OnBattery alarm condition, the `/etc/shutdown` script begins to shut down Server. The duration of this process is 100 seconds, so that Server is shut down after a total time of 140 seconds.
- Once all computers dependent on UPS are down (after a total time of 140 seconds), UPS powers down.

Timing Diagrams

The following charts provide a chronological view of actions invoked by HP UPS Manager II. In this example, all system components dependent on UPS will be down after 140 seconds.

Client 1

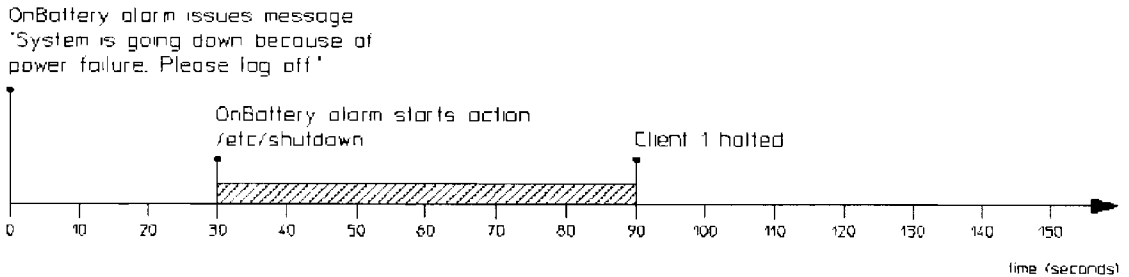

Figure E-5 **Timing Diagram for Client 1**

Client 2

ServerDown alarm issues message:
'Server is going down Please
log off '

OnBattery alarm issues message:
'System is going down because of
power failure Please log off.'

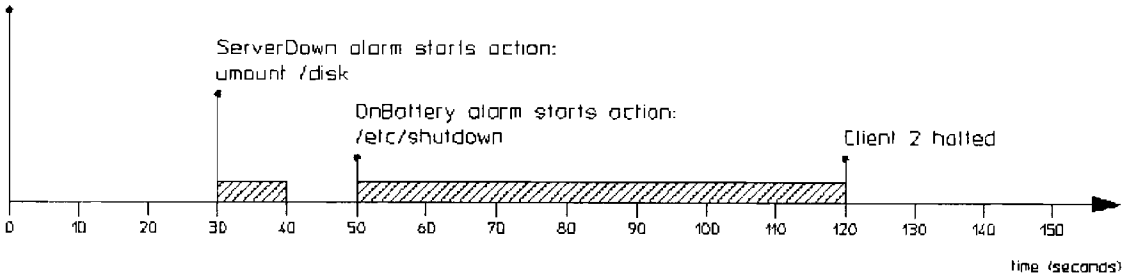

Figure E-6 Timing Diagram for Client 2

Server

OnBattery alarm issues message:
'System is going down because of
power failure Please log off '

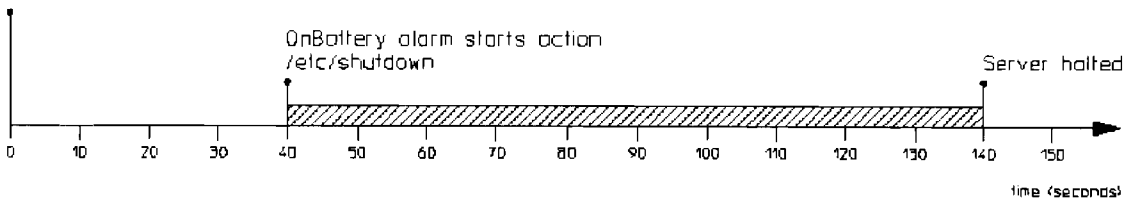

Figure E-7 Timing Diagram for Server

Examples
Example 1

UPS

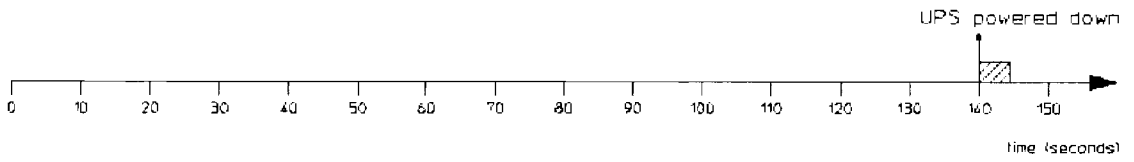

Figure E-8 **Timing Diagram for UPS**

Example 2

This example is based on a slightly more complex cluster. Its network and dependency structures are shown below.

Network Structure

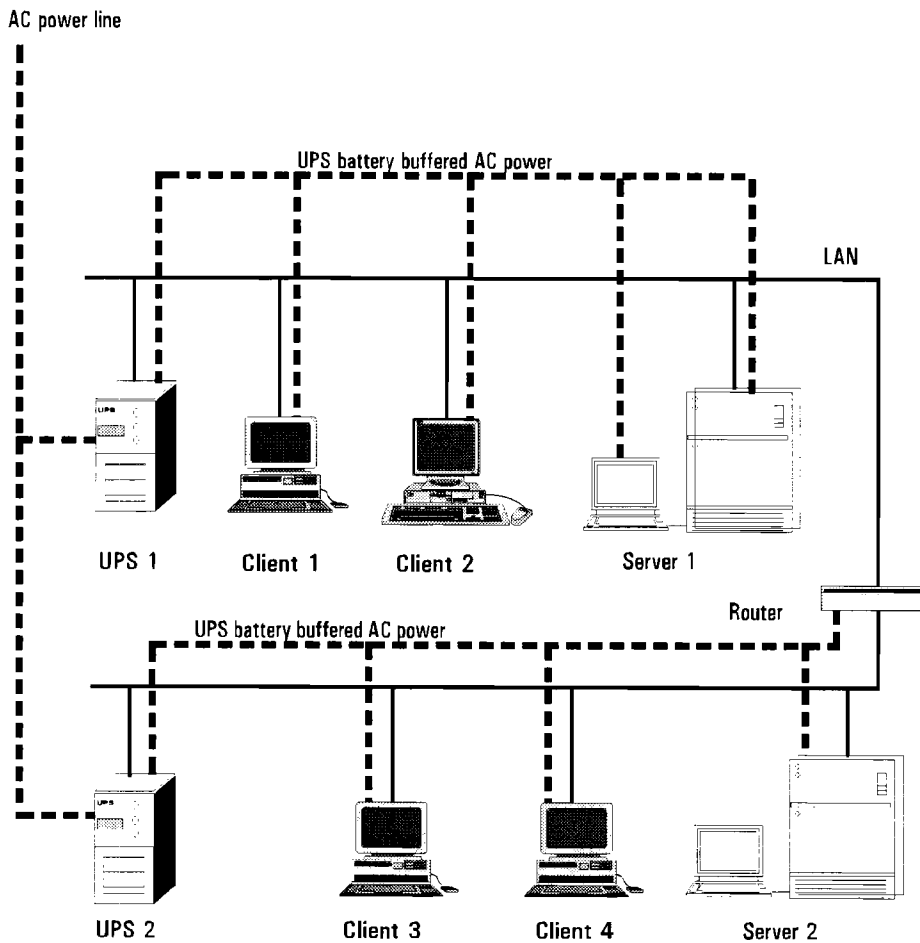

Figure E-9

Sample Network Structure

Examples
Example 2

Dependency Structure

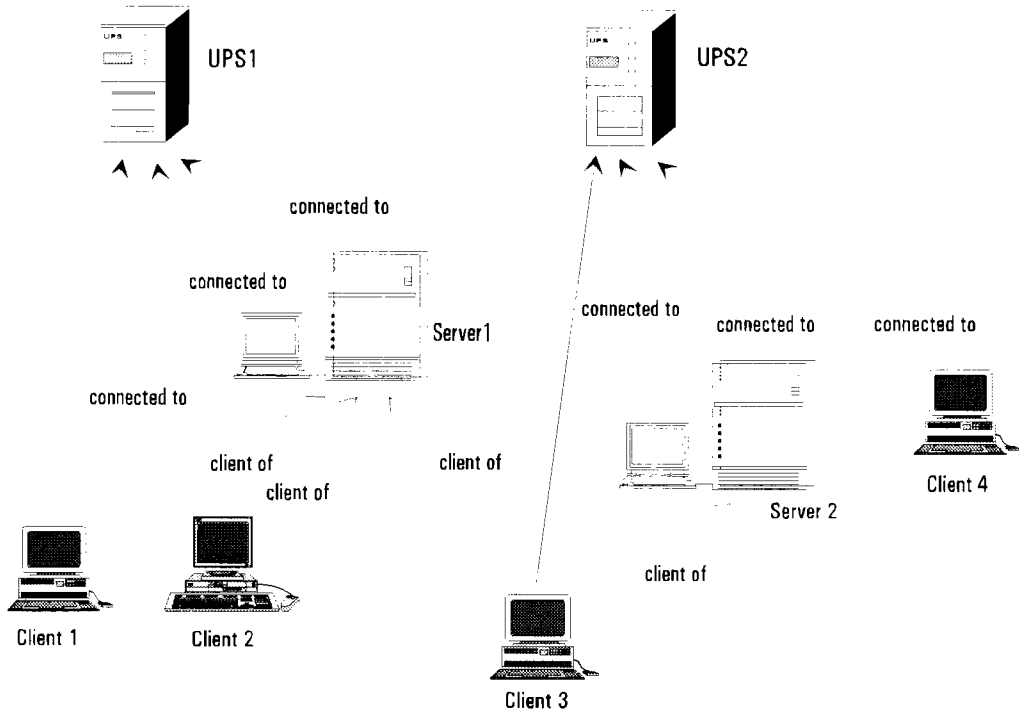

Figure E-10 Sample Dependency Structure

Alarm Actions

Let us assume that a power failure occurs in the AC power line supplying the cluster shown above and that the following alarm actions are configured for the associated nodes.

Client 1

Alarm	Handle Alarm	Message	Action Delay	Action	Action Duration
OnBattery	Yes	System is going down because of power failure. Please log off.	40 s	/etc/shut-down	60 s
Server-Down	Yes	Please log off from "Server1". "Server1" is going down.	20 s	umount /disk	10 s

Client 2

Alarm	Handle Alarm	Message	Action Delay	Action	Action Duration
OnBattery	Yes	System is going down because of power failure. Please log off.	50 s	/etc/shut-down	70 s
Server-Down	Yes	Please log off from "Server1". "Server1" is going down.	20 s	umount /rmt	20 s

Client 3

Alarm	Handle Alarm	Message	Action Delay	Action	Action Duration
OnBattery	Yes	System is going down because of power failure. Please log off.	60 s	/etc/shut-down	50 s
Server-Down	Yes	Please log off from "Server1". "Server1" is going down.	25 s	close_DB ^a	20 s
Server-Down	Yes	Please log off from "Server2". "Server2" is going down.	20 s	umount /rmt	10 s

a. The "close_DB" script is an example of an operator-defined shell script which closes a database accessed from Client 3.

Examples
Example 2

Client 4

Alarm	Handle Alarm	Message	Action Delay	Action	Action Duration
OnBattery	Yes	System is going down because of power failure. Please log off.	20 s	/etc/shut-down	20 s

Server 1

Alarm	Handle Alarm	Message	Action Delay	Action	Action Duration
OnBattery	Yes	System is going down because of power failure. Please log off.	40 s	/etc/shut-down	90 s

Server 2

Alarm	Handle Alarm	Message	Action Delay	Action	Action Duration
OnBattery	Yes	System is going down because of power failure. Please log off.	45 s	/etc/shut-down	100 s

Timing Diagrams

The following charts provide a chronological view of actions invoked automatically by HP UPS Manager II. In this example, all system components dependent on UPS1 will be down after 130 seconds. All system components dependent on UPS2 will be down after 145 seconds.

Client 1

ServerDown alarm issues message:
"Server1 is going down. Please
log off."

OnBattery alarm issues message:
"System is going down because of
power failure. Please log off."

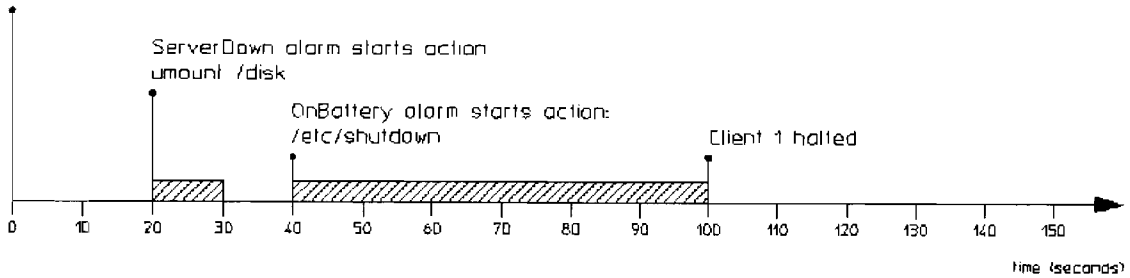

Figure E-11 Timing Diagram for Client 1

Client 2

ServerDown alarm issues message:
"Server1 is going down. Please
log off."

OnBattery alarm issues message:
"System is going down because of
power failure. Please log off."

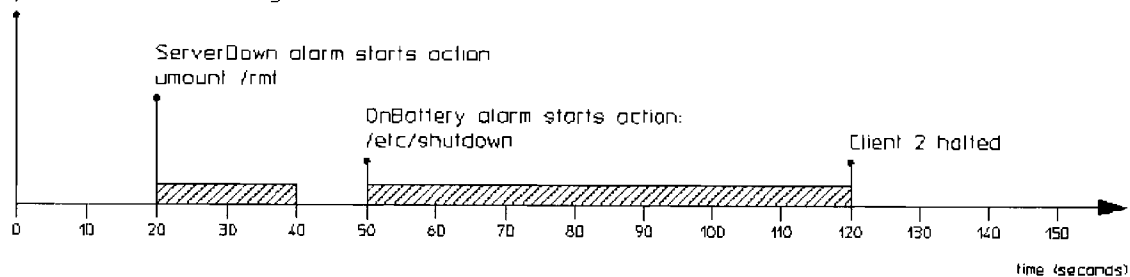

Figure E-12 Timing Diagram for Client 2

Examples
Example 2

Client 3

ServerDown alarm issues message:

'Server1 is going down. Please log off.'

ServerDown alarm issues message:

'Server2 is going down. Please log off.'

OnBattery alarm issues message:

'System is going down because of power failure. Please log off.'

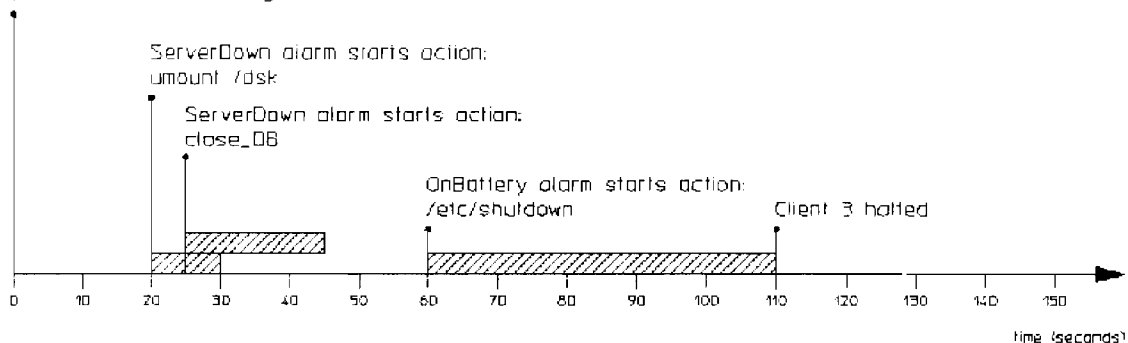

Figure E-13 **Timing Diagram for Client 3**

Client 4

OnBattery alarm issues message:
'System is going down because of power failure. Please log off.'

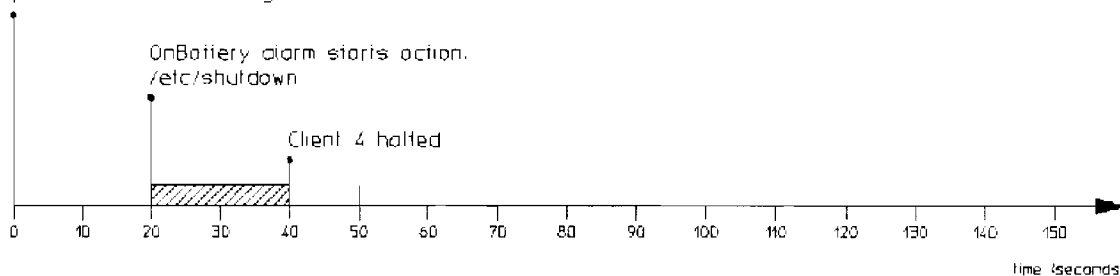

Figure E-14 **Timing Diagram for Client 4**

Server 1

OnBattery alarm issues message:
"System is going down because of
power failure Please log off."

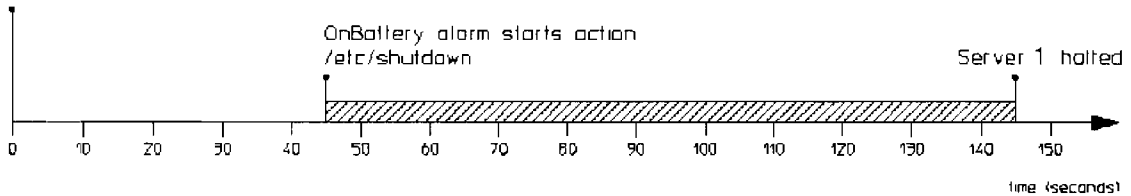

Figure E-15 Timing Diagram for Server 1

Server2

OnBattery alarm issues message:
"System is going down because of
power failure Please log off."

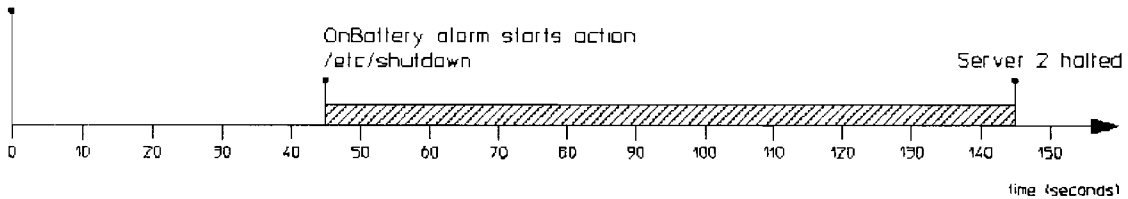

Figure E-16 Timing Diagram for Server 2

UPS 1

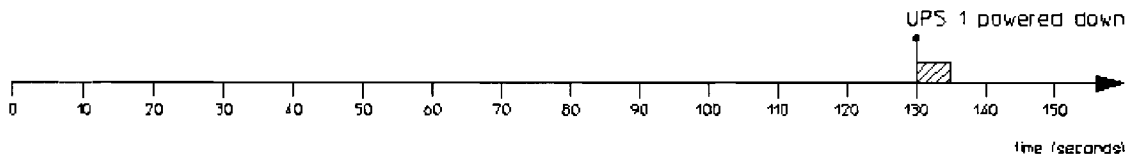

Figure E-17 Timing Diagram for UPS 1

Examples

Example 2

UPS 2

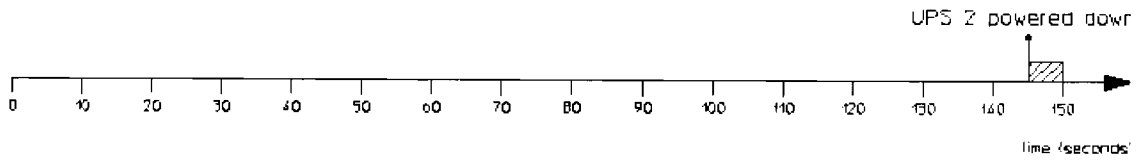

Figure E-18

Timing Diagram for UPS 2

Index

- A**
- AC line voltage, 13-5
- AC power cycles, 13-3
- access permissions
 - read community, 9-6
 - write community, 9-6
- action
 - delay, 11-6
 - duration, 11-7
 - messages, 11-7
 - prompts, 11-7
 - scheduling, 12-8
 - scripts, 11-7
- Add/Modify Event, 7-10
- alarm
 - handling, 11-6
 - informing clients, 11-6
 - name, 11-6
 - warning messages, 8-5
- alarm actions
 - example, E-8, E-14
- alarm conditions, A-5
 - modifying, 9-5
- AwaitingPower, A-15

- B**
- battery buffered AC power, 13-3
- battery time, 13-3
- battery voltage, 13-4
- BatteryBad, A-6
- Browse MIB, 7-10
- BypassBad, A-10

- C**
- ChargerFailed, A-12
- cleardb, C-3
- client
 - hardware requirements, 2-3, 3-3
- client/server
 - mapping logical dependencies, 10-7
- Close, 7-7
- Close Map, 7-9
- codewords
 - obtaining, 2-6, 3-6
- CommunicationLost, A-15
- community, 5-9
- components, 1-2
- concurrent scheduling events, 12-6
- configuring
 - UPS, 9-4
- connecting UPS, 4-3, 5-3
- Connecting UPS devices, 4-2, 5-2
- Copy, 7-9
- createdb, C-3
- customization
 - action scripts, 11-7
 - messages, 11-7
 - prompts, 11-7
- Cut, 7-9

- D**
- database maintenance
 - utilities, C-2
- defaults for global preferences, 8-6
- definition of terms, 1-3
- delay
 - action, 11-6
 - delay for alarms and corrective action, 9-4
- Delete, 7-9
- delnode, C-3
- dependencies
 - logical, example, E-7
- dependency structure
 - example, E-4, E-14
- DepletedBattery, A-7
- DiagnosticTestFailed, A-14
- disk space requirements
 - Management Station, 2-3, 3-3

Index

downtime scheduling, 12-6

E

Edit, 7-9
event logging, B-2
Exit, 7-9
External Graph, 7-10

F

FanFailure, A-13
File, 7-8
File Server Map, 7-6
file server submap, 10-8
frequency, 13-3
functionality, 1-7
FuseFailure, A-13

G

GeneralFault, A-14
global preferences, 8-2

H

handle alarm, 11-6
hardware requirements
 Management Station, 2-3, 3-3
Help, 7-11
Home, 7-7
HP PowerClient program, 1-4
HP UPS Manager managed node
 definition of term, 1-4
HP UPS Manager protected node
 definition of term, 1-4
HP UPS Manager II Management Station
 starting, 7-3

I

IETF RFC 1628 UPS-MIB II, A-2
Info, 7-9
inform clients, 11-6

input line voltage, 13-5

InputBad, A-8
installing, 2-2, 3-2
intervals, 8-3
introduction, 1-1

L

licensing policy, 1-10
load, 13-4
log file, B-2
logical dependencies, 1-5, 7-10, 10-7
 alarm message to dependent nodes, 11-6
 defining, 10-8
 example, E-7
logically dependent node
 definition of term, 1-5
LowBattery, A-7

M

Managed, 7-11
managed node, 1-4
Management Station, 1-3
 hardware requirements, 2-3, 3-3
 software requirements, 2-3, 3-3
 starting, 7-3
message to user, 11-7
Modify Action, 7-10
Monitored, 7-11
monitoring
 UPS device status, 13-2
Monitoring Station, 1-3

N

netdist, 2-9, 3-11
netdist server
 setting up, 2-7, 3-7
network requirements, 2-3, 3-3
network structure
 example, E-3, E-13

Index

Node Configuration, 7-9
Node Polling Interval, 8-3

O

obtaining codewords, 2-6, 3-6
OnBattery, A-6
OnBypass, A-10
Open Map, 7-8
Options, 7-11
OutputBad, A-9
OutputOffAsRequested, A-11
OutputOverload, A-9

P

Parent, 7-7
Paste, 7-9
peak delay, 9-4
polling intervals, 8-3
power cycles, 13-3
power management rules, 1-12
power scheduling, 12-2
PowerClient program, 1-4
problems, D-2
proxy agent, 1-6, 4-6
pulldown menu, 7-7

R

read community, 9-6
readdef, C-3
resetdb, C-3
rmdb, C-4
rules, 1-12

S

Schedule, 7-10
scheduled downtime, 12-6
-Scheduled-Action, A-18
scheduling, 12-2
 action, 12-8

 concurrent scheduling events, 12-6
 multiple (overlapping) schedules, 12-6
seconds on battery, 13-3
ServerDown, A-18
 example, E-9
shell scripts, 11-7
showdb, C-4
shutdown
 example, E-10, E-16
 UPS, 9-4
ShutdownImminent, A-16
ShutdownPending, A-16
SNMP, 1-6
SNMP agents, 5-7, 6-1
SNMP interface, 1-6, 2-4, 3-4, 5-3
SNMP interface module
 community, 5-9
 configuring, 5-7
 gateway address, 5-8
 hardware address, 5-8
 IP address, 5-7
 netmask address, 5-8
SNMP port, 9-6
software requirements
 Management Station, 2-3, 3-3
support user, 1-6
supported UPSs, 2-4, 3-4
system action time, 13-4

T

t, 7-9
TempBattery, A-8
temperature, 13-3
terms, 1-3
Test, 7-9
testing UPS devices, 14-2
TestInProgress, A-17
time estimate for UPS buffered AC power, 13-3
time intervals, 8-3

Index

timing diagram, E-10, E-16
traffic lights, 7-13
trap client, 10-4
troubleshooting, D-2

U

UPS

- battery voltage, 13-4
- configuring, 9-4
- disabling, 9-4
- enabling, 9-4
- hardware requirements, 2-4, 3-4
- load, 13-4
- monitoring device status, 13-2
- off, 12-2
- on, 12-2
- power scheduling, 12-2
- shutdown, 9-4
- specifying name, 9-4
- testing devices, 14-2
- time bar, 13-4

UPS Dependencies, 7-9

UPS Discovery Interval, 8-4

UPS Map Update Interval, 8-3

UPS off, 7-10

UPS on, 7-10

UPS Power Scheduling Interval, 8-4

UPS protected node

- definition of term, 1-4

- example, E-5

UPS Status Polling Interval, 8-4

UPS temperature, 13-3

UPS time, 13-3

UpsOffAsRequested, A-11

UpsOutputOff, A-12

UpsSystemOff, A-12

using

- general concepts, 7-2

utilities, C-2

V

View, 7-10

voltage, 13-5

W

warning messages on alarm, 8-5

write community, 9-6



Copyright © 1996
Hewlett-Packard Company
Printed in Germany 09/96
Printed on chlorine-free
bleached paper

**Manufacturing
Part No.
B4153-90002**



B4153-90002