

ISSUE NO. 10
SEPTEMBER, 1976

computer systems COMMUNICATOR

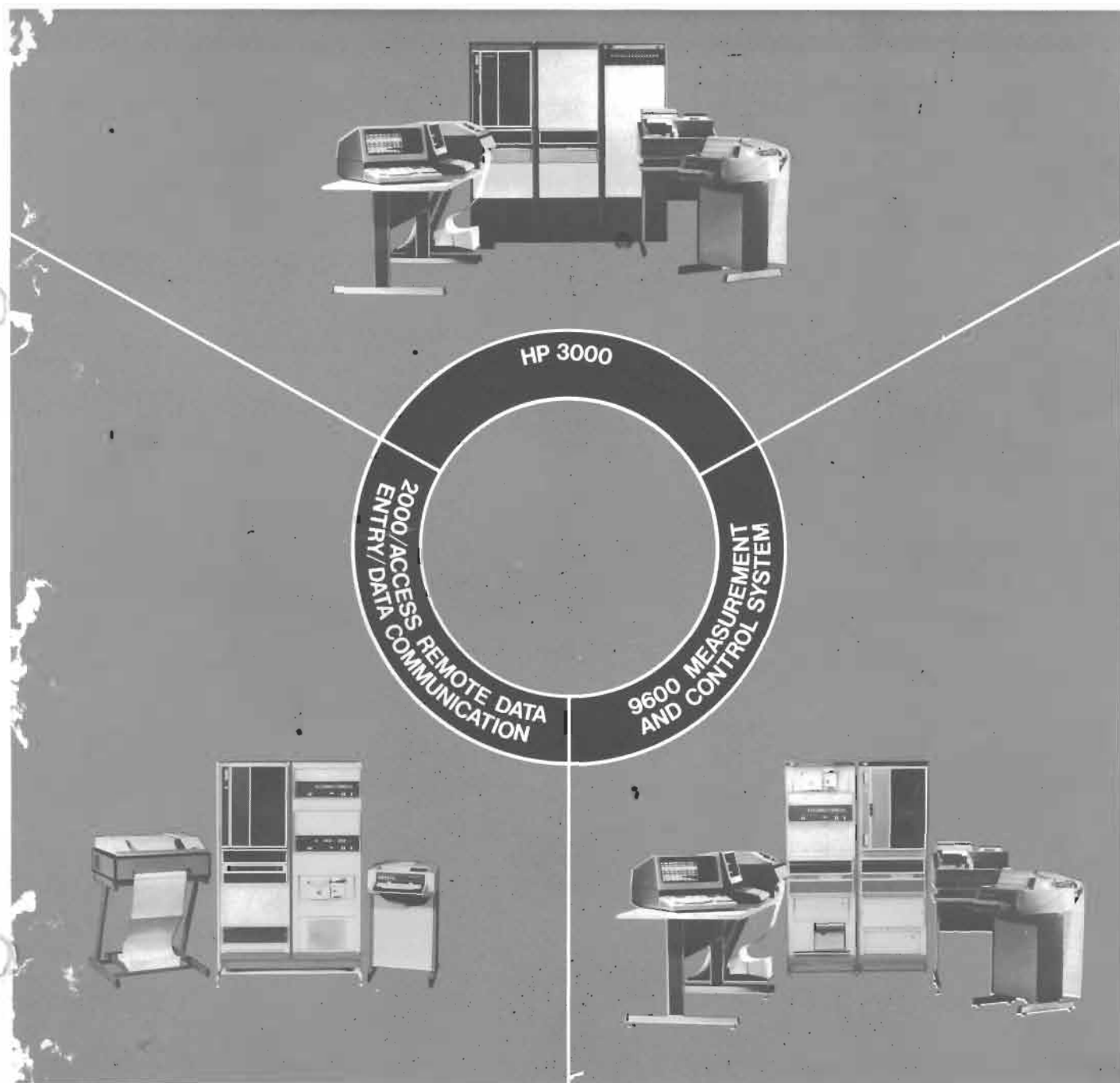

subscription information

Annual subscriptions consisting of 6 issues are available as outlined below.

I. CUSTOMERS WITH SOFTWARE MAINTENANCE AGREEMENTS OR SOFTWARE SUBSCRIPTION SERVICE AGREEMENTS (SOFTWARE SERVICE CONTRACT SUBSCRIPTIONS)

All Hewlett-Packard customers with Software Service Contracts are entitled to one BASE SUBSCRIPTION (1 copy per issue) at no additional charge. These customers may also buy ADDITIONAL SUBSCRIPTIONS whose purchase price is to be prorated against the remaining life of their Software Service Contract. A proration table appears on the ORDER FORM which is bound into this issue.

To receive a BASE SUBSCRIPTION at no charge as well as to purchase ADDITIONAL SUBSCRIPTIONS under the provisions of the Software Service Contract Program, complete the ORDER FORM and forward it to your local HP Sales and Service Office. Your local Customer Engineer will validate your order and mail it to the appropriate HP department.

Rates:	U.S.A.	NON-U.S.A.
BASE SUBSCRIPTION	NAC*	NAC*
ADDITIONAL SUBSCRIPTIONS (ea.)	\$12/yr.	**

- 1) ADDITIONAL SUBSCRIPTIONS must go to the same name and address as the BASE SUBSCRIPTION to qualify for the reduced rates.
- 2) ADDITIONAL SUBSCRIPTIONS ordered at a later date than the BASE SUBSCRIPTION must include, with the order form, a copy of the address label for proper identification.
- 3) Charges for ADDITIONAL SUBSCRIPTIONS will be prorated to expire with your Software Service Contract.
- 4) Orders for ADDITIONAL SUBSCRIPTIONS from a customer with a Software Service Contract will be verified by the Customer Engineer who will complete the "FOR HP USE ONLY" portion of the subscription form and direct the order to the appropriate HP department. The customer will be billed by his local HP Customer Engineering Department.

*No Additional Charge (NAC)

**Contact your local HP Customer Engineer for the price in the currency of your country.

II. CUSTOMERS WITHOUT SOFTWARE MAINTENANCE AGREEMENTS OR SOFTWARE SUBSCRIPTION SERVICE AGREEMENTS (MAIL ORDER SUBSCRIPTIONS)

Rates:	U.S.A.	NON-U.S.A.
BASE SUBSCRIPTION	\$48/yr.	***
ADDITIONAL SUBSCRIPTIONS (ea.)	\$12/yr.	***

- 1) ADDITIONAL SUBSCRIPTIONS must be ordered at the same time as the BASE SUBSCRIPTION and go to the same name and address as the BASE SUBSCRIPTION to qualify for the reduced rate.
- 2) The customer is to include payment (check, bank draft, money order, etc.) with the order. This is a Direct Mail Order procedure; please do not send a purchase order to HP.
- 3) Complete the ORDER FORM as directed and mail together with your payment to:

Hewlett-Packard Co.
Mail Order Dept.
P.O. Drawer No. 20
Mountain View, California 94043
U.S.A..

SUBSCRIPTION CORRESPONDENCE

Address all correspondence relating to **COMMUNICATOR** subscriptions to:

Subscription Service Manager
Hewlett-Packard Company
Mail Order Dept.
P.O. Drawer No. 20
Mountain View, California 94043
U.S.A.

***The international customer is encouraged to also use HP's Direct Mail Order System by remitting a bank draft in U.S. dollars according to the order procedure outlines above. If the currency regulations in the customer's country disallow the purchase of bank drafts in American dollars, or if the customer does not have ready access to the required banking services, the customer may order subscriptions from the local HP Sales and Service Office through his Customer Engineer. The customer should contact his HP Office for the price of the subscription in the currency of his country then complete the ORDER FORM and forward it together with payment to his local HP Office.

HP Computer Museum
www.hpmuseum.net

For research and education purposes only.

**HEWLETT-PACKARD
COMPUTER SYSTEMS COMMUNICATOR ORDER FORM**

Please Print:

Name _____ Title _____
 Company _____
 Street _____
 City _____ State _____ Zip Code _____
 Country _____

<input type="checkbox"/> MAIL ORDER SUBSCRIPTIONS BASE SUBSCRIPTION \$ _____ _____ ADDITIONAL SUBSCRIPTION(S) \$ _____ No. _____ TOTAL AMOUNT ENCLOSED \$ _____	<input type="checkbox"/> SOFTWARE SERVICE CONTRACT SUBSCRIPTIONS BASE SUBSCRIPTION (NO ADDITIONAL CHARGE) NAC _____ _____ ADDITIONAL SUBSCRIPTION(S) \$ _____ No. _____ TOTAL AMOUNT YOU WILL BE BILLED \$ _____
---	--

FOR HP USE ONLY

SUPPORT OFFICE NUMBER _____ ORDER DATE _____
 APPROVED BY _____ C.E. NUMBER _____
 SERVICE CONTRACT NUMBER _____ EXPIRATION DATE _____
 AUTHORIZED TOTAL NUMBER OF SUBSCRIPTIONS _____
 CUSTOMER'S HP OPERATING SYSTEM _____

Printed 4/76

TABLE OF PRORATED \$ AMOUNT DUE PER ADDITIONAL SUBSCRIPTION
 (Use only for ordering ADDITIONAL SUBSCRIPTION(S) against an existing Software Service Contract)

Months Remaining in Service Contract												
	1	2	3	4	5	6	7	8	9	10	11	12
Cost of Each ADDITIONAL SUBSCRIPTION	1.00	2.00	3.00	4.00	5.00	6.00	7.00	8.00	9.00	10.00	11.00	12.00

INSTRUCTIONS FOR ORDERING COMMUNICATOR

All Hewlett-Packard customers with Software Service Contracts are entitled to one BASE SUBSCRIPTION (1 copy per issue) at no additional charge. These customers may also buy ADDITIONAL SUBSCRIPTIONS whose purchase price is to be prorated against the remaining life of their Software Service Contract.

Customers who do not have Software Service Contracts may purchase Mail-Order Subscriptions through HP's Direct Mail Order System.

A. MAIL-ORDER SUBSCRIPTION(S)

1. Complete name and address portion of ORDER FORM.
2. Compute amount due:
 - a) Annual Base Subscription (6 issues) \$ 48.00
 - b) _____ Additional Subscriptions*
@ \$12.00 ea. \$ _____

 - c) Total Order Amount (a + b) \$ _____
 - d) Transfer number of ADDITIONAL SUBSCRIPTIONS and all dollar amounts to ORDER FORM.
3. Mail check or bank draft with ORDER FORM to:

HEWLETT-PACKARD CO.
MAIL ORDER DEPARTMENT
P.O. DRAWER #20
MOUNTAIN VIEW, CA. 94043
U.S.A.

B. SOFTWARE SERVICE CONTRACT SUBSCRIPTION(S)

1. Complete name and address portion of ORDER FORM.
2. Compute amount due: (BASE SUBSCRIPTION is at no additional charge.)
 - a) Annual Base Subscription (6 issues) \$ 0.00
 - b) _____ Additional Subscriptions*
\$ _____

Prorate the dollar amount to make the ADDITIONAL SUBSCRIPTIONS EXPIRE WITH YOUR Software Service Contract. (SEE TABLE)

 - c) Total Order Amount (a + b) \$ _____
 - d) Transfer number of ADDITIONAL SUBSCRIPTIONS and all dollar amounts to ORDER FORM.
3. Forward ORDER FORM to your local HP Customer Engineering Representative. Your order will be approved and forwarded to the appropriate department. You will be billed for any ADDITIONAL SUBSCRIPTIONS by your local HP office.

C. SPECIAL INSTRUCTIONS FOR INTERNATIONAL CUSTOMERS

1. International customers who do not have Software Service Contracts are encouraged to use HP's Direct Mail Order System by remitting a bank draft in U.S. dollars according to the ordering procedures outlined in Instruction A above. Optionally, international customers may purchase the **Communicator** through their local HP Sales and Service Office. The customer should contact his HP Office for the subscription prices in the currency of his country, then complete the Order Form and forward it together with payment to his local HP Customer Engineering Department.

1. International customers with Software Service Contracts should follow the ordering procedure outlined in Instruction B above. If the customer wishes to purchase ADDITIONAL SUBSCRIPTIONS, he should contact the local HP Office for the subscription price in the currency of his country, then submit the ORDER FORM. The customer will be billed for ADDITIONAL SUBSCRIPTIONS by his local HP Office.

*All ADDITIONAL SUBSCRIPTIONS will be sent to the same name and address as the BASE SUBSCRIPTION.

editor's note

The 2000 technical editors promised us in last issue's Communicator we would receive software and documentation worth waiting for. Well — they came through with their promise! Hewlett-Packard has announced new software capabilities for the HP 2000 Computer System. You will find information describing enhancements to the operating system, a new source data entry package for the HP 2640 display terminals, and new documentation which incorporates these software capabilities.

If you have any comments on our new software for the 2000 Computer System, as well as any ideas on topics you would like to see discussed in future issues of the Communicator, please let us know.

Address your correspondence to:

Editor
Computer Systems Communicator
HP General Systems Division
5303 Stevens Creek Blvd.
Santa Clara, CA 95050

OOPS !

The 3000 documentation section (on page 402 of the July 1 Communicator) shows the Console Operator's Guide (30000-90013) as a 3000 CX and Series II Manual. The "X" was accidentally entered in the 3000 CX column; the manual is *only* a Series II manual.

Articles from this publication may not be reproduced in any form or by any means without prior permission of the Editor.

contents

ABOUT THE HP 2000

Software Tips	
Using A 2644 With CAI Applications	444
Bulletins	
Status Of IMF, IDF, And HP Math Products	
On The 2000F And 2000 Access	444
HP 2000 BASIC Pocket Guide	444
HP 2000 Source Data Entry Reference Manual	444
The New EDITOR/2000 Reference Manual	445
Software Updates	
CIS 2000 Update for 2000F and 2000 Access	445
Documentation	447
Training Schedules	449

ABOUT THE HP 3000

Software Tips	
The Series II 2780/3780 Emulator	450
Sort-A Vs Sort-B in COBOL	450
Bulletins	
SIS/3000 and SAS/3000	450
HP 3000 Users Group Meeting	451
HP 3000 Users Group Membership	451
Software Updates	
MPEII, HP 32002A.00.02	452
MPEII, HP 32002A.00.03	452
2100 Cross Assembler, HP 32223A.01.00	454
2780/3780 Emulator, HP 30130B.01.05	455
BASIC/3000, HP 32101B.00.02	455
BASICOMP/3000, HP 32103B.00.01	456
COBOL/3000, HP 32213B.02.01	457
Compiler Library/3000, HP 32211C.04.02	458
Compiler Library/3000, HP 32211D.00.02	458
DEL/3000, HP 32206A.01.00	458
FCOPY/3000, HP 32212A.01.02	458
Fortran/3000, HP 32102B.00.03	459
QUERY/3000, HP 32216A.03.01	459
RPG/3000, HP 32104A.02.06	459
RPG/3000, HP 32104A.02.07	459
Scientific Library, HP 32205B.00.01	459
Sort/3000, HP 32214B.01.01	460
Documentation	460
Training Schedule	463
FEATURE ARTICLE	
Featuring — New Software Enhancements	
For HP 2000	465
ABOUT THE HP 9600	
Software Tips	
Distributed Systems Timeout Values	476
Indirect Addressing	476
7970E Bootstrapping	476
Using Multiple CPU's With One 7905A Disc and	
RTE II/III	476
Format of Data Files in Multi-User Real Time	
BASIC	477
Fortran IV I/O Using ASSIGN Statements	480
How To Optimize The Search Time In Your	
IMAGE/1000 Data Base	480
Know Your RTE, Part 4	482
Software Sam	484
Bulletins	
New Training Course Data Sheets	484
New Releases From The 2100/21MX Contributed	
Library	484
Software Updates	
RTE-II/RTE-III	486
RTE Drivers	487
DOS-IIIB Modules	487
Documentation	488
Training Schedule	492



software tips

USING A 2644 WITH CAI APPLICATIONS

Anna Holland
HP General Systems

If your 2644 terminal has an alternate character set and you are running CAI applications, you must first set your 2644 to use the ROMAN character set as your alternate character set. This is accomplished by depressing the ESC button, right parenthesis, @. Now proceed as usual. If the reset button is depressed, you must again perform the above sequence.

bulletins

STATUS OF IMF, IDF, AND HP MATH PRODUCTS ON THE 2000F AND 2000 ACCESS

Anna Holland
HP General Systems

2000F: (last applications software release: FALL 1974)

IDF: No changes

IMF: No changes

These Fall 1974 versions have been performing without problems for two school years.

MATH: (last release of application: FALL 1974)

There are two cosmetic, non-fatal "bugs," both in the MATHR (report) program:

1. Incorrect block number printed in the Student Report under certain circumstances.
2. A particular block and year are omitted from a message in the Daily Report.
3. Using the proctor commands ALTER ALL and ALTER <group name> for TYPE (not a usage specified in the manual) will cause errors in the student records which will necessitate reloading of the student files. Until a fix is available for this problem, these commands should *NOT* be used.

2000 Access: (Software release: FALL 1975)

IDF: There are several known problems which involve the following programs: IDAF, IDSF, EDDOC, and OUTCOM. These are of a minor nature and involve one-line changes.

IMF: No changes

HP MATH:

1. Under certain circumstances, incorrect block number is reported in the Student Report.
2. The ALTER ALL and ALTER <group name> commands problem which appeared in the 2000F version also appears in the Access version.

These are the only reported problems. If you are aware of any others, please report them to your Hewlett-Packard Customer Engineer.

HP 2000 BASIC POCKET GUIDE

Mary Eicher
HP General Systems

The new HP 2000 BASIC Pocket Guide assists the programmer by providing command and statement information such as format, parameters, and a discussion of the general use of each command or statement. Security and access information is also provided as are lists of the predefined functions, device codes, and ASCII decimal equivalents. The part number is 22687-90003 and the price is \$1.50.

HP 2000 SOURCE DATA ENTRY REFERENCE MANUAL

A reference manual describing Source Data Entry/2000 (SDE/2000), is now available.

SDE is an application for entering data into files on the HP 2000 system, using 2640 and 2644 terminals. (You can find more details on SDE in the feature article of this issue.)

The manual is directed to the forms designer who transcribes business forms to the terminal, the terminal operator who enters data to the forms, and the applications programmer who uses the data files produced by SDE.

Order the manual from your local HP sales office, or use the Direct Mail Order form in the back of the Communicator.

Price: \$5.00 Part No. 20243-90001

THE NEW EDITOR/2000 REFERENCE MANUAL

Mary Eicher
HP General Systems

The EDITOR/2000 Reference Manual describes a versatile new text editing product. The manual instructs the reader in the format and use of the many EDITOR/2000 commands and provides information on how to set up files with the EDITOR, how to manipulate text, format output, use tape cassettes with the EDITOR, and many other related operations.

A feature of special note is that the manual itself was prepared with the EDITOR/2000 and is an example of the type of documentation that the EDITOR may generate. The HP part number is 22701-90001.

software updates

CIS 2000 UPDATE FOR 2000F AND 2000 ACCESS

There is a new release of CIS 2000-Revision 1633. If you are not already running this new revision, be sure to contact your HP Customer Engineer to get it installed. With the new revision, all of the following problems have been corrected.

CIS006

When "OVERFLOW" message prints, the program asks for positions to the right of the decimal point and places the wrong length in the table. Deleting that element later with a delete command, subtracts the incorrect length from the logical record length.

CIS007

1. Someone with read only access could initialize an uninitialized edit file.
2. STRING OVERFLOW occurs if more than two characters are entered at ENTER EDIT FILE NUMBER?

CIS011

Lower case "//STOP" does not work.

CIS012

1. Some valid point values are not accepted.
2. Lower case "//STOP" does not work.

CIS100

The error summary is printed an extra time for each link error encountered.

CIS101

1. STRING OVERFLOW will occur when an invalid term is entered.
2. The operation C (CHECK) destroyed the pointers in the current chains (head of chain) when the CHECK was done in another chain. This resulted in the message NO CHAIN when indeed there was a chain. This could only happen while processing NAME chains.
3. BAD IDENTIFIER is printed for each record in the chain when option C(CHECK) is taken for student ID chains.
4. If any user of CIS101 is correcting data base errors, it is possible to have conflict with other CIS users who are directly or indirectly altering chains. The result of this is to introduce additional chain errors. This can only occur if the user of CIS101 chooses not to lock the file in batch mode.

CIS202

A massive deletion of students locks the file in "normal" mode instead of "batch" mode. This causes the "SHORT WAIT" message to be printed at other terminals attempting to update until CIS202 is finished.

CIS204

A user with read only capability could copy a course master file.

CIS205

1. Program fails to unlock course master file after the "file full" message is printed.
2. A wrong error message is printed when a "begin" time is entered which exceeds the "end" time (and vice versa).

CIS300

1. Registration was allowed even though it had been "suspended".
2. A SUBSCRIPT OUT OF BOUNDS IN LINE 1680 message is printed when entering data such as: 137, , , 139.

CIS301

Report options 2, 3 and 4 abort. (Access only)

CIS302

Report options 2, 3 and 4 abort. (Access only)

CIS306

1. When class lists are printed using the restart or ALL option, the program will terminate if a class to be printed has been deleted from the data base recently.
2. Cancelled classes are printed.

CIS401

A user with read only capability could change an historical grade.

CIS403

1. Lower case "//STOP" does not work.
2. A wrong qualifier for file name in message. (Access only)
3. Pages are longer than 11 inches (i.e. 13+) per page.

CIS405

1. The first student on a restart is not checked properly. This makes it possible to print a grade card for the first student even though the first student should not have a grade report printed.
2. Courses worth zero units and not having a final grade are not getting printed.
3. Lower case "//STOP" does not work.

CIS406

1. No students received midterm grade reports.
2. Courses worth zero units with a final grade are not getting printed.
3. Lower case "//STOP" does not work.

CIS407

1. The first student on a restart may receive a label even though this student is not registered for the term.
2. Courses with zero units and no final grade are not getting printed.
3. Transcript Labels can be run for mid term grades. Even though no labels are printed, all records are examined.
4. Lower case "//STOP" does not work.

CIS408

Lower case "//STOP" does not work.

CIS410

1. The first student on a restart was not being checked properly, allowing this student to be printed sometimes when he should not have been printed.
2. Lower case "//STOP" does not work.

CIS500

Use QUERY TERMINAL OPERATOR ERROR. DISPLAY ELEMENT?, 12, 3, 4 = ERROR. Subscript out of bounds in line 5220.

CIS501

A sort of a 1 record data does not work — END OF RECORD IN LINE 5340.

CIS502

1. Literals that were too long (>31) to be printed in CIS503 were not being detected.
2. SUBSCRIPT OUT OF BOUNDS IN LINE 3470 when entering 1H,,1.
3. Some user input is not converted to uppercase and "//STOP" does not work in some places.

CIS503

1. SUBSCRIPT OUT OF BOUNDS IN LINE 3310 when no header statements are specified.
2. A maximum of 31 characters were being printed for any single literal.

- 3. Printing of a report is impossible unless it has been sorted. (Access only)
- 4. When printing two fields in adjacent print columns extra carriage returns between fields slows down printing.

CIS906

Lower case "//STOP" does not work.

CIS907

PROGRAM CSAVED message given by the operating system while trying to APPEND the program.

CIS908

Error code of 14 (instead of 15) was returned when a data element being updated did not match any values in the edit file.

CIS909

Error code of 14 (instead of 15) was being returned when a data element being updated did not match any values in the edit file.

CIS500

If too many compare values are entered when specifying criteria (>41), the appropriate manage is printed but the procedure is terminated incorrectly.

CIS503

The printing of alpha numeric fields with edit mask that contains X's does not work properly.

about the HP 2000

documentation

The following tables list currently available customer manuals for HP 2000 Systems products. This list supersedes the list in the last issue of the **Communicator**.

The most recent changes to the tables are indicated for easy reference. Prices are subject to change without notice.

Copies of manuals and updates can be obtained from your local Sales and Service office. The address and telephone number of the office nearest to you are listed in the back of all customer manuals.

Update packages are free of charge. If you require an update package only, send your request to:

Software/Publications Distribution
5303 Stevens Creek Blvd.
Santa Clara, Ca 95050

Customers in the U.S. may also order directly by mail. Simply list the name and part number of the manual(s) you need on the Corporate Parts Center form supplied at the back of the **Communicator**.

A few words about documentation terms:

- New** A new manual refers only to the first printing of a manual. When first printed, a manual is assigned a part number.
- Revised** A revised manual is a printing of an existing manual which incorporates new and/or changed information in its contents. For example, a manual is revised when an update package is incorporated into the manual: the manual gets a new print date and the update package disappears. Note that a revision to a manual effectively obsoletes the previous version of the manual.
- Update** An update package is a supplement to an existing manual which contains new and/or changed information. Updates are issued when information must get to customers, yet it is inappropriate to issue a revised manual. An update has no part number; it is automatically included when you order the manual with which it is associated.

about the HP 2000

PART NUMBER	2000 E	2000 F	HP 2000	MANUAL TITLE	PRICE [†]	PUBLICATION DATE	CURRENT UPDATE
02000-90055		X		2000C/2000F IDF Author's Manual	\$ 8.50	1/73	8/74
02000-90080		X		2000E to 2000F Conversion Guide	1.00	4/76	
19665-90001			X	2000/F to 2000/Access System Upgrade Kit and Conversion Program Manual	2.00		
19665-90002			X	2000/F to 2000 Access System Educational Application Upgrades	1.00	2/76	
22687-90001			X	Access BASIC Reference Manual, HP 2000	10.00		
22687-90005			X	Access Operator's Manual, HP 2000	10.00		
22687-90007			X	Access System Operator's Pocket Guide	1.50		
22687-90003			X	BASIC Pocket Guide, HP 2000	1.50		
02000-90048	X			BASIC/2000 Level E Reference Manual, Timeshared	10.00	9/75	
02000-90049	X			BASIC/2000 Level E System Operator's Manual, Timeshared	5.00	9/74	8/75
5952-4490	X			BASIC/2000 Level E Pocket Guide, Timeshared	0.15	10/74	
02000-90073		X		BASIC/2000 Level F Reference Manual, Timeshared	7.50	12/75	
02000-90074		X		BASIC/2000 Level F System Operator's Manual, Timeshared	10.00		
5952-4491		X		BASIC/2000 Level F Pocket Guide, Timeshared	0.15	8/75	
24387-90001		X		Basic Analysis and Mapping Program Manual	18.00	6/74	5/75
24387-90002		X		Basic Analysis and Mapping Program Pocket Guide	1.00	6/74	
24384-90001		X	X	College Information System -- System Overview	5.00	6/74	
24384-90003		X	X	College Information System Reference Manual	19.00	9/75	
24384-90005		X	X	College Information System -- Technical Manual	95.00	5/75	
24383-90001		X		Course Writing Facility Reference Manual	15.00	5/74	
22692-90001			X	Course Writing Facility Reference Manual	16.50	12/75	
5951-1381		X		DOS-M/2000C Timeshared BASIC File Handler	1.00	5/71	
22701-90001			X	EDITOR/2000 Reference Manual	7.00		
20352-90001		X		Educational Budget and Accounting System -- System Overview	5.00	6/74	
20352-90002		X		Educational Budget and Accounting System -- Reference Manual	10.00	3/75	4/76
20352-90003		X		Educational Budget and Accounting System -- Technical Manual	75.00	3/75	
20353-90001		X		Educational Payroll System -- System Overview	3.50	10/74	
22700-90001			X	FCOPY/2000 Reference Manual	4.50	1/76	
22693-90003			X	HP MATH Curriculum Guide	17.50	7/75	
22693-90002			X	HP MATH for HP 2000 Access Proctor's Manual	6.50	7/75	
22693-90001			X	HP MATH Teacher's Handbook	5.50	7/75	
20310-90007		X		HP MATH Curriculum Guide			
20310-90005		X		HP MATH Proctor's Manual	20.00	7/74	
20310-90001		X		HP MATH Teacher's Handbook	5.00	9/74	
22691-90003			X	Instructional Dialogue Facility for HP 2000 Access Author's Manual	5.00 13.00	9/74 9/75	
22691-90004			X	Instructional Dialogue Facility for HP 2000 Access Author's Pocket Guide	3.00	9/75	
22691-90002			X	Instructional Dialogue Facility for HP 2000 Access Course Developer's	5.00	9/75	
22691-90001			X	Instructional Dialogue Facility for HP 2000 Access Proctor's Manual	6.00	9/75	
20309-90005		X		Instructional Dialogue Facility Author's Pocket Guide	3.50	10/74	
20309-90003		X		Instructional Dialogue Facility Course Developer's Manual	6.00	8/74	
20309-90001		X		Instructional Dialogue Facility Proctor's Manual			
22690-90001			X	Instructional Management Facility for HP 2000 Access Proctor's Manual	10.00 6.50	9/74 9/75	
22690-90002			X	Instructional Management Facility for HP 2000 Access System Manager's Reference Manual	4.50	9/75	
20308-90001		X		Instructional Management Facility Proctor's Manual	7.00	9/74	

PART NUMBER	2000 E	2000 F	HP 2000	MANUAL TITLE	PRICE†	PUBLICATION DATE	CURRENT UPDATE
20308-90003		X		Instructional Management Facility System Manager's Manual	5.00	10/74	
22687-90009			X	Learning Timeshare BASIC	3.50	5/76	
20243-90001			X	Source Data Entry/2000 Reference Manual	5.00	3/76	
20240-90001			X	Telecommunications Supervisory Package/2000 Manager's Manual	5.00	1/76	
20240-90002			X	Telecommunications Supervisory Package/2000 User's Manual	3.50	1/76	
20311-90001		X		Timeshared Graphics for Tektronix Terminals	7.00	8/74	
20311-90003		X		Timeshared Graphics Plotting Package	5.00	8/74	

*N = New Manual (Refer to the Bulletin section)
 *R = Revised Manual
 † Prices listed are subject to change without notice.

training schedule

The schedule for customer training courses on General Systems Division Products is outlined below and in the HP 3000 section of this publication. Included here are 2000 Access courses for the 4 month period, September through December 1976.

GENERAL SYSTEMS DIVISION COURSE SCHEDULE

September - December 1976

Course Dates and Training Center Location

COURSE NUMBER	COURSE TITLE	LENGTH	PRICE	GENERAL SYSTEMS SANTA CLARA	EASTERN TRAINING CENTER - ROCKVILLE
22973A	2000 Access, Data Entry, File Management and RJE	5 days	\$500	10/25/76	9/13/76

Registration

Requests for enrollment in any of the above courses should be made through your local HP Sales Office. Your Sales Representative will supply the Training Registrar at the appropriate location with the course number, dates, and requested motel reservations. Enrollments are acknowledged by a written confirmation indicating the training course, time of class, location and accommodations reserved.

Cancellations

In the event you are unable to attend a class for which you are registered, please notify the Training Center Registrar immediately in order that we may offer your seat to another student. To avoid paying for a reservation which you do not use, we must receive notification of your cancellation no later than two weeks before the class begins.

Accommodations

Students provide their own transportation, meals, and lodging. The Training Registrar will be pleased to assist in securing motel reservations at the time your Sales Office requests a registration.

EASTERN TRAINING CENTER	GENERAL SYSTEMS DIV. TRAINING CENTER
Hewlett-Packard 4 Choke Cherry Road Rockville, Maryland 20850 (301) 948-6370	Hewlett-Packard 5303 Stevens Creek Blvd. Santa Clara, Calif. 95050 (408) 249-7020

software tips

THE SERIES II 2780/3780 EMULATOR

Jim Willits
HP General Systems

The 2780/3780 Emulator has been rewritten for the Series II. This was necessary because of the new I/O scheme implemented on the Series II.

The commands for the Series II 2780/3780 Emulator are the same as used on the HP 3000CX. There are two additional parameters available with the #RJLINE command. The DEV parameter allows specification of the device class name for the line. The TRACE parameter controls a line trace of all characters sent or received. The tracing may be selective on the type of events recorded by supplying a parameter. The trace data is written into a disc file and can be printed later using a program called CSDUMP.PUB.SYS.

Another new feature is the Control-Y interrupt. If you run the emulator from a session any input or output command can be terminated by using the Control-Y key at the terminal. This is particularly advantageous when it's desirable to send a job and a long line printer listing is being received. The listing can be interrupted by using the Control-Y key and then the job can then be transmitted.

The sequence of commands to do this when communicating to an IBM HASP system follow:

```
#RJOUT *LP    initial receive of listing
Control-Y     interrupts listing
#RJOUT *LP    receive HASP banner page
#RJIN JOB     send the job
#RJEOD
#RJOUT        receive the job number
#RJOUT *LP    receive the remainder of the listing
```

Note: Since the Series II version of the 2780/3780 Emulator is a complete rewrite with new drivers, it is incompatible with the HP 3000CX operating system. Consequently, these new features are not available on the HP 3000CX.

SORT-A VS SORT-B IN COBOL

John Pavone
HP General Systems

Under Sort-A a definition of the same file for both source and destination was permitted with no requirement other than to include it as the USING and GIVING file in the Cobol Calling Sort Statement.

As a result of changes in the Sort-B program, attempts to run a COBOL program written to use Sort-A conventions would cause a RUN time file system ERROR 91- "The calling process requested access to a file to which another process has exclusive access".

To overcome the incompatibility, use a FILE equation, at RUN time, to define the common file as shared.

EXAMPLE

Assume a file "DATA" is to serve as both the source and destination file of a SORT operation.

FILE SECTION

```
SELECT IFILE ASSIGN TO "DATA,DA".
SELECT SFILE ASSIGN TO "DATA,DA".
```

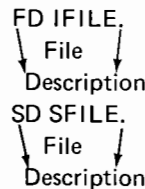

SORT STATEMENT

```
SORT SFILE ON [ DECENDING
               ASCENDING ] KEY data-name-1 etc.
```

USING IFILE, GIVING IFILE.

AT RUN TIME

```
:FILE DATA,SHR
```

bulletins

SIS/3000 and SAS/3000

Babs Brownyard
HP General Systems

SIS/3000 (HP 32900A.01.00) and SAS/3000 (HP 32901A.01.00) are available now from Software Distribution. Both products have been recompiled under COBOL B and have been verified on HP 3000 Series II.

There were a few problems in SAS/3000 which have been solved:

1. Study hall overlay –
 An error was corrected which caused study halls to overlay assigned course sections in cases where study hall fill-in and semester balancing were both requested.

2. Negative seats —

In cases of section overload being allowed, a negative value for remaining seats was being printed as a positive value on the master schedule. This has been corrected.

3. Period distribution list — 10 day cycle —

Erroneous and/or extraneous data was printed on the period distribution list in the case of a school with a 10-day cycle; a fix has been made for this also.

HP 3000 USERS GROUP MEETING

Doug Mecham
Hughes Aircraft Co.

The 5th International Users Group meeting is about to happen —

September 28 — October 1
Baltimore Hilton
Baltimore, Maryland, USA

If you are interested in hearing about how 190 terminals can be put on the HP 3000, about programs to control and monitor user processes, or about a manufacturing application, then plan to attend. Of course, there will be planned discussions on Data Base Operations, Installation Management, as well as other key topics. There will be panels of HP representatives and users discussing user how-to techniques, user survey results, and new products. Naturally, you will pick up new user ideas and tid bits that will make you more successful. Among the serious technical material will be specially-designed sessions for "attitude adjustment" along with prize drawings for contributors and participants. There will be a time and place for everyone to speak up. For more information and a registration packet write or call:

Mr. Gary Green
Maryland Department of Education
Information Systems
P. O. Box 8717
Baltimore, Maryland 21246
(301) 796-8300, ext. 323

Don't miss picking up important HP 3000 information or miss out on the fun . . .

HIPRI: IF YOU=INTEREST THEN
GO TO BALTIMORE;

HP 3000 USERS GROUP MEMBERSHIP

Doug Meecham
Hughes Aircraft Co.

Useful information is disseminated continuously through our Newsletter and definite action takes place via our

committees. For instance, the Interface Committee receives user input and meets with HP to discuss user's primary concerns regarding the HP 3000 and its support. (Many of the current FORTRAN enhancements and new MPE features were a direct out-growth of these meetings). The Library Committee is currently preparing a tape of user contributions with accompanying documentation and indexes for distribution to site members.

The most active committee at the meetings is the Computer Usage Committee which sponsors "Birds of A Feather" sessions featuring such topics as system performance, statistics, transaction processing, data base techniques, operating system control, and installation management. These themes are discussed in the Newsletter and when users get together to develop associated ideas to help their system operation. Local to most users is a Regional Users Group (RUG) which holds local meetings to communicate user techniques and to interface with their regional HP office.

If you actively use the HP 3000 you should be a member of our Group; there are a number of advantages.

For the individual Membership, the advantage is a subscription to the Newsletter plus special mailings. Example: the May Newsletter contained an index to Communicator Software Tips and the July Newsletter contains a users' guide to FORTRAN enhancements to supplement your old manual. Cost of the individual membership is \$10 per year.

The Site Membership not only receives the Newsletter but also is sent one copy of meeting proceedings, complete membership list with site profiles, special publications, and one magnetic tape copy of the users' contributed library with documentation and index. Cost for the Site Membership is \$100 per year.

For a brochure, how to join information, or for the location of your local RUG contact:

Mr. Gerald Schwartz
Hartford Insurance Group
1 Hartford Plaza
Hartford, Connecticut 06115
(203) 547-3669

Of course you may send your membership fees in today and receive a copy of the May and July Newsletters. Make your check payable to HP 3000 Users Group.

Doug Mecham
Newsletter Chairman

P.S. I will accept all Newsletter articles on the HP 3000 . . . from anybody! Your 2 cents is worth \$\$ to others *and* vice versa.

software updates

Each issue of the **Communicator** provides you with information pertinent to the status of 3000 software products including the latest software changes and enhancements.

The 3000 software updates described in this issue relate to the following products:

PRODUCT	3000 CX	3000 SERIES II	NUMBER	UPDATE AND FIX LEVEL	MIT TAPE DATE CODE
MPE II		X	32002A	00.02	1630
MPE II		X	32002A	00.03	1634
2100 Cross Assembler	X	X	32223A	01.00	1630
2780/3780 Emulator	X		30130B	01.05	1623
BASIC/3000	X	X	32101B	00.02	1630
BASIC/3000		X	32101B	00.03	1634
BASICOMP/3000	X	X	32103B	00.01	1630
COBOL/3000	X	X	32213B	02.01	1630
Compiler Library/3000	X		32211C	04.02	1630
Compiler Library/3000		X	32211D	00.02	1630
DEL/3000		X	32206A	01.00	1634
FCOPY/3000		X	32212A	01.02	1630
Fortran/3000	X	X	32102B	00.03	1630
QUERY/3000		X	32216A	03.01	1634
RPG/3000	X	X	32104A	02.06	1630
RPG/3000		X	32104A	02.07	1634
Scientific Library		X	32205B	00.01	1634
Sort/3000	X	X	32214B	01.01	1630

Where changes in documentation are indicated, updates to the appropriate manuals will be printed. This information is provided simply as a temporary measure.

Note: The 3000 CX software changes described in the July issue of the **Communicator** (date coded 1623) are included in the MIT tape date coded 1630; while the 3000 Series II software changes for Series II MIT date coded 1630 are incorporated in MIT tape date coded 1634.

MPE 32002A.00.02 AND MPE 32002A.00.03

This article describes MPE 32002A.00.02 and MPE 32002A.00.03 as incorporated in to the 3000 Series II MIT tape date coded 1630 and 1634. The information in the article is organized as follows:

1. Modules modified for MPEII A.00.02 and MPEII A.00.03
2. Supported Utility Module changes for MPEII A.00.02 and MPEII A.00.03
3. List of problems solved in MPEII A.00.02 and MPEII A.00.03
4. Known problems in MPEII A.00.03
5. Documentation changes in MPEII A.00.02

1. MODULE CHANGES		A.00.XX		
MODULE		1	2	3
INITIAL	0		X	X
SYSDUMP	1		X	X
SEGPROC	2		X	
SEGDVR	3		X	
DISPATCH	4		X	
LOAD	5		X	
UCOP	7		X	
DEVREC	8			
PROGEN	9		X	X
ININ	10			
MEMLOGP	11		X	
LOG	12			
IOPTRD0	13		X	X
IOPTNP0	14		X	X
IOPLTO	15			
IOMDISC0	16			
IOFDISC0	17			
IOTAPE0	18			
IOLPRT0	19		X	
IOCDRD0	20			
IOTERM0	22		X	X
IOPRPNO	24			
IOREM0	25			
IOMDISC1	27			
PFAIL	30			
FILESYS	50		X	X
COMM'INT	51			X
STORT/RESTORE	52			
DIRC	53			
ALLOCATE	54			
DISCSPC	55			
MMCORE	56			
MMDISKR	57		X	X
ABORTTRAP	58		X	
MESSAGE	59			
CROUTINE	60			
NRIO	62		X	X
PCREATE	63		X	
MORGUE	64			
PROCMAIL	65			
PINT	66		X	
DATASEG	67		X	
CRIO	68		X	X
CHECKER	69			
UTILITY	70			
SEGUTIL	71		X	
LOADER1	72		X	
RINS	73	X		X
JOBTABLE	74			
DEBUG	75			
NURSERY	76			
STKDUMP	77			
FIRMWARESIM	78			

SPOOLING	79			
SPOOLCOMS	80			
MESSAGE CAT	-			

2. SUPPORTED UTILITY MODULE CHANGES FOR MPEII A.00.02 AND MPEII A.00.03				
MODULE		1	2	3
DISKEDT2				
DPAN2			X	X
FREE2				
LISRDIR2				
LISTEQ2				
LISTLOG2			X	X
PATCH2				
MEMLOGAN				
MEMTIME				
SADUTIL				
SLPATCH				

3. PROBLEMS SOLVED IN MPEII A.00.02

- a. The FCONTROL Intrinsic control codes 10 and 11, which change terminal input and output speeds, perform correctly.
- b. On an UPDATE, the DEVICE CLASS table size has been reduced.
- c. INITIAL now accepts DRT#3 as valid.
- d. Previously, the logical flag denoting a zero count in the paper tape punch driver initialized to a FALSE state. This problem, which could cause data to be lost in the punch driver, has been corrected.
- e. The paper tape driver (IOPTPN0) now sets ASCII/BINARY mode as specified.
- f. Error #44 also occurs when you attempt to load a privileged SL segment, unless you have privileged mode (PM) capability.
- g. The count truncation for the line printer driver has been changed to 256 bytes for line printers with more than 132 columns.
- h. A fix has been made to the DISCONNECT process so that a disconnect occurs on primary or secondary carrier failure.
- i. SEGMENTER now only allows DEBUG when a user has privileged mode (PM) capability.
- j. SYSTEM FAILURE #248 no longer exists.

- k. FOPEN now includes device type bounds checks on 600 and 700 type CALCOMP plotters.
- l. MEMLOGGING now allows logging intervals greater than 30 seconds.
- m. The ACTIVATE intrinsic now only uses the last two bits (bits 14 and 15) to activate the suspend (suspend) parameters; ACTIVATE also allows you to change the range check if the process identification number (PIN) is valid.
- n. The CREATE intrinsic now checks to insure maxdata does not exceed the maximum stack size.
- o. SEGMENTER now has a larger stack size.
- c. A File Control Block (FCB) vector is destroyed. This may result in System Failure #50 if the file system catches it or System Failure #102 if the memory manager catches it.
- d. A read of an odd number of bytes modifies the next byte of the user's buffer.
- e. A session with an outstanding READ cannot be aborted until a carriage return is entered.
- f. Intrinsic "BINARY" returns CCE for strings 65536, 65537, 65538, 65539 instead of CCG (OVERFLOW).
- g. In some cases the error message in job mode does not correspond to the error number — the error number is correct.

3. PROBLEMS SOLVED IN MPEII A.00.03

- a. PTAPE bug is corrected. MPE makes a call to TERMINIT to restart terminals after a power-fail.
- b. 2640/2644 now is used in page mode, as well as line block mode, regardless of terminal strapping. (Page and line mode transfer a line at a time.)
- c. Impedance logic is changed in WRITEDSEG to insure that WRITEDSEG will impede before the unimpede when MAMIODONE is issued.
- d. You can delete a CLASS used as an OUTPUT CLASS for DEVICE X and then add this CLASS back into the system tables. SYSDUMP updates CLASS X to denote that it has OUTPUT CLASS originally defined.
- e. DEALLORIN was changed to prevent FREERIN from freeing local rins.
- f. INITIAL gets space for virtual memory with deleted tracks if unable to get large enough space without deleted tracks.
- g. I/O ERROR LOGGING was added to IOPTRDØ.
- h. I/O ERROR LOGGING was added to IOPTPNØ.

4. KNOWN PROBLEMS IN MPEII A.00.03

- a. Memory manager loses a MTAB entry. If enough are lost System Failure #130 will occur.
- b. System Failure #311 ("Abort while critical") occurs when a code segment or memory links are destroyed.

- h. A call to XARITRAP after a call with an illegal PLABEL returns garbage to OLDLABEL.

5. DOCUMENTATION CHANGES TO MPEII A.00.02

- a. CONSOLE OPERATOR'S GUIDE (30000-90013) Page B-6. Delete any references to ERROR #248 in table B-1.
- b. ERROR MESSAGES AND RECOVERY MANUAL (30000-90015) Page 5-3. In table 5-1, replace ERROR #44 MEANING column with "User needs privileged mode capability to add privileged segment or to load a privileged SL segment."
Page 7-19. Delete any references to ERROR #248 in table 7-8.
- c. LINE PRINTER OPERATING AND PROGRAMMING MANUAL (30209-90008) Page A-3 & A-4. Delete any references to MPE using only 132 characters in table A-2 and table A-3.
- d. MPE SEGMENTER REFERENCE MANUAL (30000-90011) Page 4-3. In table 4-1, replace ERROR #44 COMMENT column with "User needs privileged mode capability to add privileged segment or to load a privileged SL segment."

2100 CROSS ASSEMBLER, HP 32223A.01.00

This article describes 2100 Cross Assembler, HP 32223A.01.00 as incorporated in the 3000CX and Series II MIT tape date coded 1630.

PROBLEMS CORRECTED IN 2100 CROSS ASSEMBLER:

The FOPTIONS parameter in SYMFILE was changed to no multi-record. Previously, SYMFILE was opened with buffering multi-record, and a block factor of 12, which was inconsistent and resulted in wasted disc space and the necessity of creating a large symbol table file.

2780/3780 EMULATOR, HP 30130B.01.05

This article describes 2780/3780 Emulator, HP 30130B.01.05 as incorporated in the 3000 CX MIT tape date coded 1623.

PROBLEMS CORRECTED IN 2780/3780 EMULATOR:

1. A space compress error in the 3780 Emulator, that is, spaces were incorrectly compressed for exactly 40 spaces.
2. The driver was modified to drop DATA TERMINAL READY when DATA SET READY drops during a write continue.

BASIC/3000, HP 32101B.00.02

This article describes BASIC/3000, HP 32101B.00.02 as incorporated in the 3000CX and Series II MIT tape date coded 1630.

PROBLEMS CORRECTED IN BASIC/3000:

1. On a PRINT USING statement, a TAB past column 72 did not cause the appropriate number of spaces to be skipped.
2. Execution of the TYP function caused a record to be skipped by a subsequent serial file LINPUT statement.
3. An Integer Overflow resulted from a file READ from an ASCII file in large-stack situations (i.e., extremely large program and/or large data area).
4. The Interpreter infrequently aborted with a Privileged Instruction error due to the execution of the TIM function with a non-negative argument.

OUTSTANDING PROBLEMS IN BASIC/3000:

1. The interpreter aborts with a stack underflow when control-Y is typed in certain circumstances. This occurs most often when printing the **FREQ** table. The problem may also arise in some cases when **INVOKING** or using the **ABORT**, **CALLS** or **FILES** commands in **BREAK-mode**.

Alternative (for **BREAK-mode** commands): Type control-Y and set a breakpoint at the next statement to be executed. Then enter the **GO** or **RESUME**

command. When you break at the next statement, it will then be safe to use any **BREAK-mode** commands.

2. The statement "PRINT #F;END" fails for one-record file.
3. \$NULL is always treated as a binary file. This causes the **ADVANCE** and file **LINPUT** statements to terminate with an error rather than recognize an end-of-file. The **UPDATE** statement also terminates with the wrong-message.
4. The command "RUN ,NOECHO,OUT= . . ." suppresses prompting when the input device is interactive with the list device.
5. The statement "PRINT #F,R" fails to set the end-of-record at the beginning of a **BASIC** formatted file.
6. Lower-case characters are not recognized as format specifications in **PRINT USING** format string expressions.
7. **BASIC** will not permit full utilization of files with variable-length records when the number of logical records (**EOF**) exceeds the maximum number of physical records (**LIMIT**) specified when the file was created. This results in a premature end-of-file condition when reading from or writing to the file, resulting in wasted disc space in the latter case.

Alternative (to permit reading the entire file): If the **:LISTF** command reveals that the **EOF** indicator exceeds the **LIMIT**, use **FCOPY.PUB.SYS** to create a new file with the **EOF** equal to the **LIMIT**:

```
:RUN FCOPY.PUB.SYS
>FROM=oldfilename; TO=newfilename; NEW
>EXIT
:PURGE oldfilename
:RENAME newfilename,oldfilename
```

BASIC/3000, HP 32101B.00.03

This article describes **BASIC/3000**, **HP 32101B.00.03** as incorporated in the 3000 Series II MIT tape date coded 1634.

PROBLEMS CORRECTED IN BASIC/3000:

1. Execution of the **CHAIN** or **INVOKE** statement caused **BASIC** to abort with **Privileged Instruction** error when the main program was very short and the data area (including **COM**) was extremely large.
2. A **RESTORE** statement specifying a non-existent label caused **BASIC** to abort with a **Bounds Violation** error on a subsequent attempt to run the program.

3. Execution of an INVOKE to a program with CALL statements caused BASIC to abort with a Bounds Violation error (or caused a spurious "CAN'T LOAD" BASIC error) on a subsequent attempt to run the program.
4. Abnormal termination of a BASIC program (esp., in batch mode) sometimes caused the Job Control Word to be set to %100000, destroying any value that may have been set in previous job steps. (This would have an effect only if the :BASIC command were preceded by a :CONTINUE command.) The sign bit is now set without altering the other bits.
5. Reads and prints to a file containing variable-length records caused a premature end-of-file error if the record number exceeded the maximum number of physical records ("LIMIT" in a :LISTF) but did not exceed the number of logical records ("EOF" in a :LISTF).
6. Execution of a direct file PRINT with no item list (eg., PRINT #f,r) failed to "clear" the contents of the record in a BASIC formatted data file by setting an end-of-record at the beginning of the record.
7. Execution of a file PRINT ending with the keyword "END" (e.g., PRINT #f;END) failed to set an end-of-file in the last record of a BASIC formatted data file.
8. When using the XEQ command during BREAK mode, a command from the XEQ file which is not permitted in BREAK mode caused a request for permission to abort the BASIC program without waiting for a reply. This condition now generates an error message and the illegal command is ignored.
9. Lower-case characters were not recognized as format specifications in PRINT USING format string expressions.
10. \$NULL was always treated as a binary file, causing the ADVANCE, file LINPUT and UPDATE statements to terminate with an "incorrect file-type" BASIC error. These statements now treat \$NULL as a file of the appropriate type and act accordingly.
11. Specifying both an OUT file and the NOECHO option on the BASIC RUN command (eg., RUN ,NOECHO, OUT=filename) suppressed sending the prompt string effective for the INPUT statement to the input device when that file was interactive with the list file specified (or implied) on the :BASIC command (eg., a terminal).

KNOWN PROBLEMS IN BASIC/3000:

1. The interpreter aborts with a stack underflow when control-Y is typed in certain circumstances. This occurs most often when printing the FREQ table. The problem may also arise in some cases when INVOKing or using the ABORT, CALLS or FILES commands in BREAK-mode.

Alternative (for BREAK-mode commands): Type control-Y and set a breakpoint at the next statement to be executed. Then enter the GO or RESUME command. When you break at the next statement, it will then be safe to use any BREAK-mode commands.

BASICOMP/3000, HP 32103B.00.01

This article describes BASICOMP/3000, HP 32103B.00.01 as incorporated in the 3000CX and Series II MIT tape date coded 1630.

PROBLEMS CORRECTED IN BASICOMP/3000:

1. In very rare circumstances, incorrect code words were passed to a procedure on a CALL statement.
2. File MAT PRINT of a string array to a binary file appeared to "shift" the string information to the left, interspersing "garbage" between the string elements.
3. On a PRINT USING statement, a TAB past column 72 did not cause the appropriate number of spaces to be skipped.
4. Evaluation of some LET statements was incompatible with the BASIC Interpreter. When the destination variable was type-LONG or type-COMPLEX and the expression was a different type, the expression was evaluated at the type of the destination variable, resulting in greater or less precision respectively.
5. Execution of the TYP function caused a record to be skipped by a subsequent serial file LINPUT statement.
6. When the command file record exceeded 80 characters and no USL file was specified on the :BASICOMP command, a spurious failure to open the USL file would abort the compile.
7. The MAT INPUT statement yielded incorrect values for numeric arrays.

OUTSTANDING PROBLEMS IN BASICOMP/3000:

1. When the base is type-REAL and the power is a type-LONG constant representable as an integer (eg., $9^{**}(-2L\emptyset)$), single-precision rather than double-precision arithmetic is performed.
Alternative: replace type-LONG constant power with a variable.
2. The unary-minus operator preceding a constant is not always handled correctly. This causes the following two incorrect results (where "x" represents a constant and "y" represents any variable, constant or expression):
 - a. "-x MOD y" is evaluated as "(-x) MOD y" instead of "-(x MOD y)"

- b. `"-x**y"` is evaluated as `"(-x)**y"` instead of `"-(x**y)"`.

Alternative: Fully parenthesize expression.

3. Incorrect code is generated for I/O FOR-loops with a constant negative one STEP size.

Alternative: Replace the constant STEP size with a variable.

4. \$NULL is always treated as a binary file. This causes the ADVANCE and file LINPUT statements to terminate with an error rather than recognizing an end-of-file. The UPDATE statement also terminates with the wrong message.
5. Incorrect code is generated for a FOR-loop which encloses both an ONEND statement with a destination within the loop and a GOTO statement with a destination outside the loop. This situation will cause spurious run-time aborts if an end-of-file is detected while inside the FOR-loop.

Alternative: Place a superfluous GOTO statement outside the FOR-loop with a destination inside the loop. The GOTO statement itself is not intended to be executed.

6. Lower-case characters are not recognized as format specifications in PRINT USING format string expressions.
7. BASIC will not permit full utilization of files with variable-length records when the number of logical records (EOF) exceeds the maximum number of physical records (LIMIT) specified when the file was created. This results in a premature end-of-file condition when reading from or writing to the file, resulting in wasted disc space in the latter case.

Alternative (to permit reading the entire file): If the :LISTF command reveals that the EOF indicator exceeds the LIMIT, use FCOPY.PUB.SYS to create a new file with the EOF equal to the LIMIT:

```
:RUN FCOPY.PUB.SYS
>FROM=oldfilename; TO=newfilename; NEW
>EXIT
:PURGE oldfilename
:RENAME newfilename,oldfilename
```

8. A bounds violation or other anomalous results occur when a user-defined function is used within a subscript expression on the left-hand side of a LET statement. For example:

```
X(FNA(Y))=10
```

Alternative: Eliminate the reference to the user-defined function in the subscript expression by evaluating it in a preceding statement. For Example:

```
Z=FNA(Y)
X(Z)=10
```

COBOL/3000, HP 32213B.02.01

This article describes COBOL/3000, HP 32213B.02.01 as incorporated in the 3000CX and Series II MIT tape date coded 1630.

PROBLEMS CORRECTED IN COBOL/3000:

- Using the same paragraph name in more than one section sometimes produced erroneous program flow in PERFORM and GO TO statements.
- Compound IF statements combining ANDs and ORs sometimes produced erroneous results and bounds violations in subprograms.
- Programs with very small Procedure Divisions sometimes aborted during compilation with an end-of-file on the COBTEMP file.
- Compiling a subprogram with an empty Working-Storage Section into an existing USL file caused garbage to be written to the USL file and produced a USL file overflow error.
- Attempt to compile a code segment greater than 32K words produced the wrong error message. (Note: 16K words is the largest code segment allowed).
- The compiler did not always detect a run-time stack greater than 64K bytes.
- Moving a signed numeric field to an alphanumeric field moved the sign also. Now, the absolute value will be moved.
- The compiler did not detect an attempt to move more than 32K bytes in a single move.
- Using bounds checking with a SEARCH statement sometimes caused the compiler to abort.
- An elementary item declaration immediately followed by another elementary item declaration with a higher level number (ie., 05 followed by 10) caused the compiler to loop.
- ACTUAL KEY values could only be positive.
- The compiler did not detect an illegal continuation of a literal string.
- The compiler did not detect illegal repetition factors in PICTURE clauses, such as PIC S(5).
- The compiler did not allow +, -, CR, or DB to be used at the end of a PICTURE clause which consisted entirely of zero suppression characters, such as ZZZZ-.

CHANGES MADE IN THE COMPILER LIBRARY FOR COBOL, HP 32211C.04.01:

- A move to an unsigned COMP-3 field now produces a sign of HEX F instead of HEX 0.



- Blanks and overpunching in numeric display items are now allowed. Zone punches in positions other than the least significant position will be ignored.

OUTSTANDING PROBLEMS IN COBOL/3000:

A GO TO statement to the first paragraph in a subprogram may result in a BOUNDS VIOLATION at object time. To get around it, add a dummy first paragraph or section.

COMPILER LIBRARY/3000, HP 32211C.04.02

This article describes Compiler Library/3000, HP 32211C.04.02 as incorporated in the 3000CX MIT tape date coded 1630. (This version of the Compiler Library only supports three word long floating-point operations.)

PROBLEMS CORRECTED IN COMPILER LIBRARY/3000:

- The procedure MPYD now uses the firmware decimal multiply instruction.
- The double Integer multiply and divide routines DMPY and DDIV now use the appropriate firmware instruction.
- Invalid characters in numeric data were not caught if leading zeroes were present. For example, reading "000A" in I4 format would result in a value of zero and no error being reported.
- The operation of the T (tabulate) edit operator in the FORTRAN formatter did not work as one would expect. When it tabbed forward, it blanked the spaces skipped. This could be a problem on a read which later tabbed back to read the data skipped. This has been changed such that the spaces skipped are not blanked. This is changed for both reads and writes. The output buffer will automatically be blanked before a write is initiated.
- The MOVE CHARACTER SUPPRESS operator of the RPG utility function R'EDIT caused a bounds violation on a move of 2 or more characters.

COMPILER LIBRARY/3000, HP 32211D.00.02

This article describes Compiler Library/3000, HP 32211D.00.02 as incorporated in the 3000 Series II MIT tape date coded 1630. (This version of the Compiler Library only supports four word long floating-point operations.)

PROBLEMS CORRECTED IN COMPILER LIBRARY/3000:

- The procedure MPYD now uses the firmware decimal multiply instruction.
- The double Integer multiply and divide routines DMPY and DDIV now use the appropriate firmware instruction.

- Invalid characters in numeric data were not caught by procedure EXTIN if leading zeroes were present. For example, reading "000A" in I4 format would result in a value of zero and no error being reported.
- The operation of the T (tabulate) edit operator in the FORTRAN formatter did not work as one would expect. When it tabbed forward, it blanked the spaces skipped. This could be a problem on a read which later tabbed back to read the data skipped. This has been changed such that the spaces skipped are not blanked. This is changed for both reads and writes. The output buffer will automatically be blanked before a write is initiated.
- The MOVE CHARACTER SUPPRESS operator of the RPG utility function R'EDIT caused a bounds violation on a move of 2 or more characters.

DEL/3000, HP 32206A.01.00

This article describes DEL/3000, HP 32206.01.00, as incorporated in the 3000 Series II MIT tape date coded 1634.

PROBLEMS CORRECTED IN DEL/3000:

- The bounds violation in FORMAINTE edit specification processor has been fixed.
- Form files may now be renamed or moved to any group or account.

ENHANCEMENTS TO DEL/3000:

- READTERM has been changed to recognize the function keys F1 through F8. READTERM will now return a negative status code corresponding to the function key (i.e., F1 = -1, F8 = -8).

FCOPY/3000, HP 32212A.01.02

This article describes FCOPY/3000, HP 32212A.01.02, as incorporated in the 3000 Series II MIT tape date coded 1630.

ENHANCEMENTS TO FCOPY/3000:

- FCOPY supports the HP 2644A terminal.
 - The cartridge drives are addressed as \$CTUL and \$CTUR for the left and right drives respectively.
 - A hard copy printer connected to the terminal is addressed as \$HARD.
 - These designations are appropriate when referring to the FROM=filename and TO=filename as needed.
 - These designations are appropriate only within FCOPY and are invalid elsewhere.

- The program handles \$CTUR and \$CTUL as if they were magnetic tapes.
- Record sizes are limited to 256 bytes — A hard maximum imposed by the hardware.
- The record type of the \$CTUR(L) is derived from the way it is used with the FROM or TO file in a given operation; except, when both files are \$CTU then the record types are binary. For example:

FROM=ANASCII; TO=\$CTUR . . . (\$CTUR is ASCII)
FROM=\$CTUR; TO=ABINARY . . . (\$CTUR is binary)

- To dump the contents of a binary file contained on cartridge to a line printer, the records should be binary; i.e., :FILE LP;DEV=LP;REC=66,1, F,BINARY.
2. The SKIPEOF option has been corrected by testing the fromfile count and fromfile class.

FORTRAN/3000, HP 32102B.00.03

This article describes FORTRAN/3000, HP 32102B.00.03, as incorporated in the 3000CX and Series II MIT tape date coded 1630.

PROBLEMS CORRECTED IN FORTRAN/3000:

1. Use of \$CONTROL LOCATION with interactive TEXT and LIST files will cause a rather odd source listing. This will be disallowed and a warning message will appear.
2. If a secondary entry point for a subroutine is called within that subroutine before it is defined (by an entry statement) the compiler will abort.
3. The global warning count was sometimes incorrect if the nolist compiler control option was selected.
4. A warning, "EXPECTED COMMA", appeared in certain cases where the \$CONTROL CROSSREF option was taken without the "ALL" suboption.
5. Due to a symbol table problem, the name of the compiler library routine AMINO' was sometimes wiped out. When the SEGMENTER attempted to resolve this name, strangely named routines were referenced.
6. The cross referencing of labels was sometimes incorrect.
7. The value pointed to by the trap handling mechanism as the result space for an integer divide by zero trap was the remainder, not the quotient.

QUERY/3000, HP 32216A.03.01

This article describes QUERY/3000, HP 32216A.03.01, as incorporated in the 3000 Series II MIT tape date coded 1634.

PROBLEMS CORRECTED IN QUERY/3000:

1. Non-printing control characters in REPORTs were, in many cases, changed to blanks before being output. They are now printed as is, so that they can be used for their normal control functions.
2. QUERY did not automatically detect whether it was running with the 3-word or the 4-word floating point compiler library. It now does, so that it will now correctly determine which data types it can support in any particular running environment.

RPG/3000, HP 32104.02.06

This article describes RPG/3000, HP 32104.02.06, as incorporated in the 3000CX and Series II MIT tape date coded 1630.

PROBLEMS CORRECTED IN RPG/3000:

1. RSAM processing between limits did not work properly.
2. XFOOT did not properly set resulting indicators.
3. Space after followed by a space before did not work properly.
4. Temporary files created by RPG are now job temporary instead of job step temporary.

RPG/3000, HP 32104.02.07

This article describes RPG/3000, HP 32104.02.07, as incorporated in the 3000 Series II MIT tape date coded 1634.

PROBLEMS CORRECTED IN RPG/3000:

1. An illegal patch occasionally occurred when fetch overflow was used on output specifications.
2. An undefined external of (l'nnnn) occasionally occurred when input generated code extended over two segments.
3. A bounds violation at run time occasionally occurred when input generated code extended over two segments.
4. An invalid error message was given when a move of UDATE was made to an array.
5. A uswitch initialization in batch mode gave an invalid error when variable length input was used, or when data went to the end of a line.

SCIENTIFIC LIBRARY/3000, HP 32205B.00.01

This article describes Scientific Library/3000, HP 32205B.00.01, as incorporated in the 3000 Series II MIT tape date coded 1634.

**PROBLEMS CORRECTED IN SCIENTIFIC LIBRARY/
3000:**

1. One of the constants for the double precision ERROR FUNCTION was incorrect.
2. One of the constants for the double precision LOG of the GAMMA FUNCTION was incorrect.
3. The polynomial function used for the double precision GAMMA FUNCTION was only precise to thirteen decimal digits: This has been replaced with another function which is precise to more than sixteen decimal digits.

SORT/3000, HP 32214B.01.01

This article describes SORT/3000, HP 32214B.01.01, as incorporated in the 3000CX and Series II MIT tape date coded 1630.

PROBLEMS CORRECTED IN SORT/3000:

1. A program calling SORTINITIAL with NUMRECS parameter less than the current end-of-file for a disc file caused an abort. SORTINITIAL now ignores the NUMRECS parameter for disc files and uses the current EOF instead.
2. Using SORT/MERGE with empty disc input files caused the scratch file (SORT) or output file (MERGE) to be opened based on the default file size of 10,000 records. This caused an abort if insufficient disc space was available.

documentation

The following tables list currently available customer manuals for HP 3000 products. This list supersedes the list in the last issue of the **Communicator**.

The most recent changes to the tables are indicated for easy reference. Prices are subject to change without notice.

Copies of manuals and updates can be obtained from your local Sales and Service office. The address and telephone number of the office nearest to you are listed in the back of all customer manuals.

Update packages are free of charge. If you require an update package only, send your request to:

Software/Publications Distribution
5303 Stevens Creek Blvd.
Santa Clara, Ca. 95050

Customers in the U.S. may also order directly by mail. Simply list the name and part number of the manual(s) you need on the Corporate Parts Center form supplied at the back of the **Communicator**.

A few words about documentation terms:

- | | |
|---------|---|
| New | A new manual refers only to the first printing of a manual. When first printed, a manual is assigned a part number. |
| Revised | A revised manual is a printing of an existing manual which incorporates new and/or changed information in its contents. For example, a manual is revised when an update package is incorporated into the manual: the manual gets a new print date and the update package disappears. Note that a revision to a manual effectively obsoletes the previous version of the manual. |
| Update | An update package is a supplement to an existing manual which contains new and/or changed information. Updates are issued when information must get to customers, yet it is inappropriate to issue a revised manual. An update has no part number, it is automatically included when you order the manual with which it is associated. |

MPE/3000 MANUALS

PART NUMBER	3000 CX	SERIES II	MANUAL TITLE	PRICE	PUBLICATION DATE	CURRENT UPDATE
30000-90013		X	Console Operator's Guide	\$ 7.00	6/76	
32000-90004	X		Console Operator's Guide, 32000C MPE/30000	7.00	1/75	10/75
30000-90015		X	Error Messages and Recovery Manual	17.00	6/76	
30000-90008		X	General Information Manual, HP 3000 Series II	6.50	6/76	
03000-90096	X		General Information Manual, Multiprogramming Executive	4.00	11/73	
30000-90046		X	HP 3000 CX to HP 3000 Series II Program Conversion Guide	4.00	6/76	
30000-90045		X	Index to MPE Reference Documents	5.50	6/76	
32000-90002	X		MPE/3000 Reference Manual, 32000C	19.50	1/75	6/76
30000-90009		X	MPE Commands Reference Manual	12.50	6/76	
30000-90010		X	MPE Intrinsic Reference Manual	15.00	6/76	
30000-90011		X	MPE Segmenter Reference Manual	4.00	6/76	
30000-90012		X	MPE Debug/Stack Dump Reference Manual	7.50	9/76 *R	9/76
30000-90044		X	MPE System Utilities Reference Manual	5.00	6/76	
32000-90008	X		MPE/3000 Operating System, System Utilities Manual	3.00	10/75	
30000-90049		X	Software Pocket Guide	3.50	6/76	
03000-90126	X		Software Pocket Guide, HP 3000	3.50	7/75	
30000-90014		X	System Manager/System Supervisor Manual	10.00	6/76	
32000-90006	X		System Manager/System Supervisor Manual, 32000C MPE/3000	13.00	10/75	
03000-90121	X	X	Using the HP 3000: A Guide for the Terminal User	7.50	6/75	

*R = Revised Manual

about the HP 3000

LANGUAGE MANUALS

PART NUMBER	3000 CX	SERIES II	MANUAL TITLE	PRICE	PUBLICATION DATE	CURRENT UPDATE
30000-90026		X	BASIC Interpreter Reference Manual	\$11.50	6/76	
03000-90008	X		BASIC/3000 Interpreter Reference Manual	10.00	7/75	
03000-90050	X		BASIC/3000 Interpreter Pocket Guide	2.50	9/74	
32103-90001	X	X	BASIC/3000 Compiler Reference Manual	3.50	11/74	7/76
03000-90025	X	X	BASIC for Beginners	5.50	11/72	
32213-90001	X	X	COBOL/3000 Reference Manual	12.50	7/75	7/76
03000-90047	X	X	Cross Assembler for 2100 Computers Reference and Application Manual	12.00	5/76	
30000-90040		X	FORTRAN Reference Manual	9.50	6/76	3/76
32102-90001	X		FORTRAN/3000 Reference Manual	13.50	3/76	
32104-90001	X	X	RPG/3000 Compiler Reference and Application Manual	16.50	2/75	
32104-90003	X	X	RPG Listing Analyzer	0.50	4/75	
03000-90002	X		SPL/3000 Reference Manual	7.50	11/73	
03000-90003	X		SPL/3000 Textbook	13.00	11/73	3/75
30000-90024		X	System Programming Language Reference Manual	15.00	9/76 *R	7/76
30000-90025		X	System Programming Language Textbook	11.00	6/76	9/76

*R = Revised Manual

† There are instances where a new edition of the manual and an update are both shown with the same date. The new edition incorporates all changes made in the update. If you already have the manual, order the update only; otherwise order the new edition.

†† This manual update package incorporates HP 3000 Series II manual references and software changes.

about the HP 3000

ADDITIONAL MANUALS

PART NUMBER	3000 CX	SERIES II	MANUAL TITLE	PRICE	PUBLICATION DATE	CURRENT UPDATE
30000-90047		X	2780/3780 Emulator Reference Manual	\$ 8.50	6/76	
30130-90001	X		2780/3780 Emulator Subsystem Reference and Application Manual	10.00	12/74	2/76
30000-90028		X	Compiler Library Reference Manual	12.00	6/76	
03000-90009	X		Compiler Library Reference Manual, HP 3000	10.00	2/76	
30000-90050		X	Data Entry Library Manual	6.50	6/76	
03000-90012	X	X	EDIT/3000 Reference Manual	7.50	8/75	6/76
03000-90064	X	X	FCOPY Reference Manual	6.00	6/76	
30119-90009	X	X	HP 2894A Card Reader Punch Operating and Programming Manual	7.00	6/76	
03000-90107	X	X	HP 3000 Cross Loader for HP 2100 Computer	11.00	10/74	6/76
36995-90013	X		IBM 1130/1800 to HP 3000 FORTRAN Conversion Guide	6.00	2/75	5/75
32104-90004	X		IBM System/3 to HP 3000 Conversion Guide	7.50	12/75	
30000-90041		X	IMAGE Data Base Management System Reference Manual	4.50	6/76	
32215-90001	X		IMAGE/3000 Reference Manual	7.00	3/76	
30000-90057		X	Instruction Decoding Pocket Guide	1.00	6/76	
30209-90008		X	Line Printer Operating and Programming Reference Manual	6.00	6/76	
30000-90022		X	Machine Instruction Set Reference Manual	7.00	6/76	
30000-90066		X	Programmable Controller Reference and Application Manual	6.00	6/76	
30300-90002	X		Programmable Controller Reference and Application Manual	12.00	2/75	4/76
30000-90042		X	QUERY Reference Manual	6.50	6/76	
32216-90001	X		QUERY/3000 Reference Manual	7.00	3/76	
30000-90067		X	Real-Time Programmable Controller Reference and Application Manual	7.50	6/76	
30301-90002			Real-Time Programmable Controller Reference and Application Manual	9.50	2/75	
30000-90027		X	Scientific Library Reference Manual	5.00	6/76	
03000-90010	X		Scientific Library Reference Manual, HP 3000	7.00	7/75	
30000-90016		X	Site Preparation Manual	6.00	6/76	
30000-90017		X	Site Planning Workbook, HP Computer System	10.00	6/76	
32214-90001	X	X	Sort/3000 Reference Manual	6.50	6/76	
32901-90001	X	X	Student Assignment System Reference Manual	10.00	7/75	8/76
32901-90005	X	X	Student Assignment System – Technical Manual	13.00	7/75	
32900-90001	X	X	Student Information System Reference Manual	18.00	9/74	8/76
32900-90002	X	X	Student Information System – System Overview	7.00	9/74	
32900-90005	X	X	Student Information System – Technical Manual	18.50	3/75	
30000-90020		X	Systems Reference Manual	9.50	6/76	
03000-90019	X		Systems Reference Manual, HP 3000 Computer	14.00	9/73	
03000-90015	X	X	Trace/3000 Reference Manual	4.00	6/76	

*R = Revised Manual

†† This manual update package incorporates HP 3000 Series II manual references and software changes.

training schedule

The schedule for customer training courses on General Systems Division products is outlined below, and in the 2000 Access section of this publication. Included here are HP 3000 software courses offered in the U.S. and in Europe for the period September through December, 1976. You can also obtain a copy of the schedule from your local HP sales office. A European course schedule is available through the sales offices in Europe; a U.S. schedule through U.S. sales offices.

Registration

Requests for enrollment in any of the courses should be made through your local HP Sales Office. Your Sales Representative will supply the Training Registrar at the appropriate location with the course number, dates, and requested motel reservations. Enrollments are acknowledged by a written confirmation indicating the training course, time of class, location and accommodations reserved.

GENERAL SYSTEMS DIVISION COURSE SCHEDULE (U.S.)

September - December 1976

Course Dates and Training Center Location

NUMBER	COURSE TITLE	LENGTH	PRICE	GENERAL SYSTEMS SANTA CLARA	EASTERN TRAINING CENTER - ROCKVILLE
22801A	3000 Series II, A Comprehensive Introduction	5 days	\$500	9/27/76 10/11/76 11/1/76 11/29/76	9/20/76 11/1/76 12/13/76
22802A	3000 Series II, System Management and Operation	4 days	400	9/7/76 10/4/76 10/18/76 11/8/76 12/6/76	9/27/76 11/8/76 12/20/76
22803A	3000 Series II, Advanced Usage	5 days	500	10/18/76	10/25/76 11/29/76
22804A	3000 Series II, SPL (Systems Programming Language)	5 days	500	10/25/76	11/1/76 12/6/76
22956A	3000 IMAGE	5 days	500	9/13/76 10/11/76 10/25/76 11/15/76 12/13/76	10/4/76 11/15/76
22957A	3000 COBOL, Audio Self Study	30 hrs.	325	These courses can be ordered using the Direct Mail Order form in the back of the Communicator.	
22958A	3000 BASIC, Audio Self Study	30 hrs.	325		
22975A	System 3 Conversion Seminar	2 days	200	11/22/76	

about the HP 3000

about the HP 3000

Accommodations

Students provide their own transportation, meals, and lodging. The Training Registrar will be pleased to assist in securing motel reservations at the time your Sales Office requests a registration.

Cancellations

In the event you are unable to attend a class for which you are registered, please notify the Training Center Registrar immediately in order that we may offer your seat to another student. To avoid paying for a reservation which you do not use, we must receive notification of your cancellation no later than two weeks before the class begins.

GENERAL SYSTEMS DIVISION COURSE SCHEDULE (EUROPE)

September - December 1976

COURSE NUMBER	COURSE TITLE	LENGTH	FRANKFURT (GERMAN)	WINNERISH (ENGLISH)	ORSAY (FRENCH)	MILAN (ITALIAN)	STOCKHOLM (ENGLISH)
22801A	3000 Series II, A Comprehensive Introduction	5 days	9/6 11/8		10/18	10/25	10/11 11/8 12/6
22802A	3000 Series II, System Management and Operation	4 days	9/20 11/22		10/25	11/8	9/6 10/18 11/15 12/13
22803A	3000 Series II, Advanced Usage	5 days					11/22
22804A	3000 Series II, SPL (System Programming Language)	5 days					9/20
22956A	3000 IMAGE	5 days	10/4 12/6		11/15	12/13	9/13 10/25
22963A	3000 Scientific/Engineering User	5 days		10/18			

Training Center Addresses

UNITED STATES

Rockville 4 Choke Cherry Road Rockville, Maryland 20850 (301) 948-6370	Santa Clara 5303 Stevens Creek Blvd. Santa Clara, California 95050 (408) 249-7020
---	--

EUROPE		
Winnersh King Street Lane Winnersh, Wokingham Berks RG11 5 AR Tel: Wokingham 784774 Cable: Hewpie London Tele: 847178 9	Orsay Quartier de Courtaboeuf Boite postale No. 6 F-91401-Orsay France Tel: (1) 907 78 25 Cable: HEWPACK Orsay Telex: 60048	Frankfurt Vertriebzentrale Frankfurt Berner Strasse 117 Postale 560 140 D-6000 Frankfurt 56 Tel: 0611 5004 Telex: (841) 04-13249, 04-13081 Cable: HEWPACKSA Frankfurt
Milan Via Amerigo Vespucci, 2 1-20124 Milan Tel: (2) 62 51 Cable: HEWPACKIT Milano Telex: 32046	Stockholm Enighetsvagen 1-3, Fack S-162 20 Bromma 20 Tel: (08) 730 05 50 Cable: MEASUREMENTS Stockholm Telex: 10721	

featuring — new software enhancements for HP 2000



Hewlett-Packard is announcing new software capabilities for the HP 2000 Computer System. These capabilities include:

- Enhancements to the 2000 Operating System (22687A).
- A new data entry package designed for the HP 2640 Series display terminals.

ENHANCEMENTS TO THE 2000 OPERATING SYSTEM

Significant enhancements added to the 2000 Operating System in the areas of BASIC language facilities, reliability and communications are:

- 2000 to 2000 Communications
- Page Mode Support for HP 2640 Terminals
- Support for Card Reader Punch Interpreter
- Elimination of System Paper Tape Reader for loading System on 21MX Systems
- WARMSTART to improve System Reliability
- LOAD Command allows BASIC Programs to be loaded from ASCII Files
- Formatted Output to ASCII Files, e.g. Line Printers
- Program Detection of "BREAK" and Errors

These enhancements are being distributed under revision code 1628. The installation of revision 1628 is mandatory and is performed by your Hewlett-Packard Customer Engineer at no cost to you under the provisions of your HP warranty or service contract. On-going maintenance support for revision 1628 also is provided under the provisions of your warranty or service contract. Support for the current revision 1620 will be phased-out by October 31, 1976.

2000 TO 2000 DATA COMMUNICATIONS

Communication between two 2000 Systems uses the same communication protocol found within the IBM HASP MRJE facilities available with each 2000 operating system. In many ways the technique of communicating is very similar to the process of RJE except that only data, not jobs, can be transmitted between 2000 Systems. This capability is inherent in any system using Revision 1628 software. Reloading the communication processor is not necessary to switch from a 2000 communicating to an IBM or another 2000 System.

As a result, this new capability can provide the following potential benefits:

- Allows synchronization of data bases stored on 2000 systems distributed throughout a multidivisional computing network.
- Saves data communication costs, allows storing and forwarding bulk data at high speed at most economical times to another 2000 system.
- Permits transfer of important files to other 2000 systems to be used as back-up facilities.

The typical data communication hardware required to link two systems together is shown in figure 1.

Each system can accommodate one synchronous interface (HP 12618A) operating at speeds up to 4800 bps. (For further reference, refer to the *HP 2000 Operator's Manual* (22687-90005) on page 6-22.)

Transmitting Data Between 2000 Systems Using Physical Devices

Data entered into System A's card readers, paper tape readers or card reader/punch can be transmitted to System B under program control by equating those devices to any one of seven host reader functions (HR1-7) (see figure 2). This data will immediately be listed on System B at any one of up to seven host lister functions (HL1-7). Concurrently, messages typed into the system A's console host inquiry function (HI) can be immediately printed at System B's console using its host message function (HM) and vice-versa.

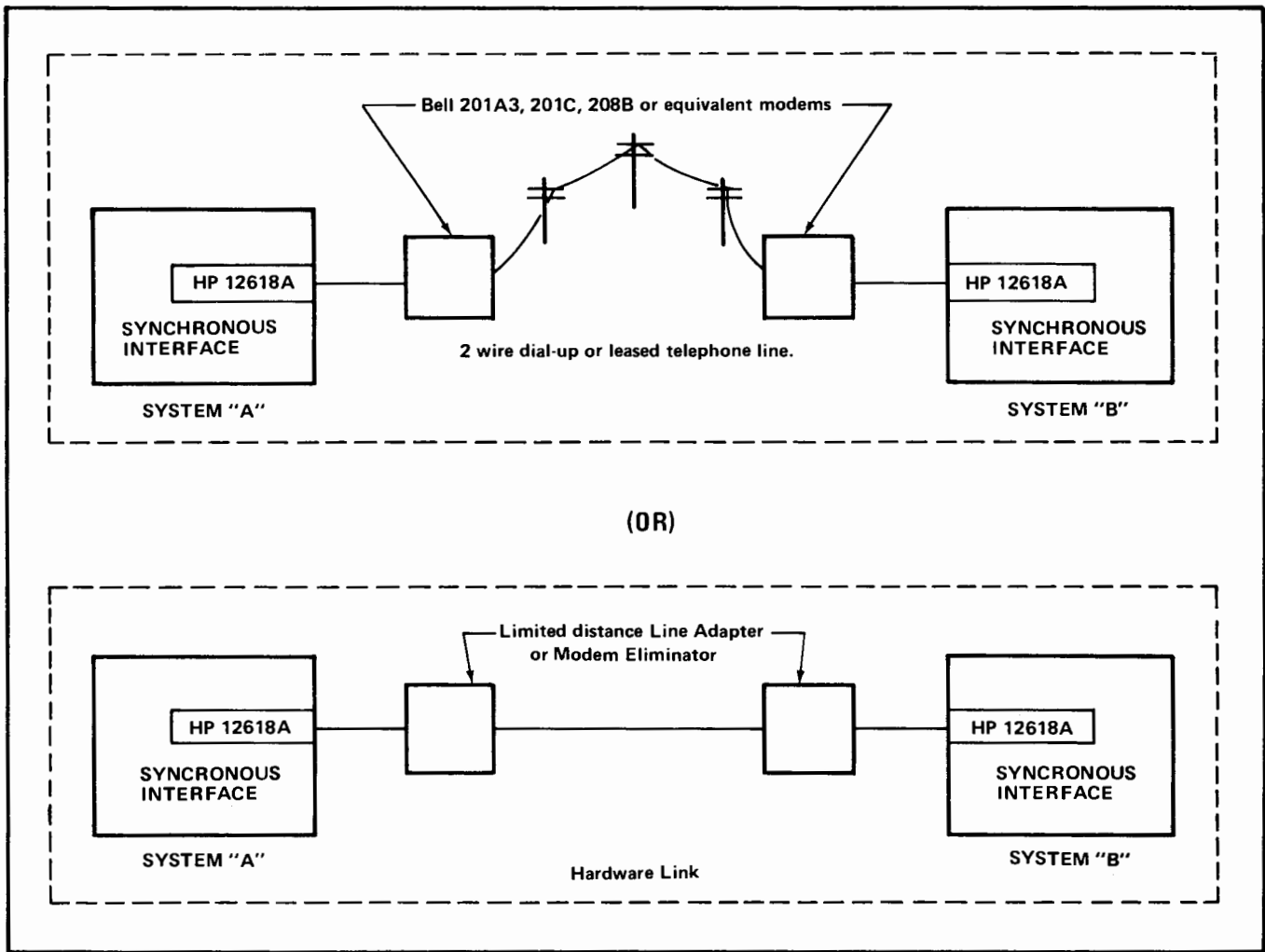

Figure 1. Data Communication Link

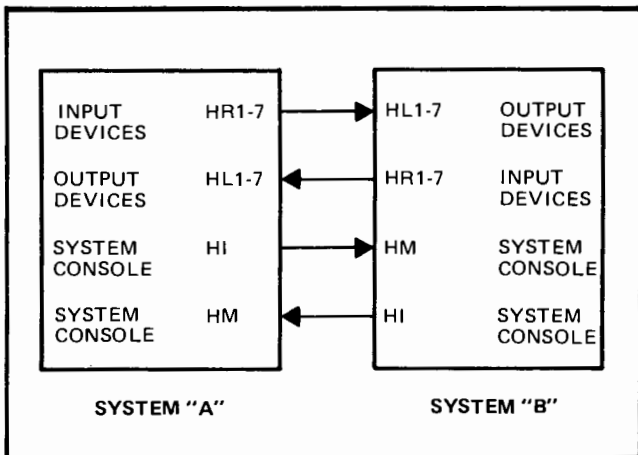

Figure 2. Transmitting Through Functions

Transmitting Data Between Programs

A key feature of 2000-2000 communications is its ability to be used to transmit data from a BASIC program executing on System A to a BASIC program executing on System B, and vice-versa, as shown in figure 3. Each program utilizes the systems job transmitters (JT0-6) and job lister (JL0-6) functions to provide a path to exchange data between programs. JT0 is automatically linked to JL0, etc. Of course, while this exchange is taking place, each 2000 System can support other users and applications. Also, more than one BASIC program on one system may concurrently transmit data to more than one program on another system.

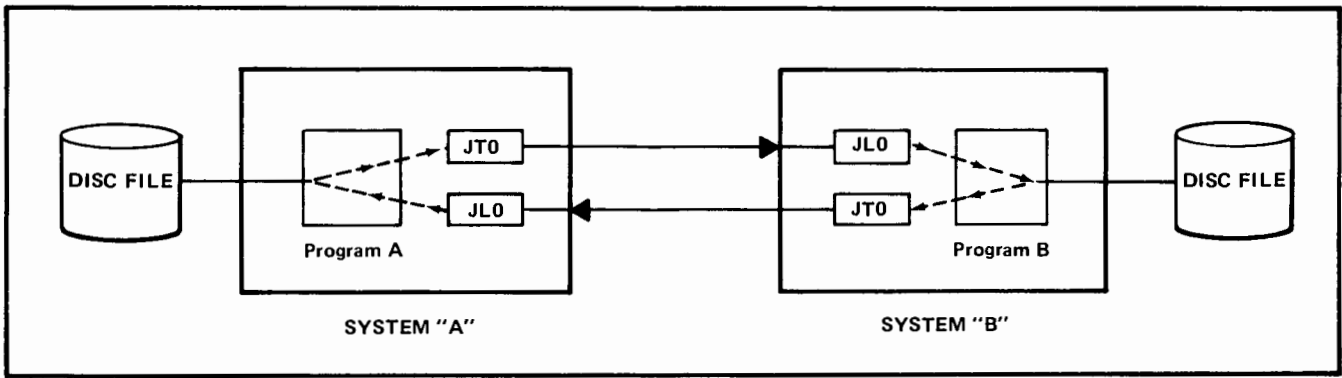
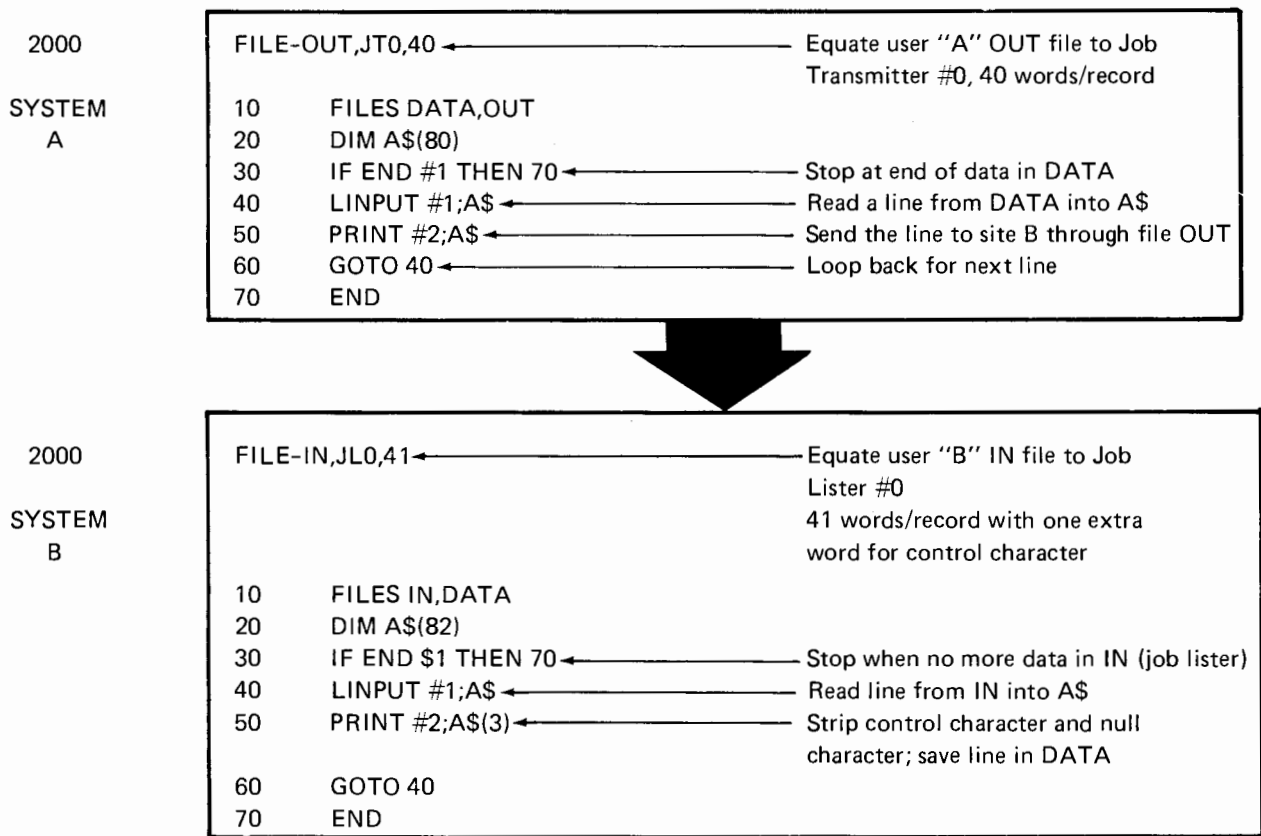

Figure 3. Transmitting Data Thru Job Transmitters/Listers

Typical Link-up for transferring data between programs. Data is stored in disc files. (See next section for example of BASIC programs which transmits data from System A to B.)

EASY TO USE

The following diagram illustrates how easy it is to write a BASIC program to transfer data from a disc file named DATA containing 80 characters/record from System A to a disc file named DATA on System B.



EXPANDED TERMINAL SUPPORT:
HP 2640 PAGE MODE OPERATION

A terminal type parameter is required when logging-in with the HELLO command. This parameter tells the system what type of terminal you are using and used to modify the transmission of data to your terminal.

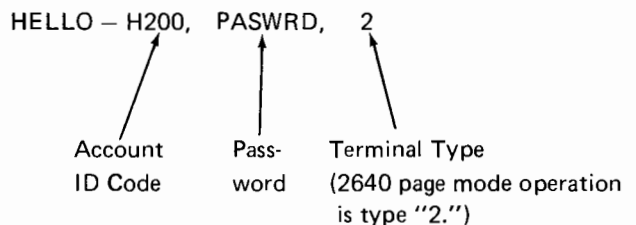

A list of terminal types with commonly used terminals associated with each type is provided below. (Note that the HP 2640 and 2644 display terminals may now operate in page mode on the HP 2000 under terminal type number 2.)

TERMINAL TYPE	TYPICAL TERMINALS
0	HP 2749A, ASR 33, ASR 38 teleprinters
1	HP 2640A, HP 2644A
2	HP 2640A, HP 2644A in page mode
3	HP 2600A CRT terminal
4	HP 2762A/B, GE TermiNet 300, GE TermiNet 1200
5	ASR 37
6	GE TermiNet 30
7	Texas Instruments Silent 700
8	Execuport 300

(For more detailed information refer to Appendix D of the HP 2000 BASIC Reference Manual (22687-90001).

CARD READER PUNCH SUPPORTED

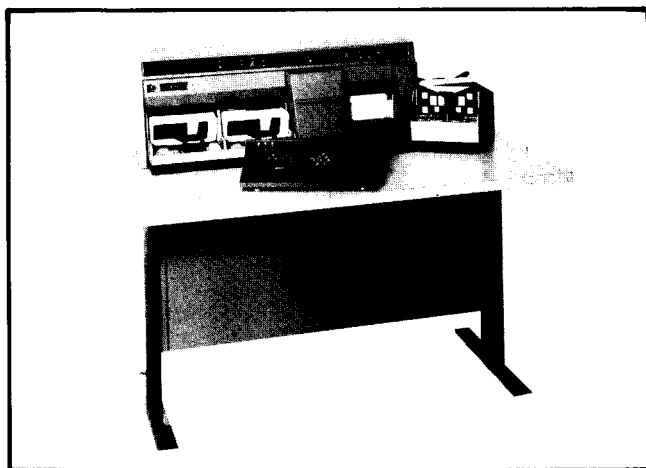

The card reader punch subsystem (HP 12989A) is supported as a new ASCII file device on the 2000 Computer System. BASIC programs can read or write to this device, and up to 7 devices can be physically attached to the communication processor. The following features are supported:

- 80 column card reading, punching and printing.
- Reading rate is 100 CPM
- Punch/print rate is 45 to 75 CPM
- I/O punched code is in Hollerith format.

- Can be used as direct input device to IBM and CDC RJE function and 2000 to 2000 communications.
- Can be used as IBM HASP RJE output punch device.

(For further reference, refer to pages 11-33 and 11-35 of the HP 2000 BASIC Reference Manual (22687-90001).)

PAPER TAPE READER NOT REQUIRED ON 21MX BASED SYSTEMS

Revision 1628 eliminates the need for the paper tape reader on 21MX-based system to load the system master tape. A mag tape bootstrap ROM (12992D) will be installed on your system at no charge to perform this function.

However, the paper tape reader is still required on 2100-based systems for this function. The reader is now attached to the communication processor and a new cross-loader program is being provided to support 2100-based systems.

In either case, the paper tape reader can be used as a non-sharable ASCII device on the communication processor.

Because of the repositioning of the paper tape reader, your communication processor may need more memory or an I/O extender. Your HP customer engineer will help you determine whether you need this additional hardware.

More than likely, your system will not require additional hardware, and the installation of Revision 1628 will proceed in a normal fashion under the provisions of your service contract. However, if you have any questions, please contact your local HP Customer Engineer.

WARMSTART

System recovery procedures have been improved in Revision 1628 software with a new WARMSTART PROGRAM. Previously system recovery from software crashes, CPU errors and complete disc failures required reloading from SLEEP and HIBERNATE tapes.

Now, with IB and the WARMSTART PROGRAM, the contents of certain memory resident tables are maintained concurrently on disc. This provides a means for the WARMSTART PROGRAM to recover system operation after a failure without a mag tape reload in most cases. (Refer to Appendix G-6 of the HP 2000 Operators Manual (22687-90005).)

LOADING PROGRAMS FROM ASCII DEVICES

The new LOAD command loads the contents of an ASCII file – from any input device or disc – into the user’s work space on the 2000 System. If the ASCII file contains the images of a BASIC program, the file is converted to a valid

program that may be executed by a RUN command on the system. Also, after executing the LOAD command, the contents of the workspace may be permanently saved on the system by executing a SAVE or CSAVE command.

Example

The following dialogue creates an ASCII file, **CARDER**, which is assigned to the card reader, **CR0**; **SCR** clears the user work area, and the **LOAD** command reads the program source images from the card reader into the user work area.

```
FILE - CARDER, CR0
SCR
LOAD - CARDER
```

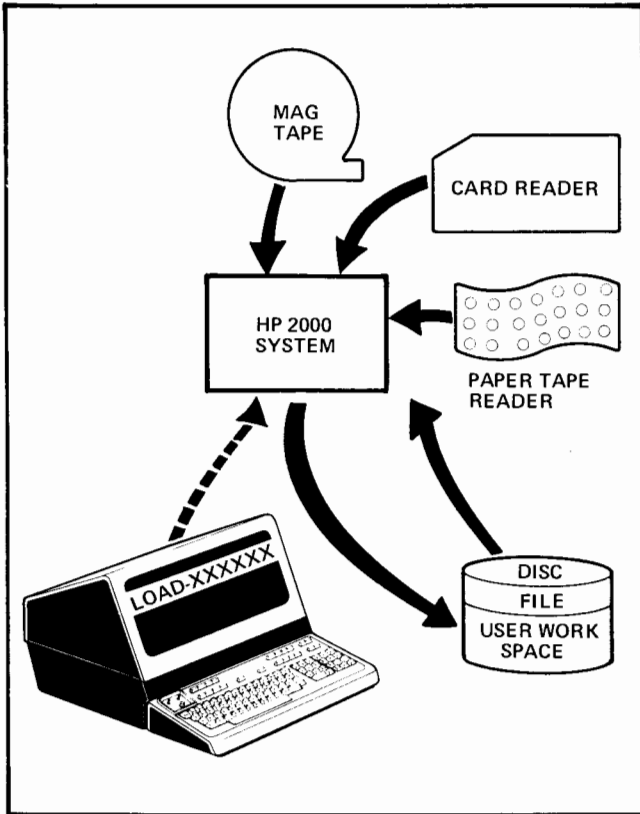

FORMATTED OUTPUT TO ASCII FILES

The **PRINT USING** and **MAT PRINT USING** statements now direct formatted output from programs to all types of ASCII files. As a result for example, formatted output can be transmitted directly to a line printer without the user typing the command **RUN*OUT=LP1***.

EXAMPLE

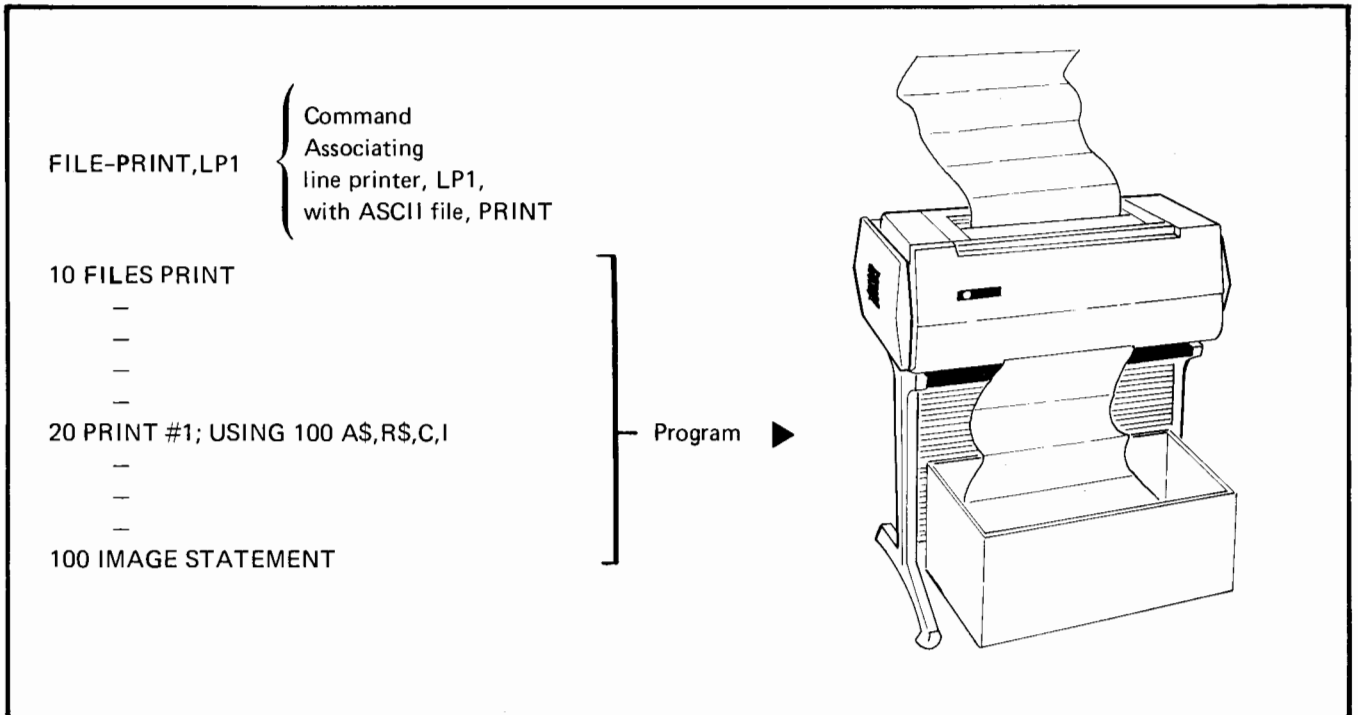

(For further information refer to the *HP 2000 BASIC Reference Manual* (22687-90001).)

NEW SYSTEM SOFTWARE FACILITIES

Several new system software facilities have been added to make application programming easier and more user-oriented.

1. PROGRAMMATIC DETECTION OF BREAK KEY

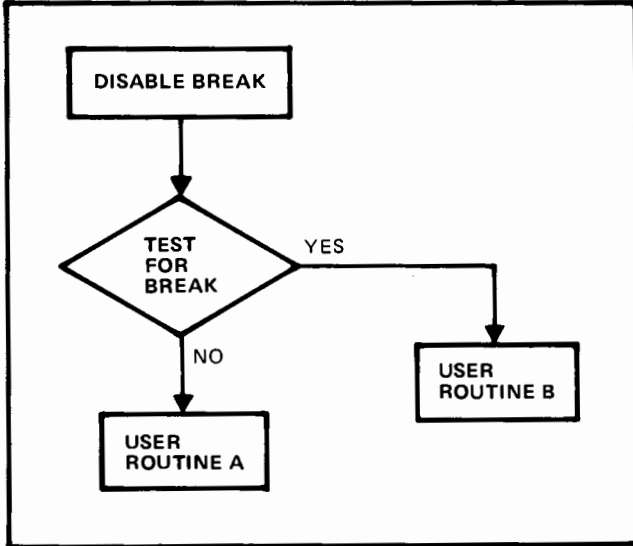

Previously, hitting the BREAK key terminated an executing program. If the BREAK was disabled, and no action was taken by the system when the BREAK key was pressed.

Now the application programmer can utilize the BREAK key to branch to a user-written routine. This is accomplished by executing the new SYS(3) function in an IF statement. (Refer to page 7-5 of the *HP 2000 BASIC Reference Manual* (22687-90001).)

2. PROGRAMMATIC DETECTION OF ERRORS

A new statement and function has been added to the HP 2000 BASIC language. The IF ERROR statement and the new SYS function now make possible the programmatic detection of programming, format and file errors.

IF ERROR statement

```
IF ERROR THEN <statement number>
```

Execution of IF ERROR sets a flag in a program to trap subsequent error messages. This statement will prevent the normal error message from being displayed and will branch to the error-handling routine specified in the statement number. This destination statement number may be altered by subsequent IF ERROR

statements. IF ERROR is disabled by a CHAIN, STOP, or END statement. Some caution must be used with this statement:

- a. An error diagnosed in mid-statement may lead to uninitialized variables, or partially updated files.
- b. Error-handling must be adequate for any error which IF ERROR may trap, for example: "DEVICE NOT READY."

(Refer to page 7-4 of the *HP 2000 BASIC Reference Manual* (22687-90001).)

SYS function

```
SYS (numeric expression)
```

The SYS function argument may be a number from zero to four (0-4). Depending upon the argument used with the SYS function, the system can return various information about the error trapped. SYS (0) tells the user what kind of error occurred by returning an error number. SYS (1) can be utilized to determine in which line the error occurred. Both of these values are reset to zero following execution. Therefore, a user wishing to interrogate these variables before branching to the appropriate error-handling routine must store them in other variables, e.g., E = SYS (0).

Other uses for the SYS function are as follows: SYS (2) can indicate the last file accessed in the program. SYS (3) is used for programmatic detection of the BREAK key after it has been disabled by the BRK function. SYS (4) returns the terminal type specified by the user at log in.

NOTE: Execution warnings are non-fatal errors which do not force the IF ERROR branch. The SYS function may be interrogated at appropriate points to determine if these errors have occurred. For example, consider the following statement: 200 A = B/B-1.

This may result in an attempt to divide by zero. IF ERROR will prevent the usual error message but will not branch to an error-handling routine. SYS (0) will, however, store the appropriate error number until SYS (0) is referenced, another error occurs, or IF ERROR is disabled.

3. SUSPENDING PROGRAM EXECUTION

The SYSTEM statement allows the user to execute programmatically some operating system commands, such as FILE, PROTECT, etc. PAUSE is a new com-

mand which can be used with this statement. The PAUSE command must be followed by a time limit within the range of 1 through 65, 535 seconds. The program will automatically restart at the end of the specified time limit. (The system operator may restart a program, if necessary, via the AWAKE command.)

This statement should prove helpful where the user would like to pause until output is complete. Another application may arise when IF ERROR traps DEVICE NOT READY errors. A SYSTEM N, "PAU-300" statement in an error-handling routine may allow the user to test again in 5 minutes to see if the device is ready.



DOCUMENTATION

New editions of the BASIC Reference and Operator's Manual, as well as new pocket guides, have been printed incorporating these features:

- HP 2000/Access BASIC Reference Manual, 2nd Edition, 5/76, 22687-90001 (\$10.00).
- HP 2000/Access Operator's Manual, 2nd Edition, 5/76, 22687-90005 (\$10.00).
- 2000/Access BASIC Pocket Guide, 3/76, 22687-90003 (\$1.50).
- 2000/Access System Operator's Pocket Guide, 5/76, 22687-90007 (\$1.00).

The existing BASIC Reference Manual (dated 9/75) is not necessarily obsolete; rather, it does not explain the software enhancements. However, the existing Operators Manual (dated 9/75) is obsolete. Please note the change in the terminal type parameters listed on page 1-10 of the new BASIC Reference Manual (22687-90001). Terminal type parameters have been revised to accommodate page mode support for HP 2640 and 2644 display terminals.

ORDERING INFORMATION

Customers under warranty or service contract will receive Revision 1628 at no cost. Customers not under warranty or service contract that wish to order Revision 1628 should contact their local HP representative for ordering details.

SOURCE DATA ENTRY ON THE HP 2000 ACCESS SYSTEM

Source data entry systems capture data at its source, and convert it into a form that can be entered directly into the computer system. The broad definition of these systems includes such devices as ten key pads, automatic timeclock systems, electronic cash registers, optical mark readers, optical character readers, and keyboard terminals in a non-keypunch replacement environment.

Many of the data entry problems have existed because someone has had to place the data on paper, and some time thereafter, someone else must read that data from the paper and enter it through a keyboard in order to put it into a form the computer can accept. To alleviate this type of problem, many companies have introduced source data entry systems.

Most potential users of source data entry systems are now looking for other capabilities that will operate concurrently with the data entry capabilities. Activities like remote job entry, local processing, high speed printing, editing and file utilities seem to be of primary interest.

The HP Source Data Entry, SDE/2000 (HP 20243A) is a software package written in BASIC, designed to use the capabilities of the HP 2000 Access system and HP 2640 series terminals to effectively distribute data entry, editing, and forms generation to the location of the source of the data.

SDE/2000 helps the forms designer to rapidly generate screen formats on the HP 2640 which can resemble the paper forms that his colleagues are already using. The screen formats can utilize the HP 2640 display enhancements of inverse video, underline, and half-bright in any combination. Shown below, in figures 1 and 2, is a two-part form, a purchase requisition.

DESIGNING A FORM

After completing the Forms Design, Start-up Screen (figure 3) the field description screen (figure 4) appears and is filled in once for each field you want to define.

Each screen can contain a form 22 lines long. The form is designed from top to bottom, each line from left to right.

Protected fields, those that the data entry person cannot enter data into, normally contain the field titles, headings, etc. as in DATE in figure 1.

```
CONTINUE REPEAT RETURN EXIT [ ]
PURCHASE REQUISITION ORDER
DATE [ ]/[ ]/[ ] NUMBER [ ]
BILL TO [ ]
[ ]
[ ]
SHIP TO [ ]
[ ]
[ ]
SHIP VIA [ ] PRIORITY [ ]
SUGGESTED VENDDR [ ]
```

Figure 1.

```
CONTINUE REPEAT RETURN EXIT [ ]
QUANTITY [ ] PART NO. [ ] EST. PRICE [ ]
DESCRIPTION [ ]
```

Figure 2.

In the fields where data will be entered (unprotected fields) from 0 to 5 editing functions may be defined. Data entered in a field can be made to remain on the screen, so it will not have to be reentered if it happens to remain constant from one instance of entering a screen of data to the next. This is done by entering YES to the DUPLICATION ALLOWED prompt.

After specifying from 1 to 5 edits for an unprotected field, the Edit Rule Screen (figure 5) will appear.

EDITING FUNCTIONS

The following error-checking/editing functions are available in SDE/2000 to check unprotected input fields. Up to 5 functions may be applied to each input field.

```

H.P. 2000 ACCESS SOURCE DATA ENTRY SYSTEM
FORMS DESIGN MODULE

NAME OF FILE WHICH WILL CONTAIN THE FORM DESCRIPTION      _____

NUMBER OF FIELDS TO BE DEFINED                            _____

NAME OF NEXT LOGICAL FILE IN SEQUENCE
<IF LAST SCREEN, USE NAME OF FIRST FILE>                 _____

IS THIS A CONTINUATION OF A PREVIOUS SESSION              _____
    
```

Figure 3. Forms design start-up screen

```

H.P. 2000 ACCESS SOURCE DATA ENTRY SYSTEM
FORMS DESIGN MODULE

SCREEN FILE NAME      OUTPUT.P102      CURRENT LINE NUMBER      1
LAST DESCRIPTION RECORD  0      CURRENT INDENT POSITION    1

CONTENTS OF FIELD      _____

DISPLAY ENHANCE CODE (BLANK TO N)  
LINE NUMBER                
INDENT POSITION      (1 TO 79)        
LENGTH OF FIELD      (1 TO 40)      
TYPE CODE              (P OR U)     
NUMBER OF EDITS      (0 TO 5)       
DUPLICATION ALLOWED (YES/NO)       
    
```

Figure 4. Field description screen

FIELD CHECKS	LOGICAL FUNCTIONS	TABLE FUNCTIONS	UTILITY FUNCTIONS
Alphanumeric Alphabetic Numeric Range Right justify zero fill Modulo 11 verify	Store, set, and test status of field check. Logical AND Logical OR	Table search Replace screen data with table data Dynamically select name of next screen.	Modulo 11 create check digit Field duplication on repeated screens Screen hold/reject Transfer contents of current field to next screen.

```

H.P. 2000 ACCESS SOURCE DATA ENTRY SYSTEM
FORMS DESIGN MODULE

EDIT RULE IDENTIFICATION NUMBER  ERROR OVERRIDE <YES-NO> 

LOGICAL TESTS
TEST FLAG  BEFORE DOING EDIT
AFTER EDIT
FLAG  MUST BE SAME AS OUTPUT FROM EDIT
FLAG  MUST BE OPPOSITE FROM OUTPUT FROM EDIT
AFTER EDIT SET
FLAG  WITH OUTPUT FROM EDIT

RANGE TESTS
VALUE LOW 
VALUE HIGH 

TABLE LOOK-UP
NAME OF FILE 

CURRENT DESCRIPTION RECORD
NUMBER OF EDITS SPECIFIED 
CURRENT EDIT RULE NUMBER 
    
```

Figure 5. Edit rule screen

```

H.P. 2000 ACCESS SOURCE DATA ENTRY SYSTEM
DATA ENTRY MODULE

SCREEN FILE NAME 
DATA FILE NAME 
ERROR OPTIONS
A REQUIRE CORRECTION AS SOON AS ERROR IS FOUND 
B INDICATE ERROR BY BLINKING FIELD ALLOW ERROR OVERRIDE
    
```

Figure 6. Data entry selection screen

Note also that the table look-up file name is specified on this screen. Details of the edit checks are included in the SDE/2000 Reference Manual (20243-90001).

ENTERING DATA

After the forms design is completed, data is entered by executing the program SDE.

(The form specifications are protected from accidental purge by a data entry person since data entry must take place under an ID different from the one under which the form was designed.) The screen shown in figure 6 is used as the front end for data entry.

The data entry person enters the name of the file where the form resides, the name of the file where the data will be

stored, and normally an "A" requiring any error that is detected be corrected before it goes to the file. The form is displayed next and data is entered.

Data entered anywhere on the screen can be edited locally within the HP 2640 at any time before the *ENTER* key is pressed since SDE/2000 operates in page mode. The *TAB* key is used to quickly position the cursor to the beginning of the next unprotected field. If the data entered fills a field, the cursor is automatically positioned at the beginning of the next field.

Several capabilities can be illustrated by examining the Purchase Requisition in figures 1 and 2. If *CONTINUE* is entered in the first field in figure 1, the data from this screen is written to the file and the next screen (figure 2) appears.

Often a purchase requisition contains more than one line of data of this type. If so, *REPEAT* can be entered in the first field keeping this form on the screen and clearing all unprotected fields where duplication is not allowed. A second item is then specified.

Note that there may be an arbitrary number of parts ordered on a requisition. Since different orders will have different numbers of items, this type of form can present problems. This problem can be avoided by splitting the form into multiple logical screens as done in this example. The second screen can be repeated as many times as necessary for each time the first screen is completed.

Data fields that are highly repetitive and complex; or that require special formatting, can be pre-stored and automatically supplied from a table. In this example, the description

is supplied from a table by matching with the part number. Placing an 'H' in the last field holds the description on the screen for visual verification. The data goes to the file after the 'H' is replaced by a blank and the *ENTER* key is hit again.

USER WRITTEN INTERFACE

User written programs can chain directly to the source data entry program if you want a custom fit for your application. Likewise, you can chain from SDE/2000 after data entry and editing, manipulate the data, then chain back. During this manipulation, you may want to prepare the data for local processing and/or remote job entry.

REQUIREMENTS

SDE/2000 will operate at data transmission rates up to 2,400 baud on hardwired HP 2640 terminals. The VADIC 3400 Modem can be used at 1200 baud full duplex on a single dial up line to give rapid forms display, or 110-300 baud modems and acoustic couplers can be used.

The HP 2640 CRT must contain the following minimum configuration:

- 2640A-001 128 Character Roman Set
- 13231A Display Enhancements
- 13234A Terminal Memory Module (+4K bytes)

A data sheet (5952-5566) is available from your local HP representative.

DISTRIBUTED SYSTEMS TIMEOUT VALUES

Mike Manley
HP Data Systems

There has been some confusion of timeout values in Distributed Systems (DS1B'). The correct timeouts are:

LINE SPEED	TIMEOUT VALUE
10 ⁶ bits/sec	100 (1 sec)
9600	1000 (10 sec)
4800	5000 (50 sec)
2400	6000 (60 sec)
1200	6500 (65 sec)
600	6500 (65 sec)
300	7000 (70 sec)

SUGGESTED TRANSACTION TIMEOUT VALUES

LINE SPEED	MASTER	SLAVE T/O
10 ⁶ bits/sec	5 (25 sec)	3 (15 sec)
9600	6 (30 sec)	4 (20 sec)
4800	12 (60 sec)	5 (25 sec)
2400	13 (65 sec)	7 (35 sec)
2000	13 (65 sec)	8 (40 sec)
1200	14 (70 sec)	9 (45 sec)
600	18 (90 sec)	12 (60 sec)
300	21 (105 sec)	17 (85 sec)

INDIRECT ADDRESSING

Steve Rutel
HP Data Systems

There is a symptom which has been brought to our attention concerning execution of floating point (FP), and extended arithmetic (EAU) firmware instructions with indirect addressing references on 2100A/S computers. This symptom arises from the fact that during execution of firmware FP and EAU instructions, front panel functions are not allowed, i.e. the HALT button will not halt the computer. This can create an inconvenience since the computer must then be turned off and brought back up. Valuable information and time may be lost if this situation is allowed to occur.

The design of the 2100A/S microcode is not at fault. To avoid getting locked up in the above manner, reevaluate the user software to eliminate any infinite indirect addressing references attempted by an FP or EAU firmware instruction. An infinite indirect addressing reference will cause the computer to stall when using FP and EAU software, but interrupts and halts are allowed.

Infinite indirect addressing references are always a problem but really goof you up when you are doing FP or EAU firmware instructions. To save yourself a problem always test bit 15 (the indirect bit) when calculating an indirect address in an algorithm.

7970E BOOTSTRAPPING

Steve Rutel
HP Data Systems

If you are experiencing problems when attempting to bootstrap a 7970E Mag Tape System (not MTRS) into a 21MX computer with a 12992D Mag Tape Loader Rom, the problem is most likely the 12992D Loader Rom. A new 7970B/E Mag Tape Loader Rom is being produced to correct the problem.

HP will be glad to replace the erroneous 12992D Rom with the new version, at no charge to you (this applies only if you have a 7970E Mag Tape Drive and are experiencing problems). If your machine was shipped prior to July 15, 1976, you most likely have the old rom (as of the writing of this article, all orders requesting a 12992D Mag Tape Loader Rom will be filled with the new part).

USING MULTIPLE CPU'S WITH ONE 7905A DISC AND RTE II/III

Jim Bridges
HP Data Systems

It is possible to have RTE II/III systems sharing a single 7905A disc. One way is to have one system per head (there are 3 heads). If each system begins at track zero, sector zero then all three systems are booted by standard ROM loaders. You probably would like to have some section(s) of the disc accessible to all systems. If the common area of the disc is initialized to FMP for more than a single system, this presents conflicts.

When a request is made to open a file, D.RTR validates the open flags in the directory to determine if the file is still in use. If the file is open to one or more programs, at least one flag is non-zero. Bits 14 to 0 is the ID segment address and, if the file is exclusively open, bit 15 is set to 1. The flag is cleared in the following cases:

1. It is already open to this program. A CLOSE is forced before the file is reopened.
2. An ID segment address found is not valid in this system. The keyword block is searched: the address must appear in this block.
3. A valid ID segment address found but the suspend address is zero. The program is assumed dormant.

Notice that these checks permit mobility of packs between systems and allow for programming errors (such as forgetting to close a file). But they inherently ignore the possibility that the pack is mounted to more than one system at a time.

Other problems can arise if two or more file managers are trying to create new files on the same FMP pack: the same directory sector may be modified by each file manager and the same tracks granted to more than one system for its own purpose.

The RTE II/III 7905A disc driver (DVR32) has a special

function which allows a program to perform a software lock on the drive. If the systems cooperate with each other, they can make use of this driver function to overcome conflicts.

The method of using the lock is described briefly in Appendix B of the RTE II/III reference manuals and is repeated here in more detail.

The FORTRAN code to utilize the lock function is as follows:

```

      ICODE = 12B
C ALLOCATE A RESOURCE NUMBER LOCALLY, LOCK IT GLOBALLY
      CALL RNRQ (ICODE,IRNUM,ISTAT)
C ISSUE FUNCTION CALL TO DVR32 TO LOCK DISC TO THIS SYSTEM
C NOTE: THIS IS A SOFTWARE LOCK FOR COOPERATING PROGRAMS
C AND/OR SYSTEMS. NO HARDWARE LOCK IMPLIED.
      CALL EXEC (3,IDLU+1500B,IRNUM)
C SYSTEM RETURNS WHETHER OR NOT LOCK IS GRANTED, SO PROGRAM
C MUST WAIT UNTIL THE LOCK IS GRANTED. THE ONLY WAY TO DO THIS
C IS TO ISSUE SINGLE REQUEST TO LOCK AND CLEAR. THE PROGRAM WILL
C THEN BE SUSPENDED IN GENERAL WAIT (STATE 3) UNTIL THE DRIVER
C CLEARS THE GLOBAL RESOURCE NUMBER PASSED TO IT.
      CALL RNRQ (5,IRNUM,ISTAT)
C WHEN LOCK IS GRANTED, DVR32 ISSUES REQUEST TO CLEAR GLOBAL
C RESOURCE NUMBER PASSED TO IT IN FOLLOWING MANNER:
C   LDA RN
C   JSB $CGRN
C   <return point>
C NOW THE DISC IS LOCKED TO THIS SYSTEM, BUT ONLY IF OTHER SYSTEMS
C USE THIS PROTOCOL. REMEMBER, THIS IS A SOFTWARE LOCK!!
C BETWEEN THE TIME LOCK IS REQUEST IS MADE AND WHEN IT IS GRANTED
C OTHER REQUESTS MAY BE MADE TO THE DRIVER. HENCE ONLY ONE PROGRAM
C IN EACH SYSTEM SHOULD MAKE LOCK/UNLOCK REQUEST.
C
      .....
      .....
C WHEN DONE UPDATING THE DISC, ISSUE UNLOCK REQUEST TO DVR32
      CALL EXEC (3,IDLU)
      .....

```

Internally, the way DVR32 handles the lock/unlock is to issue a request for unit 10 (decimal). This is a fictitious unit (does not exist) and always reports clear status. When it gets the attention of unit 10, the driver issues a recalibrate command with HOLD. When the driver receives the unlock function code, it issues a recalibrate command with CLEAR. In between the HOLD and the CLEAR, no other system can use unit 10. However, other systems can use the disc: it is not protected against access. Hence the need for systems to cooperate in using the lock/unlock feature of the driver effectively, unit 10 becomes a resource to cooperating systems.

The operating system does not support the lock/unlock feature of the driver. It is up to the applications "package" to creatively manage whatever conflicts may come up. The driver does issue all requests with the HOLD bit set and

clears the hold when the request is complete, however, a single request to write or read is safe from other requests. For example, if system A seeks one track, it holds the disc until the read/write is complete. This prevents system B from seeking another track before the read/write has been accomplished. But there are no features in the system which will prevent system B from defeating anything system A wants to do — even when the lock is on.

FORMAT OF DATA FILES IN MULTI-USER REAL TIME BASIC

Jim Bridges
HP Data Systems

By knowing exactly how BASIC stores and retrieves information on data files, you can optimize the use of disc space. In

addition, this knowledge permits sharing a data file between a BASIC program and a program written in some other language (e.g. FORTRAN).

To illustrate this, use FMGR and create a data file as follows:

```
:CR,DATA:::1:4      <Type 1 file, 4 blocks long>
```

The following BASIC program will clear the file to all binary zeroes:

```
10  REM CLEAR DATA FILE TO ZEROES
20  FILES DATA
30  IF END #1 THEN 60
40  PRINT #1;0,END
50  GO TO 40
60  END
```

The next program will fill the data file with sample data to show the format. (See the actual listing of the file done by FMGR.)

```
10  REM FILL DATA FILE WITH SAMPLE DATA
20  REM TO SHOW FORMAT OF FILE
30  FILES DATA
40  IF END #1 THEN 100
50  PRINT #1,1;2,"123",0,1
60  READ #1,2
70      FOR I=1 TO 40
80          PRINT #1;-2,"123",END
90      NEXT I
100 END
```

Notice that all data are either floating point numbers or character strings (no integers). A string is preceded by an identifier: in the top byte is the "type," which is 2. In the bottom byte is the character count for the string. If an odd number of characters, the last word is padded with a binary zero in the low byte.

How do you distinguish a string identifier from the first word of a floating point number in the file? The answer is that, if a floating point number is non-zero, either bit 15 or bit 14 (not both) will be set in the first word. This is the specification for "normalized" format.

The following are "markers" placed after the record by BASIC:

```
-2  (177776) = End of Record
-1  (177777) = End of File
```

The EOR (end of record) is written after every record which does not contain an "END" in the data list. The EOR is overwritten by the next record written in serial mode unless the next item would cross into the next block: then the EOR is saved to indicate no more valid data in the block (to

avoid straddling the boundary) and additional data are placed in succeeding blocks. If the last item in the data list is "END," then the EOF (end of file) marker is written instead of the EOR at the end of the current record. However, the next serial write also overwrites the EOF marker.

When doing serial reads, EOR markers are ignored: but a direct read will not cross the block boundary. If the data list for input is greater than the number of items in the block, an error break occurs in the program for a directed read only.

The action taken on error break is as follows:

1. If END <file number> THEN <line number> is included in the program, then the branch to <line number> occurs.
2. If no precaution as described above, then the program will terminate with an error message.

A directed READ or write (PRINT) is distinguished by the presence of a record number in the statement. A directed READ or a directed PRINT always starts at the beginning of the block which is accessed. For example, two directed READ's with the same record number picks up the same data.

There is only one data pointer per file and it is used for both READ and PRINT statements referring to that file. The pointer may be positioned by a directed READ with a null list, e.g.

```
READ #1,N          (Position file #1 to record N)
```

At the start of the program, all pointers are set to the first record (record #1). From any record position in the file, the program may begin either directed or serial READ's and/or PRINT's. Thus, by using a directed READ, the pointer may be moved beyond any EOF markers in the file. Using serial READ's, the program cannot get beyond an EOF. Therefore, when using directed READ's the program must test for an EOF marker if it chooses to recognize a file size less than the physical limit.

In the sample DATA file we have created, record #3 contains an EOF and record #4 is cleared (all zeroes) (Refer to figure 1). If we position to record #4, i.e.

```
READ #1,4
```

then successive READ's (direct or serial) would pick up floating point zeroes. If a READ beyond the physical end of file were attempted, it would be treated as if an EOF marker had been found.

"FORTRAN IV I/O" USING "ASSIGN" STATEMENTS

Del Kittendorf
HP / Orlando, Florida

Looking for a way around the use of the Formatter for simple I/O calls? Here is a method for storing ASCII data in arrays without using data statements.

The FORTRAN IV ASSIGN X TO Y statement is used in Assigned GO TO statements. It operates as follows:

ASSIGN X TO IY — where X is a statement label and IY is an integer variable.

This will place the address of "x" (address of a statement label) into variable IY. Thus, any reference to IY now will operate on an address of statement "x."

e.g. 100 A = B+C
 ASSIGN 100 to IY

IY now contains the address of the first assembly level instruction in 100 A = B+C.

Not too useful you say? Consider this sequence.

```
DIMENSION IY(0)
100 FORMAT ("THIS IS A HEADING")
ASSIGN 100 to IY (0)
IY (0) = IY (0)+1
CALL EXEC (2, IY, etc.)
```

Now, this assembles as follows:

```
DIMENSION IY(0)
DEF x + 1
BSS 0
(Program Body)
100 FORMAT ("This is a Heading")
ASCII, ("This is a Heading")
etc.
```

Thus, after the ASSIGN: IY (1) points to ("
IY (2) points to TH
IY (3) points to IS
etc.

The statement IY (0) = IY (0)+1 just moves the array pointer past the (") so that after that statement:

```
IY(1) = TH
IY(2) = IS
etc.
```

This is a quick and dirty method of setting up ASCII arrays without all of the DATA IY/2HTH, 2HIS, etc./ statements. It also allows you to do ASCII I/O without the FORMATTER.

HOW TO OPTIMIZE THE SEARCH TIME IN YOUR IMAGE/1000 DATA BASE

Carol Gilstrom
HP Data Systems

The search time for key item values can have a great effect on the efficiency of your data base. The search time can be optimized by carefully determining the value of the capacity count for master data sets. When the search time is optimized, the efficiency of programs accessing the data base will be greatly increased.

PRIMARY AND SECONDARY ENTRIES

Before we can discuss the role the capacity count plays in optimizing the search time, we have to understand how IMAGE maintains master data sets.

IMAGE makes entries into a master data set by performing a hashing function upon each key item value to obtain the record address of the entry. Each entry is made up of a media record (which contains information about that entry and pointers to every detail data set linked to it) the key data item value, and, if the data set is a manual master, any other data item values associated with the master data set.

The first word of the media record is the entry indicator. A zero indicates an empty record (a record in which no entry has been stored). A one indicates a primary entry. That is, IMAGE has hashed the key item value of this entry directly into this record address. A negative one in the first word indicates a secondary entry. That is, IMAGE hashed the key item value into a record address that already contained a primary entry. A serial search was then performed to find the next available empty record in which to store the entry. If a key item value directly hashes into a record that already contains a secondary entry, the secondary entry is moved to the nearest empty record and the primary entry is inserted.

An abundance of secondary entries in a master data set contributes to a chaining effect which can considerably lengthen the search time for a key item value. So, in order to optimize the search time, it is necessary to find some way to minimize the number of secondary entries in the master data sets.

USING THE CAPACITY COUNT

To minimize the secondary entries in your master data sets use a prime number (or the product of two or more prime numbers) for the capacity count. The capacity count is used as a divisor in the hashing function, and prime numbers generate more unique record addresses.

To illustrate the effect of the capacity count on the primary and secondary entries, a data base containing one manual

master data set was created and filled to capacity. The following four tests were run twice, once with a capacity of 2000 and once with a capacity of 2003:

1. Key item declared as an integer and the values were all positive.
2. Key item declared as an integer and the values ranged from negative to positive.
3. Key item declared as six ASCII characters and the values were all positive integers.
4. Key item declared as six ASCII characters and the values ranged from negative to positive integers.

The results of these tests are shown in Figure 1. You will notice how the ratio of primary to secondary entries almost reversed between the two capacities.

VERIFYING THE RESULTS

A short program can be written to retrieve the entry ratio information about your master data sets as the media record is returned as part of the entry. The media record appears in front of the entry in the buffer. Figure 2 is an example program to retrieve the ratio information.

By choosing the capacity count wisely and using a short utility program to test the result, the search time for key item values can be minimized and the efficiency of programs accessing the data base increased.

KEY ITEM TYPE	CAPACITY COUNT			
	2000		2003	
	PRIMARY	SECONDARY	PRIMARY	SECONDARY
POSITIVE INTEGERS	125	1875	1513	490
NEGATIVE & POSITIVE INTEGERS	250	1750	1502	501
POSITIVE ASCII INTEGERS	537	1463	1137	866
NEGATIVE & POSITIVE ASCII INTEGERS	343	1657	1120	883

Figure 1. Effects on Primary and Secondary Entries

```

PROGRAM UTILT(3,90)
DIMENSION IBASE(3),ILEVL(3),ISCOD,IDSET(3),
DIMENSION ISTAT(4) IBUF(256),ILIST(4)
DATA ILIST/1,2HUT,2HIL,2HT /,ITS/2HS /
DATA IBLK,IPRI,ISEC/0,0,0/

C
C ENTER DATA BASE INFORMATION FROM
C SYSTEM CONSOLE
C
WRITE(1,100)
100 FORMAT("ENTER DATA BASE NAME:")
READ(1,200)IBASE
200 FORMAT(3A2)
WRITE(1,300)
300 FORMAT("ENTER USER LEVEL I.D.:")
READ(1,200)ILEVL
WRITE(1,400)
400 FORMAT("ENTER SECURITY CODE:")
READ(1,*)ISCOD
WRITE(1,500)
500 FORMAT("ENTER DATA SET NAME:")
READ(1,200)IDSET

C
C INITIALIZE AND OPEN THE DATA BASE
C
CALL DBINT(IBASE,ILEVL,ISCOD,ILIST,ISTAT)
CALL DBOPN(IBASE,ILEVL,ISCOD,1,ISTAT)

C
C GET THE DATA SET NUMBER
C
CALL DBINF(ITS,5,IDSET,IBUF)
ID=IBUF(2)

C
C GET THE CAPACITY COUNT
C
CALL DBINF(ITS,2,ID,IBUF)
ICAP=IBUF(6)

C
C DO A DIRECTED READ ON THE DATA SET
C
DO 700 IARG=1,ICAP
CALL DBGET(IDSET,3,ISTAT,IBUF,IARG)
IF(ISTAT.EQ.0) GO TO 600
IBLK=IBLK+1
GO TO 700
600 IF(IBUF(1).EQ.1)IPRI=IPRI+1
IF(IBUF(1).NE.1)ISEC=ISEC+1
700 CONTINUE

C
C WRITE RESULTS ON SYSTEM CONSOLE
C
WRITE(1,800)IBLK,IPRI,ISEC
    
```

Figure 2. Program to Retrieve Ratio Information

about the HP 9600/9700

```

800 FORMAT(//,1X,"EMPTY RECORDS = ",I5,/,1X,
1"PRIMARY RECORDS = ",I5,/,1X,"SECONDARY
RECORDS = ",
2I5,/)
C
C CLOSE THE DATA BASE
C
CALL DBCLS(0,ISTAT)
END

```

Figure 2.
Program to Retrieve Ratio Information (Continued)

KNOW YOUR RTE, PART 4

by Mr. RTE

This is the fourth of a series of articles in the **Communicator** dealing with the inner works of HP's RTE systems. These articles go into some detail on how the system works; therefore, you should have already read and become familiar with the material in the RTE reference manual to your system.

Last time we traced an operator request up to the \$MESS routine in the SCHED module of the system. Now let's take a request through \$MESS and see what we can learn.

A principle you might want to keep in mind is that the hardest thing an operating system (any operating system) has to do is abnormally terminate a program (next hardest is the normal terminate). The reason for this will become clearer as we progress, as we choose to use an 'OF' request to examine \$MESS.

THE \$MESS FRONT-END

The following things are done for all calls to \$MESS:

1. The command's existence is verified
2. The command is parsed
3. The command is dispatched

The first of these operations is done by checking the transmission log. If zero characters were received, \$MESS just exits.

The second operation is a bit more involved. The end result of the parse is described in your RTE manual under "PARSE" in the library section. Internally we will only say that the parse routine looks for numbers first, and, when this fails assumes ASCII.

After the command is parsed, it must be dispatched. This is done by a table look up.

Commands not in the table are dispatched to a routine which returns the proper error.

Errors are returned to the caller of \$MESS to be printed in the proper place (or not at all). Remember \$MESS can be called from a program via MESSS (see the library section of your manual).

THE 'OF' COMMAND

Since we started out tracing the "OF" command, we should now have arrived at the routine which is to process the "OF" request. The OF command has several options; i.e., zero, not zero, and, as a subset of not zero, eight. This option is the third element in the parsed command. (The first element is OF, and the second is the program name.) In the general case, the ID segment is found by calling the handy dandy routine, TTNAM, which is an internal subroutine. If the reference is to a short ID segment (i.e., for a background segment), most of the following is skipped. We will indicate where the system picks up the short ID segment when we get to it. If the OF option is zero then the routine SABRT is called. This is the soft abort routine, soft in that it doesn't do the things that a hard abort does.

The first thing SABRT does is to clear the 'R' bit in the status word (remember the first article of this series?) This will force the list processor (\$LIST) to truly put the program dormant. The system then calls \$TREM (in RTIME), which will remove the program from the time list.

The system then checks the program's 'W' bit. If the 'W' bit is set, the program has scheduled another one with wait, and we are about to abort his father. In this case the system must clear the 'father is waiting' (FW) bit in the son's ID segment (word 21).* This prevents the system from going astray when the son terminates.

The system at this time calls the TERM subroutine which is even softer than soft abort (it is used for standard terminations). The TERM routine first calls the list processor to put the program dormant. If the father's waiting bit is set for *this* program, then the system finds the father and clears his 'W' bit. Since he's no longer waiting (and he was waiting if the 'W' bit was set) and if he is in state 3, the list processor is called to schedule him. It is possible that the father is waiting but is not in state 3. This would indicate that he is possibly dormant because his father made him dormant or that he is in another state with the 'W' bit set. For this reason he is rescheduled only if he is in state 3. For other cases the list processor picks up the fact that he should be scheduled by the indication that was left by clearing the 'W' bit. The TERM

*See the ID segment map in Appendix A of your RTE manual.

routine then clears all but the "RM," "RE" and "RN" bits in word 21 of the program being put dormant, and returns. The RN flag in word 21 of the ID segment indicates that the program has resource numbers. The RM flag indicates that it has re-entrant memory that has been moved. These resources will be released by DISPA when it finds the program linked into the abort list at "\$ZZZZ" (see the discussion of \$LIST in a previous issue).

We have now traced the system back to the SABRT routine, which, at this point, checks to see if TERM found a father to the program being aborted. If a father exists, SABRT will set a 100000B (sign bit only) in word 2 of the father's ID segment and will set the father's B register (at XB, word 11) to point to this word. This allows the father to do a RMPAR call and to get back a word (the first of 5) that indicates that the son program was aborted. This is how FMGR, for example, knows to generate the "ABEND XXXXX ABORTED" message. This ends the SABRT routine so we now return to the 'OF' processor which returns to \$XEQ in DISPA. We have just gone through an OF,XXX. Now we will consider the case where the option on the 'OF' is non zero.

In the non-zero case, the system checks to see if the program is I/O suspended (major state=2). If the program is I/O suspended a JMP to \$IOCL in RTIOC is executed. \$IOCL must first find the program in the I/O queue of one of the EQTs, so a scan is made of each EQT's queue. A program may be in I/O suspend for loading in which case the entry in the I/O queue is for the DISPATCHER and not the program. In this case the entry will not be found so \$IOCL calls \$ABRT in SCHED to finish the abort.

\$ABRT THE HARD ABORT ROUTINE

\$ABRT sets the abort ("A") bit in the programs status word (recall that we discussed this bit in the \$LIST discussion). The "A" bit being set indicates a hard abort to \$LIST and forces it to set the program dormant. \$ABRT then calls SABRT which we just discussed. \$ABRT then calls \$SDRL in EXEC which releases any disc tracks the program owns, and, if any are released, calls \$LIST to schedule all programs waiting for disc tracks. The exception here is that \$SDRL will not release tracks belonging to either D.RTR or EDIT. After \$SDRL returns, \$ABRT sets up the program abort message and sends it to \$SYMG in RTIOC which will send it to the system console.

Note that the abort message goes directly to the system console rather than being passed back through \$MESS. This is because \$ABRT is called by \$SERMG in EXEC which is invoked by MP, IO, SC, RQ and other such errors. This implies the \$ABRT need not have been called by \$MESS at all but is usually called as a direct result of a program's transgression of some system law. At this point \$ABRT returns, in our case, to \$IOCL in RTIOC.

The alternate path in \$IOCL is where the program is found in an I/O queue. In this case the program's request is removed from the queue, and if the request is not a system request, \$ABRT is called. If the request is a system request, it indicates that the call to \$IOCL is being made by DISPA to clear a load or swap request. In this case the system is not working with an ID-segment and an abort message must not be generated.

If the I/O entry was not the first one in the queue or if it was not found \$IOCL exits to \$XEQ at this point.

If it was the first entry, the current on going I/O request must be stopped. To do this the EQT entries are set up on the base page, the DMA channels assigned to the EQT, if any, are released and the driver is called with a control request, sub-function 0. This request is defined as a clear request. If the driver accepts the request: a) a timeout of 1 second is set up and b) a flag (bit 15) is set in EQT word 1 for the device c) \$IOCL exits to \$XEQ. If the request is not accepted, control is passed to IOCOM in RTIOC to start the next request in the EQT's queue. We will not trace this request at this time but will conclude the discussion by indicating the IOCOM will eventually return to \$XEQ.

You will recall that we went to \$IOCL only if the program was I/O suspended. If the program is not I/O suspended and the "OF" option is non-zero the 'OF' processor calls \$ABRT and then joins the "OF" code to handle the "OF" requests directed against short ID segments. At this point a check is made for the "8" option of the OF request. If it is not an 8 option or if the TM bit is not set in ID-segment word 15, the OF processor exits to \$XEQ.

If the TM bit is set, it indicates that the program was loaded temporarily online, and that there is no copy of its ID-segment on the disc. Only in this case can the OF processor clear the ID-segment. The rest of the OF code computes the number and location of the tracks holding the program and calls \$DREL in EXEC to release the tracks. The OF request assumes an ID segment owns a track only if it references sector 0 on that track. This convention prevents double release of tracks in cases where background segments start in the middle of a track. Furthermore, \$DREL will only release the tracks if they are owned by the system (i.e., it will not free FMP tracks). \$DREL also reschedules any programs waiting for disc tracks by calling \$LIST.

When \$DREL returns, the OF routine clears the 3 name words (except for the SS bit, which indicates a short ID-segment, and the track assignment words) and then goes to \$XEQ.

In this series, we have now discussed the list processor \$LIST, the start up procedure, slow booting, and the OFF routine. In the next article, we will attempt to clarify an I/O request.

Software Sam



We all need a vacation sometime. See you next issue !

If you have questions, suggestions, or comments about your 9600 system, let SAM help. Write to:

SOFTWARE SAM
c/o Communicator 9600/9700 Group
HP Data Systems Division
11000 Wolfe Road
Cupertino, CA 95014

bulletins

NEW TRAINING COURSE DATA SHEETS

Jane Seligson
HP Data Systems

Data Systems training course data sheets have just been released for the three new courses. They are Image DBMS 1000 (5952-9944), HP-IB Minicomputer Bus Basics (5952-9945), and HP-IB Programming under RTE (5952-9946). Extra copies are available from the literature department, bldg. 9B in Palo Alto.

NEW RELEASES FROM THE 2100/21MX CONTRIBUTED LIBRARY

Melanie Van Vliet
HP Data Systems

This article serves as an update for the 2100/21MX Contributed Library Program Catalog (22999-90040). The new contributed programs listed below are now available. Contact your local HP sales office to order Contributed Library material, or (if you are in the U.S.) you can use the Direct Mail Order form at the back of this publication.

Order No.	Description and Price
22681-18961	<p>OCTASET</p> <p>This is a troubleshooting aid for computer service engineers and programmers. It eliminates time consuming switch register toggling by performing the following functions on line in Real Time:</p> <p>ASSEMBLY INTO CORE WRITE ABSOLUTE TAPE FROM CORE LOAD ABSOLUTE TAPE TO CORE VERIFY ABSOLUTE TAPE TO CORE LIST MEMORY BOUNDS OF ABSOLUTE TAPE DUMP CORE TO TTY (OCTAL & INVERSE ASSEMBLY) JUMP TO ANY LOCATION IN CORE SEARCH CORE FOR ANY OCTAL VALUE</p> <p>OCTASET is configured, self-contained, and needs no other drivers or routines. It resides within the bounds of a single page in core. Operator communication was a prime consideration in its design and anyone familiar with HP Assembly Language can master its use in a very short time. Minimum configuration is an 8500 Console (min.) although a tape unit extends its usefulness considerably.</p> <p>\$10.00</p>
22682-18916	<p>2000E DISC CHECK UTILITY PROGRAM (TSEDP)</p> <p>This program will read a 2000E TSB disc cartridge, either system or user, and validate it as being correctly labeled. It will then either list the ADT and Directories or check the ADT and Directories for valid entries.</p>

ADT: The pseudo entry at the end if checked first, then each entry is checked to be sure that it references the correct area of the disc and that it references only one track. Finally the entries are checked to be sure they do not overlap.

DIRECTORY: The two pseudo entries are validated, then the disc addresses are checked along with the start-of-program-pointer and the program length. The adjacent directory disc addresses are then checked for overlap and if there are two directory tracks each track is checked against the other for overlap. Finally the ADT disc addresses are checked against the Directory disc addresses to be sure there are no ADT/Directory conflicts.

\$10.00

22682-18917 FIXED HEAD DISC DIAGNOSTIC

This diagnostic program tests input, output and control functions of either the HP 2773, 2774 or 2775 Drum, or the HP 2770, 2771 or 2766 Disc device with the HP 12606 or 12610 interface. The program rapidly checks the interface and exhaustively tests the disc device itself. The user may also design his own tests for specific functions. This diagnostic does not check more than one disc or drum at a time.

Hardware requirements; HP 2100 or 21MX computer with DMA (DCPC in 21MX) and at least 8K of memory. Any of the following;

1. HP 2773 or 2774 drum with HP12610B interface and HP 2776 power supply.
2. HP 2775 drum with HP12610B interface and HP 2777 power supply.
3. HP 2770 or 2771 disc with HP 12606B interface and HP 2772 power supply.
4. HP 2766 disc with HP 12610C interface and 2772 power supply.

A console and paper tape reader are also required.

\$85.00

22682-18918 OPTIONAL DVR51 – RTE AUTO DIAL DRIVER FOR 12589A INTERFACE KIT

This RTE Auto Dial Driver uses 12589A interface kit to operate on Automatic Calling Unit (ACU). Use of this along with complementary Auto Answer Units in a distributed communication system, allows line connections and disconnections to be made automatically under program control. The driver supports "write" requests to enable dialing and "control" request to do a disconnect. Line selection from 1 to 4 is permitted by software although the current cable assembly of 12589A allows for one line only (with reference to multiple ACU's being connected to the same interface board). The driver handles its own time out and status word reflects "on-line" and "off-line" condition on completion of request. "End-of-number" option is also supported in software allowing line to be handed over to the modem while it is ringing. Appropriate time out values (negative digits) may be inserted in the dial buffer at places where dial tones are expected. This is important in case of a multiple dial sequence over an ACU which does not support "positive dial tone identification"; e.g. Bell 801A. If an ACU does support this feature (e.g. Vadic Corp's ACU), illegal digits should be inserted in the write buffer at dial tone points. The overall driver time out value (in EQT14) set at system generation time is independent of the time-out values specified within the dial sequence in case of random dialing and should preferably be greater than the ACU's timer.

\$50.00

22682-18919 MAPIO

This program prints a compact table by logical unit of any RTE I/II or III I/O configuration. The map includes the LU, EQT, select code, sub-chan and channel, EQT address, driver address, and device type. The output can be sent to any device and device names can be changed by the user.

\$20.00



CONTRIBUTED PROGRAMS (Continued)

Order No.	Description and Price
22682-18920	<p>THIRTY-ONE ODD</p> <p>This is a game in which the player is pitted against the computer. To win, the player must end with an odd total of counters when the kitty is exhausted. The kitty starts with 31 counters. The player chooses whether to go first or to have the computer go first, then the computer and the player alternate choosing between 1 and 5 counters to be added to their totals. The computer plays an optimum game with only 3125 ways to lose. The player, however, has almost 10 million ways to lose so that completely random choices will rarely lead to a win. Hardware required is 4K and a TTY.</p> <p style="text-align: right;">\$10.00</p>

software updates

Listed below are the software parts and manuals which are shipped with RTE-II and RTE-III systems. Revision levels (A, B, C, D, etc.) or date codes (1543, 1546, etc.) are included for your reference.

SOFTWARE	RTE II	RTE III
Core Res Sys Loader	92001-16012 1602 92001-16002 1616	92060-12003 1604 92060-16004 1616
Multi Term Monitor	92001-16003 B	Same
Sys Library	92001-16005 1545	Same
DVP43 (Power Fail)	92001-16004 1602	92060-16001 1602
Autor (Auto Restart)	92001-16014 B	Same
Autor Source	92001-18014 -	Same
Spool Monitor	92002-12001 B- Option Y13	Same - no option
Spool Program	92002-12002 D- Option Y13	92060-12001 B
Batch Monitor Libr	92002-16006 D- Y13	Same
EDITR	92002-16010 C- Y13	Same
EDITOR	20805-60001 C	Not included
DVR00	29029-60001 1543	Same
DVR31 (7900 Disc)	29013-60001 C	Same

DVR32 (7905 Disc)	92060-16031 A	Same
7900 System Generator	92001-16013 1602	92060-16029 1602
Fixed Head Generator	92001-16018 1602	Ndt Supported
7905 System Generator	92001-16026 1602	92060-16032 1602
WHZAT	Not Available	92060-16006 B
Assembler XREF	92060-12004 92060-16028	Same Same
\$PVMF	Not Applicable	92060-16035 A
FORTRAN II	20875-60001 E 20875-60002 E 20875-60003 E 20875-60004 E 20875-60005 E	Same Same Same Same Same
FORTRAN IV	24170-60001 C 24170-60002 C 24170-60003 C	Same Same
FORTRAN IV (10K Area)	24177-60001 1442 24177-60002 1442	Same
ALGOL	24129-60001 C 24129-60002 C	Same Same
FTN II FORMATTER	24153-60001 C	Same
RTE/DOS LIB	24998-16001 1610	Same
FTN IV FORMATTER	24998-16002 1610	Same
DR-SIO DMA 9TR	12970-16003 1518	Same
16K SIO MAG TAPE 9 TR	13022-60001 B	Same
16K SIO MAG TAPE 7 TR	13030-60001 B	Same
16K SIO PAPER TAPE RDR	20319-60001 A	Same
16K SIO PAPER TAPE PUNCH	20320-60001 A	Same
16K SIO SYSTEM DUMP	20335-60001 B	Same
16K SIO TTY (LP COMPAT)	24127-60001 A	Same
16K SIO 2767 LP	24166-60001 B	Same
16K SIO 2762/2615	24329-60001 A	Same
16K SIO 2607 LP	24347-16001 1346	Same
24K SIO LP DVR	02607-16004 1538	Same
24K SIO TTY (LP COMPAT)	29100-60017 A	Same
24K SIO SYSTEM DUMP	29100-60018 A	Same
24K SIO PAPER TAPE RDR	29100-60019 A	Same
24K SIO PAPER TAPE PUNCH	29100-60020 A	Same

SOFTWARE	RTE II	RTE III
24K SIO 2767 LP	29100-60022 A	Same
24K SIO MAG TAPE 9 TR	29100-60023 A	Same
24K SIO MAG TAPE 7 TR	29100-60049 A	Same
24K SIO 2762/2615	29100-60050 A	Same
24K SIO MT DMA	12970-16004 1550	Same
Manuals		
RTE REFER-ENCE ASSEMBLER FORTRAN II FORTRAN IV ALGOL	92001-93001 - 92060-90005 - 02116-9015 - 5951-1321 - 02116-9072 -	92060-90004 Same Same Same Same
SIO DVR 2762/2615	02762-90002 -	Same
SIO DVR 2767 LP	12653-90004 -	Same
SIO DVR 2607 LP	12987-90006 -	Same
SIO DVR 7970 B/E 9 TR	13022-90010 -	Same
SIO DVR 7970B 7 TR	13029-90010 -	Same
SIO INTRO	5951-1369 -	Same
SIO SYS CONFIG.	5951-1374 -	Same
SIO SUBSYS	5951-1390 -	Same
DVR00	29029-95001 -	Same
M-2600 SIO PRGM	02116-91760	Same
MANUAL 12970	12970-90901	Same
MNL RTE/ DOS LIBR	24998-90001	Same
MNL RTE POCKET GUIDE	92060-90010	Same
RTE SYS DVR/ DEV SUBR	92200-93005	Same
MNL RTE INTERACV ED MNL	92060-90014 - Option Y13	Same - No option
RTE BATCH SM MNL	92060-90013 - Option Y13	Same - No option
RTE NEW USERS GUIDE	Not applicable	92060-90012

Following is a list of the drivers, (with part numbers, and revision levels) available for RTE systems.

RTE DRIVERS

DRIVER	PART #	REV LEVEL	DESCRIPTION
DVR00	29029-60001	1543	
DVR11	29030-60001	B	2892 Card Reader
DVR12	29028-60002	A	2767 Line Printer
DVR12	92001-16020	1534	26XX Line Printers
DVR31	29013-60001	C	7900 DISC
DVR32	92060-16031	A	7905 DISC
DVR15	09601-16021	A	7261A Card Reader
DVR23	92202-16001	A	9 Track MT
DVR30	20747-60001	C	Fixed Head DISC
DVR24	25117-60499	D	7 Track MT
DVR72	09611-16005	A	6940 A/B Local & Remote
DVR62	02313-16001	A	2313B DVR
	29009-60001	C	2313B DVR
	29011-60001	E	R2313

DOS-IIIB MODULES

The Index below indicates the modules available for DOS-IIIB systems, HP 24307B, date code 1523.

This Index relates the names of the relocatable modules to the part numbers of the equivalent paper tapes and indicates the purpose of the modules. Modules not specifically designated for the 2100A/S or for the 21MX computers are to be used on either.

NAME	PART NUMBER	REV	DESCRIPTION
DISCH	24307-16069	1523	DISC MONITOR
\$EXMDD	24307-16070	1523	EXEC MODULES
DVR00	20985-60001	1516	TTY-LIKE CONSOLE/ TERMINAL
DVR01	20987-60001	1419	PAPER TAPE READER
DVR02	20989-60001	1419	PAPER TAPE PUNCH
DVR05	24157-60001	1419	TTY-LIKE CONSOLE
DVR15	24307-16017	1446	7261A MARK SENSE CARD READER
D2892	24272-60001	1419	2892B CARD READER (DVR11)
D2767	24168-60001	1419	2767A LINE PRINTER (DVR12)
D26XX	24307-16011	1446	DVR12 FOR 2607, 2610, 2614, 2613, 2618
DVR23	13024-60001	1446	7970B/E MAG TAPE
DVR26	24307-16018	1507	2762A/B AND 2615A CONSOLE
DVR30	24307-16073	1523	DISC BATCH DRIVER
DVR31	24156-60001	1419	7900/7901 DISC
DVR67	24341-60001	1419	12889A HI SPD SERIAL IF
DVR70	24307-16009	1446	DVR70 FOR 12618A SYNC INTERFACE
DVR71	24307-16013	1515	12967A SYNCH MODEM IF
DVR72	24350-16001	1523	12587B ASYNCH DATA SET IF

about the HP 9600/9700

NAME	PART NUMBER	REV	DESCRIPTION
DVR73	24377-16001	1523	12920A/B MULTIPLEXOR
DVR74	24307-16014	1515	12966A/12968A ASYNCH IF
EFMP	24309-60002	1523	EXT FILE MGR EXEC MODULES
	24309-60003	1523	EXT FILE MGR UTILITIES
JOBPR	24307-16071	1523	JOB PROCESSOR
RLODR	24307-16072	1523	RELOCATING/LINKING LOADER
ASMB	24307-16006	1419	2100/21MX ASSEMBLER
.FTN4	24170-60001	C	FORTRAN IV COMPILER
	24170-60002	C	
	24170-60003	C	
FTN4	24177-60001	1442	FORTRAN IV COMPILER (10K AREA)
	-60002	1442	
ALGOL	24129-60001	C	ALGOL COMPILER
	24129-60002	C	
XREF	24223-60001	1523	2100/21MX CROSS REF TABLE GEN
F4D.N	24152-60001	C	RELO SUBRLIBR FTN4
F2E.N	24151-60001	D	RELO SUBR LIBR (EAU)
F2F.N	24248-60001	B	RELO SUBR LIBR (FP)
FFP.N	12907-16001	A	2100A/S FFP SUBR LIBRARY
\$SETP	12907-16002	1350	2100A/S FFP SUBR \$SETP
ATD01	24381-16001	1503	ASYNCH TERMINAL DRIVER No. 1
ATD02	24307-16012	1442	ASYNCH TERMINAL DRIVER No. 2
PMT01	24307-16008	1438	PAGE MODE TERMINAL DRIVER No. 1
PMT02	24307-16016	1503	PAGE MODE TERMINAL DRIVER No. 2
SLC	24307-16010	1438	SYNCHRONOUS LINE CONTROL DRIVER
DVR33	24278-60001	1419	2100/21MX WCS DRIVER
MASMB	24332-60001	1419	2100A/S WCS MICRO ASSEMBLER
WCSUT	24333-60001	A	2100/21MX MICRO UTILITIES
MDEBUG	24334-60001	1419	2100A/S WCS MICRO DEBUG EDITR
XASMB	12978-16001	1437	21MX WCS MICRO ASSEMBLER
XDEBUG	12978-16002	1437	21MX WCS MICRO DEBUG EDITOR
FFP.X	12977-16001	1451	21MX FFP SUBR LIBRARY
XSETP	12977-16002	1451	21MX FFP SUBR \$SETP

Update packages are free of charge. If you require an update package only, send your request to:

Software/Publications Distribution
11000 Wolfe Road
Cupertino, Ca. 95014

Customers in the U.S. may also order directly by mail. Simply list the name and part number of the manual(s) you need on the Corporate Parts Center form supplied at the back of the **Communicator**.

A few words about documentation terms:

New A new manual refers only to the first printing of a manual. When first printed, a manual is assigned a part number.

Revised A revised manual is a printing of an existing manual which incorporates new and/or changed information in its contents. For example, a manual is revised when an update package is incorporated into the manual: the manual gets a new print date and the update package disappears. Note that a revision to a manual effectively obsoletes the previous version of the manual.

Update An update package is a supplement to an existing manual which contains new and/or changed information. Updates are issued when information must get to customers, yet it is inappropriate to issue a revised manual. An update has no part number; it is automatically included when you order the manual with which it is associated.

documentation

The following tables list currently available customer manuals for Data Systems Division products. This list supersedes the list in the last issue of the **Communicator**.

The most recent changes to the tables are indicated for easy reference. Prices are subject to change without notice.

Copies of manuals and updates can be obtained from your local Sales and Service office. The address and telephone number of the office nearest to you are listed in the back of all customer manuals.

9600/9700 SYSTEM MANUALS

PART NUMBER	MANUAL TITLE	PRICE	DATE	UPDATE
02005-90001	Real-Time Executive Software System	\$12.00	10/71 *O	6/73
02313-93002	RTE 2313B Analog-Digital Interface Subsystem Operating and Service Manual	30.00	8/76	
02320-93002	RTE System Driver DVR76 for HP 2320A Low Speed Data Acquisition Subsystem Programming and Operating Manual	1.00	8/74	
02321-93001	RTE System Driver DVR74 for HP 2321A Low Speed Data Acquisition Subsystem Programming and Operating Manual	1.00	8/74	
09600-93010	RTE System DVR11 for HP 2892A Card Reader Programming and Operating Manual	1.00	8/74	
09600-93015	91200A TV Interface Kit; Programming and Operating Manual	4.50	7/75	1/76
09601-93007	RTE Device Subroutine for HP 5327A/B-H48 Counter	2.50	12/74	
09601-93009	RTE Device Subroutine for HP 5326A-H18 Counter	2.50	12/74	
09601-93014	RTE System Driver DVR15 Mark Sense Card Reader Programming and Operating Manual	1.00	2/76	
09601-93015	RTE for 40-bit Output Register #12556B	1.00	10/74	
09603-93001	9603A/9604A Control System and Scientific Measurement Operating and Service Manual	7.50	5/76	
09610-93003	ISA FORTRAN Extension Package Reference Manual	4.50	2/76	
09611-90009	9611A Operating 406 Industrial Measurement and Control System	.25	4/75	
09611-90010	HP 6940A/B Multiprogrammer Verification Manual	4.50	8/75	
12604-93002	RTE DVR40 for 12604B Data Source Interface	1.00	8/74	
12665-93001	RTE System Driver DVR65 for HP 12771A Computer Serial Interface Kit	1.00	8/74	
12989-99001	RTE System Driver DVA15 for Card Reader Punch Subsystem 2894	1.00	1/75	
24998-90001	DOS/RTE Relocatable Library Reference Manual	10.00	3/76	
25117-93003	RTE System Driver DVR24 for HP 7970 Series Digital Magnetic Tape Unit	1.00	8/74	
92063-90001	IMAGE/1000 Data Base Management System Reference Manual	9.00	6/76	
29003-93001	RTE System Driver DVR66 for HP 12772A Coupler Modem Interface Kit Programming and Operating Manual	1.00	8/74	
29003-93003	RTE System Driver DVR66 for HP 12770A Coupler Serial Interface Kit Programming and Operating Manual	1.00	8/74	
29009-93001	RTE System Driver DVR62 for HP 23138 Subsystem	2.50	8/74	
29013-90001	DVR31 RTE Moving Head Driver	10.00	2/73	
29014-90001	Moving Head Real-Time System Generator	20.00	4/72	
29015-90001	Fixed Head Real-Time System Generator	15.00	4/72	
29016-90002	RTE Scheduler <i>863-75</i>	50.00	9/72	
29016-90003	Real-Time Input/Output Control <i>863-75</i>	50.00	12/73	
29022-90001	Real-Time Relocating Loader	10.00	6/73	
29028-95001	RTE HP 2610A/2614A Line Printer Driver	1.50	8/73	
29029-91001	Real-Time Executive Multiple-Device System Control Device (DVR00) Program Listing	10.00	9/72	
29029-95001	Real-Time Executive System Driver DVR00 for Multiple Device System Control Small Programs Manual	1.50	11/75	
29033-98000	Real-Time Executive-File Manager System	10.00	3/73	
29100-93001	RTE System Driver DVR40 (29100-60041) for HP 12604B Data Source Interface Programming and Operating Manual	1.00	8/74	10/74
29100-93003	RTE System Driver DVR61 for HP 6940A, 6941A Bidirectional Multiprogrammer Programming and Operating Manual	3.00	3/76	
29101-93001	RTE Core-Based Software System Users Manual	10.00	1/76	
29102-93001	RTE BASIC Software System Programming and Operating Manual	10.00	3/74	8/75
29103-93001	RTE System Cross Loader; Programming and Operating Manual	2.50	3/75	11/75

*O = Obsolete Manual
 *R = Revised Manual
 *N = New Manual

about the HP 9600/9700

N/A obs.

obs

9600/9700 SYSTEM MANUALS (Continued)

about the HP 9600/9700

PART NUMBER	MANUAL TITLE	PRICE	DATE	UPDATE
91060-93005	RTE Driver for X-Y Display Storage Subsystem (HP Model 1331C-016) Programming and Operating Manual	1.00	8/74	
91062-93003	Real-Time Executive System Driver for DVM/Scanner Subsystem	9.00	8/74	
92001-93001	RTE-II Software System Programming and Operating Manual	10.00	3/76	
92060-90004	RTE-III Software System Programming and Operating Manual	12.00	3/76	
92060-90005	RTE Assembler Reference Manual	7.00	1/76	
92060-90009	RTE-III General Information Manual	4.00	2/76	
92060-90010	RTE Batch/Spool Monitor and Operating System Pocket Guide ←	3.00	10/75	← get status
92060-90012	RTE-III: A Guide for New Users	6.50	10/75	
92060-90013	Batch-Spool Monitor Reference Manual	9.50	12/75	3/76
92060-90014	RTE Interactive Editor Reference Manual	6.00	3/76	
92060-90016	Multi-User Real-Time BASIC Reference Manual	12.00	10/75	12/75
92200-93001	RTE System Driver DVR12 for HP 2607A Line Printer Programming and Operating Manual	1.00	3/74	
92200-93005	Real-Time Executive Operating System Drivers and Device Subroutine Manual	5.00	3/76	
92202-93001	RTE System Driver DVR23 for HP 7970 Series Digital Mag Tape Units Programming and Operating Manual	1.00	8/74	
93005-93005	Thermal Line Printer Subsystem for Driver DVR00 (RTE)	2.50	12/74	
93513-90002	RTE System Driver DVA 76-DVR40 for 2801 Quartz Thermometer System	1.50	4/75	

SOFTWARE INPUT/OUTPUT SYSTEM MANUALS

PART NUMBER	MANUAL TITLE	PRICE	DATE	UPDATE
02116-91760	Teleprinter Driver (LP Compatible) Manual	\$ 1.00	8/73	
02762-90002	HP 2762A Terminal Printer Driver	1.00	5/73	
02892-90003	HP 2892A Card Reader Driver	1.50	6/72	
12602-90022	Mark Sense Card Reader Drivers	1.00	6/70	
12653-90004	HP 2767 Line Printer Driver	1.00	9/70	1/73
12845-90005	HP 2610A/2614A Line Printer Driver	1.00	2/74	
12987-90006	HP 2607 Line Printer Driver	5.00	11/73	
13022-90010	HP 7970 Magnetic Tape Unit Driver	1.00	2/72	
13029-90010	Magnetic Tape Driver (7-Track)	1.00	2/72	
5950-9276	SIO Drum-Disc	1.00	2/70	
5951-1374	Software Input/Output System Configuration	1.00	7/74	
5951-1390	Subsystem Operation	2.00	2/76	
59310-90063	RTE DVR-37 459310 B Interface Bus Programming and Operating Manual	3.50		

*N = New Manual

BASIC CONTROL SYSTEM MANUALS

PART NUMBER	MANUAL TITLE	PRICE	DATE	UPDATE
02022-90014	Magnetic Tape Reformatting System Support Utilities	\$ 1.50	1/74	
02100-90129	HP 2100 Microassembler Coding Form	5.00		
02100-90140	Decimal String Arithmetic Routines	6.50	10/73	
02100-90200	Loader/Loader Reference Manual	2.00	5/76	
02108-90008	Microprogramming 21MX Computers Reference Manual	6.50	2/76	
02116-9017	Basic Control System Manual	8.50	12/71	
02116-9072	ALGOL for HP 2000 Computers Reference Manual	10.00	2/76	
02116-91751	Prepare Tape System	2.50	8/74	
02116-91752	Magnetic Tape System	6.00	6/71	
02116-91780	2100 Series Relocatable Subroutines	11.00	12/74	
02762-90003	HP 2762A Terminal Printer Driver	1.00	5/73	
02892-90004	HP 2892A Card Reader Driver	1.50	6/72	
12602-90021	Mark Sense Drivers	1.00	6/70	
12653-90005	HP 2767 Line Printer Driver	1.00	10/70	
12845-90004	HP 2610A/2614A Line Printer Driver	1.00	6/72	
12987-90008	HP 2607 Line Printer Driver	5.00	12/73	
13023-90010	HP 7970 Magnetic Tape Unit Driver	1.00	5/74	
13026-90010	Magnetic Tape Driver (7-Track without DMA)	1.00	5/71	6/72
13027-90010	Magnetic Tape Driver (7-Track with DMA)	1.00	5/71	6/72
5951-1371	HP 2100 Front Panel Procedures	1.00	8/73	
5951-1376	Basic Binary Loader/Disc Loader, Basic Moving-Head Disc Loader	1.00	4/76	
5951-1391	Basic Control System	1.50	10/74	
5951-1392	Magnetic Tape System	1.00	7/71	



DISC OPERATING SYSTEM MANUALS

PART NUMBER	MANUAL TITLE	PRICE	DATE	UPDATE
02767-90007	DOS/RTE 2767 Line Printer Driver	\$ 1.00	12/70	
12560-90023	DOS RTE and BCS Calcomp Plotter Drivers	1.50	10/75	
12602-90023	DOS/RTE Mark Sense Drivers Kit 12602B	1.00	8/70	
12908-90004	HP 12908 Writable Control Store Driver	1.00	2/75	
24307-90006	DOS-III Reference Manual	20.00	1/76	3/76
24307-90012	DOS-III Data Communications Drivers	7.50	4/76	
24307-90018	DOS-III Pocket Guide	3.50	12/75	
24307-90022	DOS-III Terminal Printer Driver	1.00	1/75	
24307-90073	DOS-III Standard Drivers	6.00	1/75	
24376-90001	IMAGE/2000 Data Base Management System Reference Manual	11.00	8/75	
5951-1366	Cross Reference Table Generator	1.00	8/74	
5951-1381	DOS-M/2000C Timeshared BASIC File Handler	1.00	5/71	
5951-1394	2000C File Interface for DOS-M	1.00	6/71	

LANGUAGE MANUALS

PART NUMBER	MANUAL TITLE	PRICE	DATE	UPDATE
02116-9014	HP Assembler Manual	\$ 6.50	8/75	
02116-9015	HP FORTRAN Manual	5.00	3/74	
02116-9016	Symbolic Editor	4.50	2/74	
02116-9072	ALGOL Reference Manual	10.00	2/76	
12907-90010	Implementing the HP 2100 Fast FORTRAN Processor	5.00	11/74	
24307-90014	DOS III Assembler Reference Manual	8.00	7/74	11/75
92060-90005	RTE Assembler Reference Manual	7.00	1/76	
5951-1321	HP FORTRAN IV Reference Manual	6.00	12/75	

about the HP 9600/9700

training schedule

The schedule for customer training courses on Data Systems Division products has been expanded to include courses offered at our European training centers. Listed below are courses offered in the U.S. and in Europe during the period September through December 1976.

You can also obtain a copy of the training schedule from your local HP sales office. A European course schedule is available through the sales offices in Europe; a U.S. schedule through U.S. sales offices.

*Prices quoted are for courses at the two U.S. training centers only. For prices of courses at European training centers please consult your local HP Sales Office.

Registration

Requests for enrollment in any of the above courses should be made through your local HP representative. He will supply the Training Registrar at the appropriate location

with the course number, dates, and requested motel reservations. Enrollments are acknowledged by a written confirmation indicating the Training Course, time of class, location and accommodations reserved.

Accommodations

Students provide their own transportation, meals and lodging. The Training Registrar will be pleased to assist in securing motel reservations at the time of registration.

Cancellations

In the event you are unable to attend a class for which you are registered please notify the Training Center Registrar immediately in order that we may offer your seat to another student.

Training Center Addresses

Cupertino
11000 Wolfe Road
Cupertino, California 95014
(408) 257-7000

Rockville
4 Choke Cherry Road
Rockville, Maryland 20850
(301) 948-6370

Boise
P. O. Box 15
15 N. Phillippi Street
Boise, Idaho 83707
(208) 376-6000
TWX: 910-970-5784

Boblingen
Kundenschulung
Herrenbergerstrasse 110
D-7030 Böblingen, Wurttemberg
Tel: (07031) 667-1
Telex: 07265739
Cable: HEPAG

Winnersh
King Street Lane
GB-Winnersh, Wokingham
Berks RG11 5AR.
Tel: Wokingham 784774
Cable: Hewpie London
Telex: 847 39

Grenoble
5, avenue Raymond-Chanas
38320 Eybens
Tel: (76) 25-81-41
Telex: 980124

Milan
Via Amerigo Vespucci, 2
1-20124 Milan
Tel: (2) 62 51
Cable: HEWPACKIT Milano
Telex: 32046

Madrid
Jerez No 3
E-Madrid 16
Tel: (1) 458 26 00
Telex: 23515 hpe

Stockholm
Enighetsvägen 1-3, Fack
S-161 20 Bromma 20
Tel: (08) 730 05 50
Cable: MEASUREMENTS
Stockholm
Telex: 10721

TITLE		TRAINING COURSE RATES AND CENTER LOCATION											
Course Number	Length	Price	Cupertino	Rockville	Boise	Boblingen	Winnersh	Grenoble	Milan	Madrid	Stockholm	Amsterdam/ Brus.	
22940A	2100 Maint.		10/11										
	10 days	\$1000											
22941A	21MX Maint.		9/27 12/6									9/13	
	5 days	500											
22942A	7900 Maint.		10/25 12/13									9/20 11/22	
	5 days	500											
22943A	7970B Maint.				9/13							9/27 11/29	
	5 days	600											
22944A	7970E Maint.				10/11								
	5 days	600											
22945A	7905 Maint.		10/4 11/1									10/11 12/13	
	5 days	500											
22950A	2100 Ser. Assm.		9/13 10/11 11/15 12/6	9/13 10/4 11/1 11/29		10/18 12/13	9/6 12/6	9/6 11/22	9/20 11/29	9/6	10/11 11/22	9/20 11/22	
	5 days	500											
22952A	DOS III B		11/1			10/25	9/13	10/18			10/18	12/13	
	5 days	500											
22952B	DOS III B								9/27				
	5 days	500											
22953A	2100 Image										10/25		
	3 days	300											
22959A	Assembler/21MX												
	5 days	500											
22960A	21MX Mic. Prog.		10/18 12/13					9/20	9/27				
	5 days	500											
22965B	RTE-II/III		9/13 9/27 10/11 10/25 11/8 11/29	9/20 10/11 11/8 12/6		* { 8/30 } { 9/6 }	* { 10/4 } { 10/11 }	* { 10/14 } { 12/23 }	* { 9/13 } { 9/20 }	* { 10/11 } { 10/18 }	* { 10/4 } { 10/11 }	* { 9/13 } { 9/20 }	* { 8/30 } { 9/6 }
	10 days	1000											
	(Course includes RTE-II/III operating system, batch spool monitor and file manager.)												
22968B	Measurement & control		10/14 12/13	12/20		10/21							
	2 days	200											
22969A	Distb. Sys.		10/25 12/13	9/13				11/15					
	5 days	500											
22977A	Image/DBMS 1000		9/27 11/8										
	5 days	500											

0076009700 about the HP 9600/9700

about the HP 9600/9700

Course Number	Length	Price	Cupertino	Rockville	Boise	Boblingen	Winnersh	Grenoble	Milan	Madrid	Stockholm	Amsterdam/ Bru.
22978	TCS		11/15									
	2 days	\$200										
22979A	Real/Time Multiterminal Basic		10/11 12/15	11/22		10/18					9/13 12/13	
	3 days	300										
22980	HPIB Multicomputer Bus Basic		9/27									
	3 days	300										
22981	HPIB Programming Under RTE		9/29									
	2 days	200										

NOTE: Dates within brackets are starting dates for week 1 and week 2 of the RTE course. In some cases there is a break between the two weeks of the class. Course 22977A, IMAGE/DBMS 1000 replaces 22953A (2100 IMAGE); the new class adds additional material and extends the training from 3 to 5 days.

Although every effort is made to insure the accuracy of the data presented in the **Communicator**, Hewlett-Packard cannot assume liability for the information contained herein.

Prices quoted apply only in U.S.A. If outside the U.S., contact your local sales and service office for prices in your country.

direct mail order form

To expedite your order for software, manuals, or other materials described in this publication, use this form to order directly from the Corporate Parts Center in Mountain View, California.

If you need assistance in placing your order, contact your local HP Sales Office.

1. Enter your name, address, customer reference number, and tax exemption information.
2. List the item or items you want by part number and description.
3. Compute the amount due and enclose a check or money order payable to Hewlett-Packard.



Computer Systems **Communicator**
 Subscription Service Manager
 Hewlett-Packard Company
 Mail Order Department
 P.O. Drawer No. 20
 Mountain View, California 94043
 U.S.A. September 1976

Bulk Rate
 U.S. Postage
PAID
 Sunnyvale, CA. 94086
 Permit No. 541

DEPT. PUBLIC WORKS
 KING ST. - MANLY VALE
 NEW SOUTH WALES
 AUSTRALIA

7081687

Address Correction Requested
 Forwarding and Return Postage Guaranteed